

TASCAM

D01419920C

RECORDER CONNECT

OWNER'S MANUAL

V1.1.1

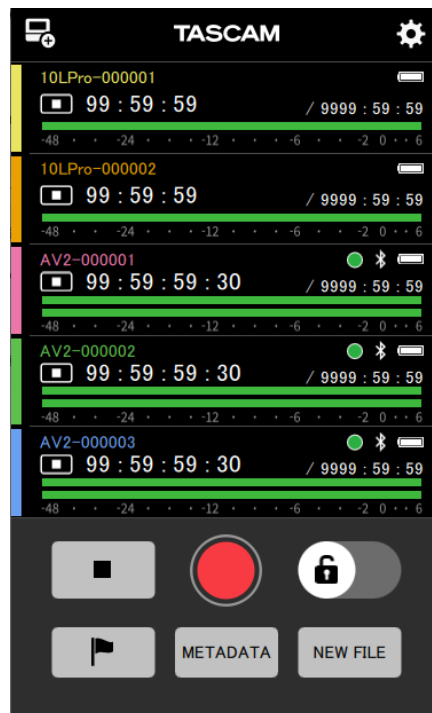

Contents

1. Introduction.....	3	10. File operations	50
1-1. Overview	3	10-1. BROWSE Screen.....	50
1-2. Operation requirements.....	3	10-2. Selecting files	50
iOS devices.....	3	10-3. Playing files quickly (FR-AV2 only)	51
Android devices.....	3	10-4. Showing file details	51
1-3. Conventions used in this manual	3	File Details Screen	51
1-4. Trademarks.....	4	10-5. Changing file names	52
2. Preparation	5	10-6. Setting file protection.....	52
2-1. Turning on the remote control function of the device...5		10-7. Deleting files	53
Enabling the remote control function of a DR-10L Pro...5		10-8. Working with folders (FR-AV2).....	54
Enabling the remote control function of an FR-AV2 ...5		Showing files inside a folder	54
2-2. Installing the dedicated control app	6	Changing folder names.....	54
2-3. Enabling the Bluetooth function on smartphones/ tablets.....	6	Deleting all files in a folder.....	55
2-4. Launching the dedicated controller app	6	Deleting folders	55
3. Connecting	7	11. Other useful functions.....	56
3-1. Connecting devices.....	7	11-1. Setting the HOLD function	56
3-2. Using demo mode	9	11-2. Synchronizing the time	56
4. Screen overview.....	10	11-3. Connecting wireless audio monitoring devices to different FR-AV2 units	57
4-1. Home Screen	10	11-4. Editing metadata	58
Home Screen structure	10	METADATA Screen.....	58
4-2. Individual device screens (DR-10L Pro).....	12	11-5. Identifying the unit being controlled	59
Structure of individual device screens.....	12	11-6. Setting the UNIT NAME.....	60
4-3. Individual device screens (FR-AV2).....	14	11-7. Setting the DEVICE COLOR	61
Structure of individual unit screens	14		
5. Recording and playing files	16		
5-1. Recording	16		
Recording with all units together	16		
Recording with individual units	17		
5-2. Starting playback.....	18		
6. Changing app settings.....	19		
6-1. APP SETTINGS Screen	19		
7. Changing settings for devices.....	21		
7-1. DEVICE SETTINGS Screen.....	21		
7-2. SETTINGS Screen (DR-10L Pro).....	22		
INPUT SETTINGS menu	22		
REC SETTINGS menu.....	25		
SYSTEM settings menu	28		
7-3. SETTINGS Screen (FR-AV2).....	36		
BLUETOOTH settings menu	37		
8. Preset functions	38		
8-1. Editing presets.....	38		
Editing presets	39		
Changing preset names	40		
Initializing presets	41		
8-2. Loading presets (DR-10L Pro only).....	42		
Loading presets to multiple DR-10L Pro units.....	42		
Loading presets to individual DR-10L Pro units	44		
9. Device settings functions	45		
9-1. Setting device data	45		
9-2. Removing device data	48		
Removing device data for all devices	48		
Removing data for individual devices	49		

1-1. Overview

TASCAM RECORDER CONNECT is an app for wireless control of TASCAM recorders (DR-10L Pro and FR-AV2). With this app, smartphones and tablets can be used to monitor and control the states of TASCAM recorders. Up to 5* TASCAM recorders can be connected at the same time. In addition to being operated independently, recording can be started and stopped for all connected recorders at the same time.

- TASCAM recorders can be easily set, controlled and monitored using a straightforward graphical interface on smartphones and tablets.
- Up to 5* TASCAM recorders can be monitored and their recording can be started and stopped at the same time. Different types can also be used at the same time.
- Input sounds can be monitored visually using waveform displays.
- Multiple TASCAM recorders can be given individual names and colors for easier management.
- Metadata (project names, scene names and take numbers) can be recorded as iXML data. This makes editing tasks more efficient.
- DR-10L Pro preset data can be saved in the app. Favorite unit settings can be recalled in an instant.
- Unit clocks are automatically synchronized with time data from the smartphone or tablet. Setting the time manually is unnecessary.

*The number of recorders could vary depending on the surrounding environment and radio wave conditions.

This app includes a demo mode allowing it to be tested even without a supported TASCAM recorder. Using TASCAM RECORDER CONNECT in demo mode allows users to check how it is operated and the settings that can be made. See "Using demo mode" on page 9 for details about demo mode.

Before using this app, read the Software Use License Agreement and agree to its terms.

1-2. Operation requirements

Check the TASCAM website for the latest information about supported operating systems.

<https://tascam.jp/int/>

Operation with each OS was confirmed with standard system setups that met the following conditions. Operation is not guaranteed, however, with all systems that meet the following conditions.

iOS devices

iOS 17/iPadOS 17

iOS 16/iPadOS 16

iOS 15/iPadOS 15

Android devices

Android 14

Android 13

Android 12

1-3. Conventions used in this manual

The following conventions are used in this manual.

- TASCAM RECORDER CONNECT is called "this app".
- TASCAM recorders that can be monitored and controlled with this app are called "devices", "units" or "recorders".
- Earphones and speakers that support Bluetooth are called "wireless audio monitoring devices".
- References to "iOS" in this document also include "iPad OS".
- Messages that appear on devices are shown in quotes like this: "OK".
- As necessary, additional information is provided under TIP, NOTE and CAUTION headings.

TIP

These are tips about how to use it.

NOTE

These provide additional explanations and describe special cases.

CAUTION

Failure to follow these instructions could result in damage to equipment or lost data, for example.

⚠ CAUTION

Failure to follow these instructions could result in injury.

1-4. Trademarks

- TASCAM is a registered trademark of TEAC Corporation.
- The Bluetooth® word mark and logo are the property of Bluetooth SIG, Inc. and are used by TEAC Corporation with permission.
- Android and Google are trademarks of Google LLC.
- Apple, Mac, macOS, iPad and the App Store are trademarks of Apple Inc. in the U.S. and other countries. The iPhone trademark is used under license from Aiphone Co., Ltd. The iPhone trademark is used under license from Aiphone Co., Ltd.
- App Store is a service mark of Apple Inc.
- IOS is a trademark or registered trademark of Cisco Systems, Inc. in the U.S. and other countries and is used under license.
- Other company names, product names and logos in this document are the trademarks or registered trademarks of their respective owners.

An iOS/Android device (smartphone or tablet) that supports Bluetooth device connection functions and a recorder with a Bluetooth adapter installed are necessary to use this app.

TIP

This app includes a demo mode allowing it to be tested even without a device.

This app can be used in demo mode to check how it is operated and the settings that can be made.

See “Using demo mode” on page 9 for details about demo mode.

NOTE

Referring to the Owner’s Manual for the device, install the Bluetooth adapter beforehand.

2-1. Turning on the remote control function of the device

Enabling the remote control function of a DR-10L Pro

Use the Menu Screen 25: BLUETOOTH item on the DR-10L Pro to set its remote control function.

1. When the Home Screen is open, press the MENU button.
The Menu Screen will open.

01:REC LEVEL

2. Use the \leftarrow [\sphericalangle] and \rightarrow [\sphericalangle] buttons to select 25: BLUETOOTH, and press the \blacktriangleright / \parallel [ENTER] button.

25:BLUETOOTH

3. Use the \leftarrow [\sphericalangle] and \rightarrow [\sphericalangle] buttons to select REMOTE, and press the \blacktriangleright / \parallel [ENTER] button.

<< REMOTE >>

NOTE

See the DR-10L Pro Owner’s Manual for details about operation procedures.

Enabling the remote control function of an FR-AV2

Use the Menu Screen BLUETOOTH item on the FR-AV2 to set its remote control function.

1. When the Home Screen is open, press the F1 [MENU] button.

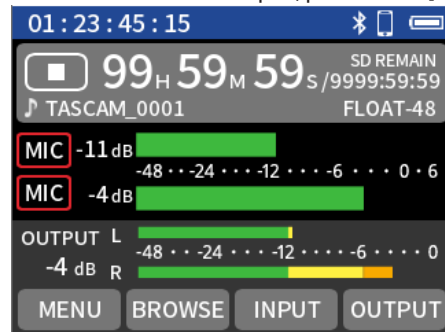

The Menu Screen will open.

2. BLUETOOTH > REMOTE CONTROL to “ON”.

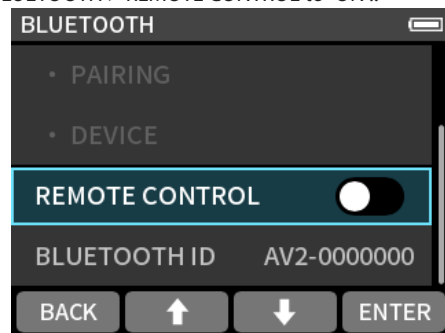

NOTE

See the FR-AV2 Owner’s Manual for details about operation procedures.

2. Preparation

2-2. Installing the dedicated control app

1. Connect the smartphone or tablet device to the Internet.
2. Search for "TASCAM RECORDER CONNECT" on Google Play for an Android device or on the App Store for an iOS device. Then, download and install it.

NOTE

- Please be aware that you are responsible for any transmission costs related to Internet connection.
- Refer to the operation manual of the device being used for procedures.

2-3. Enabling the Bluetooth function on smartphones/tablets

Enable the Bluetooth function on the smartphone or tablet.

CAUTION

- Do not execute pairing from the Bluetooth device list screen of the smartphone/tablet. If pairing has been conducted, remove the pairing. Always launch this app and then connect.
- When using an Android device, set Location to "On", and set "Location permission" for this app to "Allow" or "Allow only while in use".

NOTE

Refer to the operation manual of the device being used for procedures.

2-4. Launching the dedicated controller app

Use the smartphone or tablet to launch this app.



The following screen will appear after the app starts up.

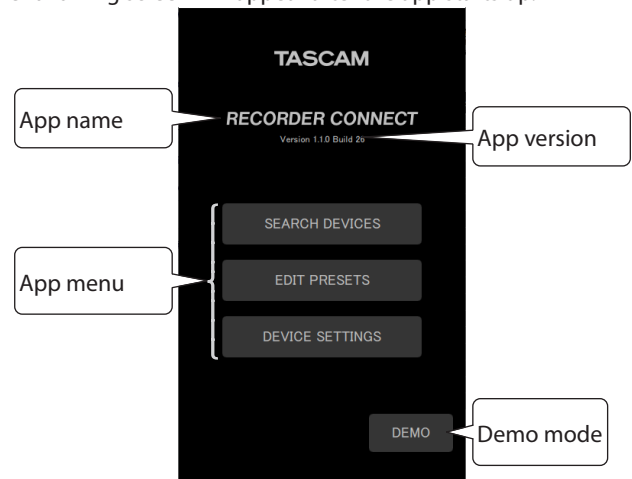

3-1. Connecting devices

1. Tap "SEARCH DEVICES" on the opening screen.

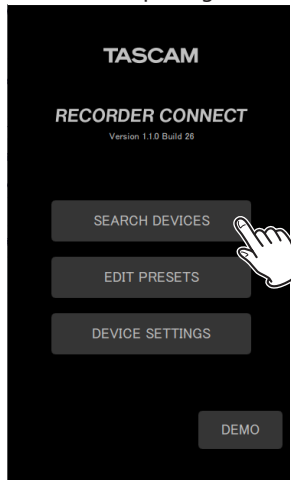

The following screen will appear.

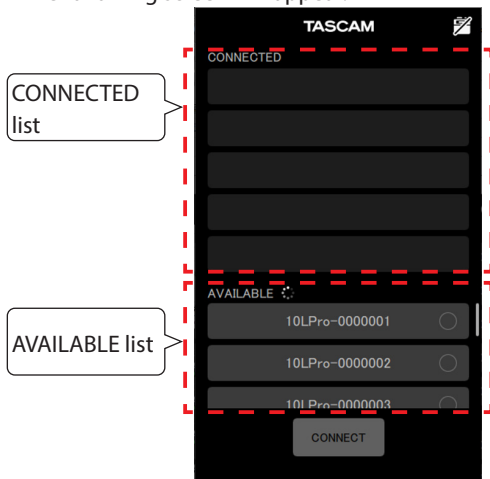

CONNECTED list	This shows the names of devices that are connected or in connection standby.
AVAILABLE list	If devices that can be connected are available, this shows their names.

NOTE

- The device name is shown as the UNIT NAME set in this app. The BLUETOOTH ID will be shown the first time that this app is launched or if a UNIT NAME has not been set.
- BLUETOOTH IDs can be checked with the following items on the Menu Screens of the devices.

DR-10L Pro	26: BT ID item on the recorder Menu Screen
FR-AV2	BLUETOOTH - BLUETOOTH ID item on the recorder Menu Screen

- See "Setting the UNIT NAME" on page 60 for UNIT NAME setting procedures.
- Since the app remembers the CONNECTED list, the previous state will be shown the next time it is launched.
- Devices that have been set in DEVICE SETTINGS will always be shown in the AVAILABLE list.
- New devices cannot be found if device data for 99 units has already been added. Device data can be removed from the DEVICE SETTINGS Screen to enable finding new devices. See "Removing device data" on page 48 for how to remove devices.

2. Tap the desired device in the AVAILABLE list to connect it.

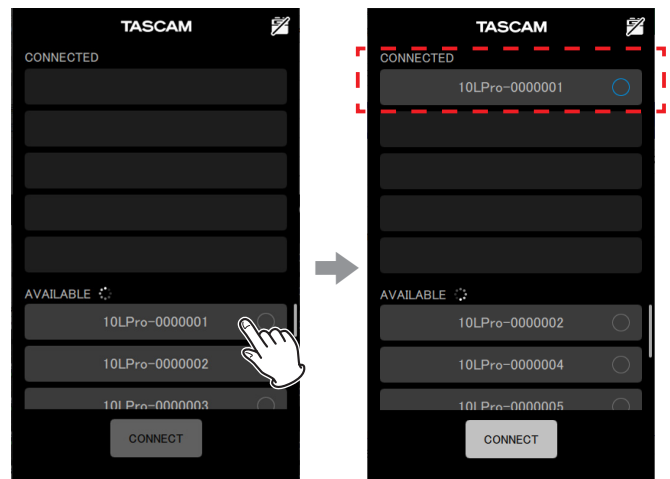

It will be added to the CONNECTED list.

NOTE

- Up to 5 devices can be added to the CONNECTED list.

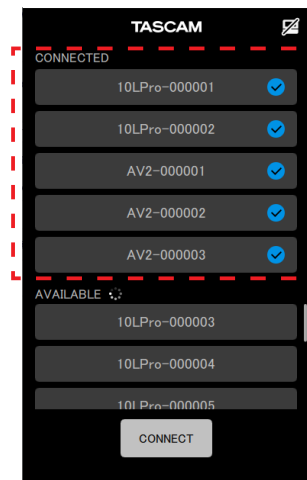

Example with 2 DR-10L Pro units and 3 FR-AV2 units added to the CONNECTED list

3. Connecting

- Tap a device shown in the CONNECTED list to move it to the AVAILABLE list.

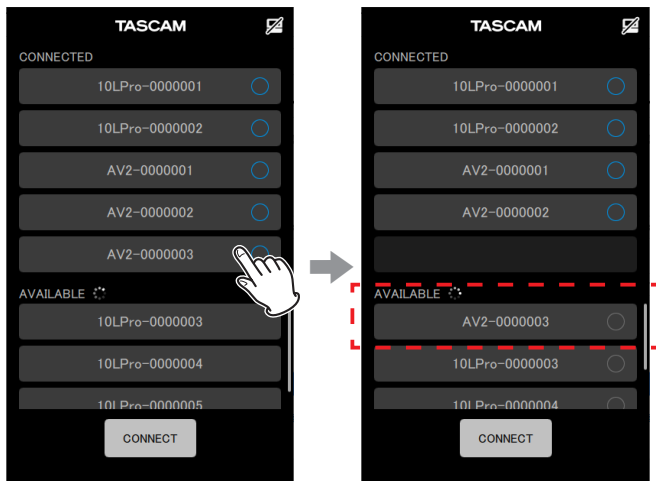

When a device is added to the CONNECTED list, it will begin connection standby and connection will automatically be attempted.

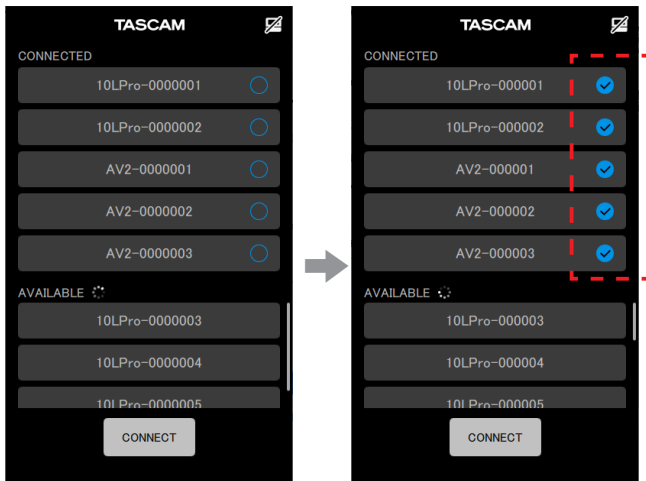

A check will appear when connection completes.

NOTE

- After connection completes, the UNIT NAME set in the app will be registered in the device.
- If a different UNIT NAME is already saved on the device, a confirmation pop-up message will appear.

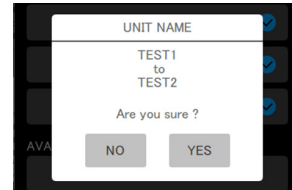

Example when the UNIT NAME in the app is "TEST1" and the UNIT NAME on the device is "TEST2"

NO	Set the app UNIT NAME ("TEST1") as the device name on the device.
YES	Set the device UNIT NAME ("TEST2") as the device name in the app.

- If a UNIT NAME has been set on the device but not in the app, the UNIT NAME set on the device will be added to the app settings.

3. Tap the **CONNECT** button.

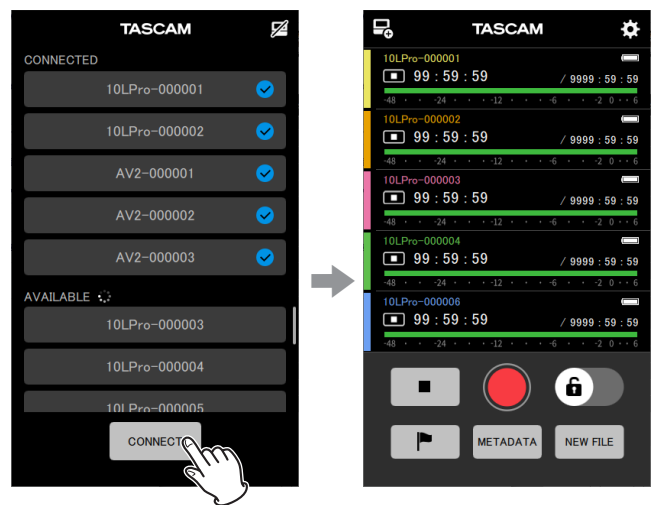

The Home Screen will appear.

3-2. Using demo mode

In demo mode, this app can be tried without a device. In demo mode, the CONNECTED and AVAILABLE lists, which would appear with the SEARCH DEVICES function, will be shown with pre-prepared virtual devices that can be connected.

NOTE

- When used in demo mode, device settings cannot be changed.
- Items and presets on the APP SETTINGS Screen (see “APP SETTINGS Screen” on page 19) can be edited in demo mode.

1. Tap “DEMO” on the opening screen.

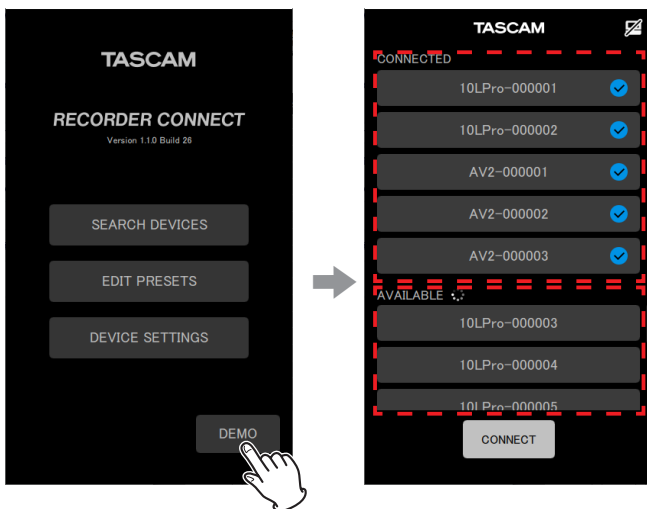

Virtual devices that can be connected will be shown in the CONNECTED and AVAILABLE lists.

NOTE

- In demo mode, 2 DR-10L Pro units and 3 FR-AV2 will have been connected and be shown in the CONNECTED list.
- Tap a device shown in the CONNECTED list to move it to the AVAILABLE list.

2. Tap the **CONNECT** button.

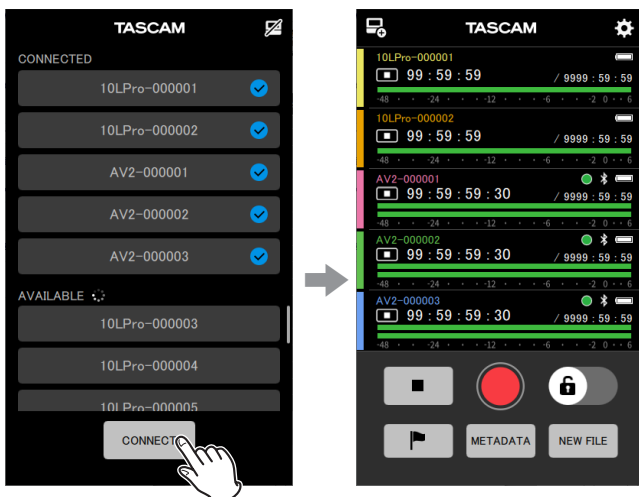

The Home Screen will appear.

4. Screen overview

4-1. Home Screen

All connected devices can be operated from the Home Screen.

Home Screen structure

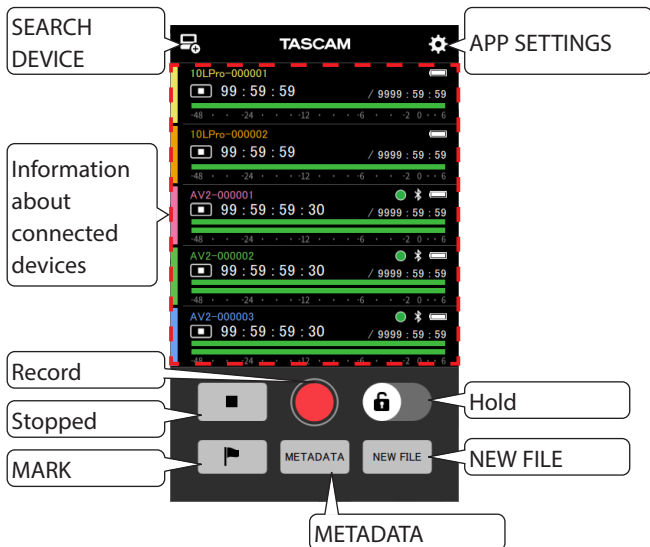



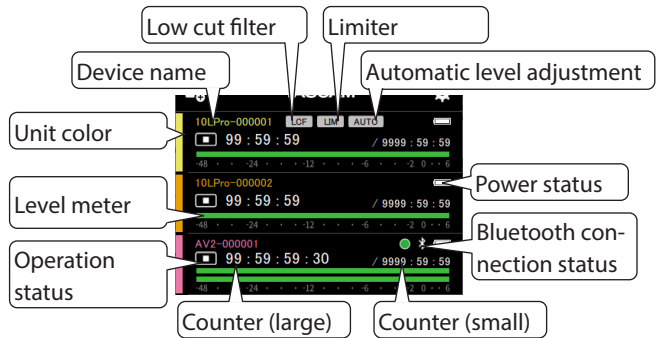

SEARCH DEVICE	This opens the Device Selection Screen.
APP SETTINGS	This opens the APP SETTINGS Screen.
Information about units	This shows the status of connected devices (up to 5 units). Tap these areas to open screens for the individual units.
button	Start recording with every connected unit.
button	Stop recording with every connected unit.
button	Add marks with every connected unit.
button	Press and hold this to turn on/off the hold function, which disables app operations. This is independent from the hold functions of the individual hardware units.
button	Press this when recording to start recording a new file.
button	This opens a screen where iXML data for all the connected units can be edited.

Information about units on the Home Screen

This shows the status of connected devices (up to 5 units).



Device name	This shows the device name. If UNIT NAME* is set, it will be shown as the device name. Characters will be shown using the colors* set for each device.
Unit color	This shows the color* set for the device.
Level meter	When set to 16/24-bit: up to 0 dB shown When set to 32-bit float: up to +6 dB shown This will appear red during analog clipping.
Operation status	This shows the operation status of the unit. : Stopped : Recording : Playing : Paused : Searching forward : Searching backward
Counter (large)	When stopped: This shows the total file time When recording/playing back: This shows the elapsed time When operating with timecode, this always shows timecode.
Counter (small)	When stopped/recording: This shows the remaining card capacity When playing back: This shows the total file time
Low cut**	: This appears when the LOW CUT setting is on.
Limiter**	: This appears when the LIMITER setting is on.
Auto level**	: This appears when the AUTO LEVEL setting is on.

Phantom***	+48V1/+48V2 or +24V1/+24V2: This appears when the phantom power setting is on.
FX***	FX1/FX2: These are shown when the input effects are on.
Power status	This shows the status of the power supply.  : Batteries are in use. The battery icon shows the remaining power.  : USB bus power is in use.
Bluetooth connection status	 This is shown when the wireless audio monitoring functions is on***  : Running by itself based on the last received timecode  : Synchronized based on received timecode

* The UNIT NAME and device color are set on the DEVICE SETTINGS Screen of the individual unit. (see “DEVICE SETTINGS Screen” on page 21)

** This is shown when the connected device is a DR-10L Pro.

*** This is shown when the connected device is a FR-AV2.

Appearance while connecting

When connection interrupted

A device will appear gray when it is connecting or when its connection has been interrupted.

Tap a device shown with a  mark to try reconnecting it.

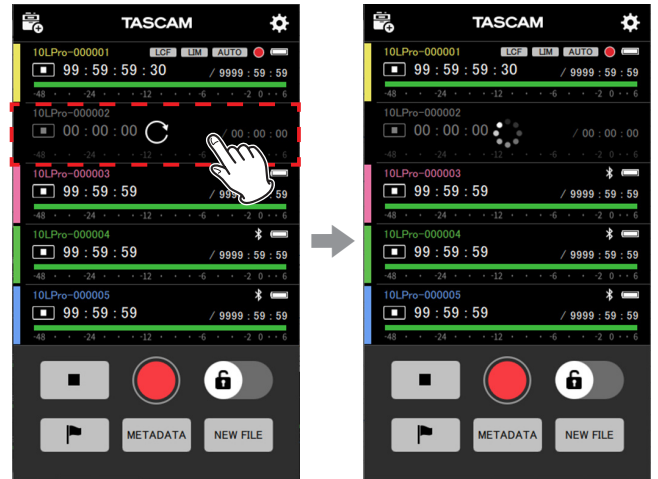

The 2nd DR-10L Pro appears gray

Connecting

Tap an individual unit to open its screen.



Home Screen

Individual unit screen

See “Individual device screens (DR-10L Pro)” on page 12 and “Individual device screens (FR-AV2)” on page 14 for details about individual device screens.

Warning indicators

A  will appear if trouble occurs when connecting with a device.

Tap a device shown with a  mark to open a pop-up message.

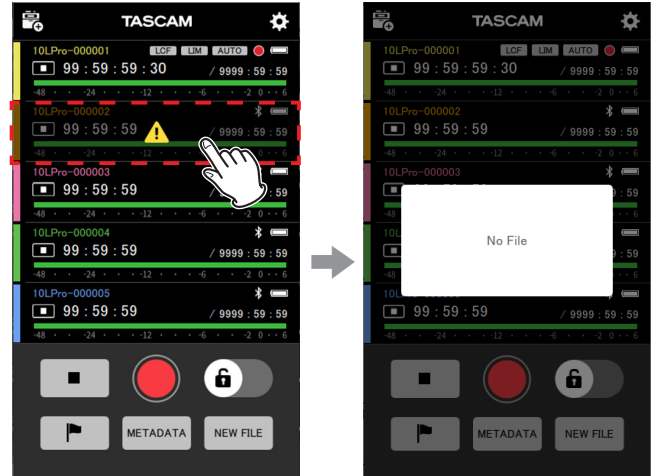



 appears on the 2nd device

Pop-up message

The pop-up window will be shown for about 2 seconds.

4. Screen overview

Error indicators

A  will appear if an error occurs when connecting with a device. Tap a device shown with a  mark to open a pop-up message.

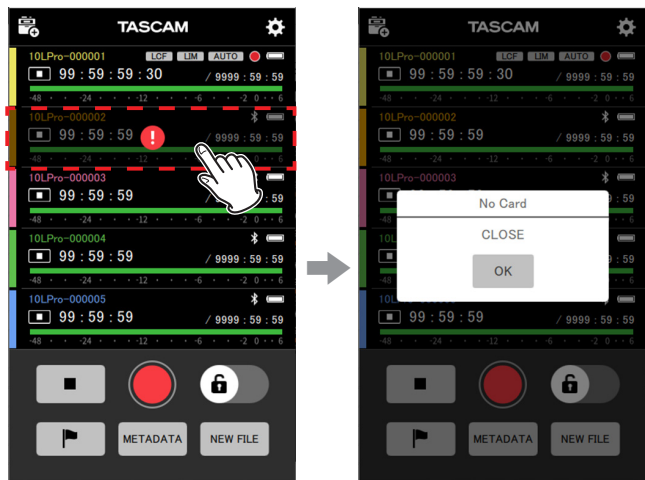

A  appears on the 2nd device

Pop-up message

See the message list in the Owner's Manual of the device for details about pop-up messages and respond accordingly.

Appearance when setting marks

Tapping the  button will open a MARK SET pop up from the bottom of the screen. The pop-up will close after about 2 seconds.

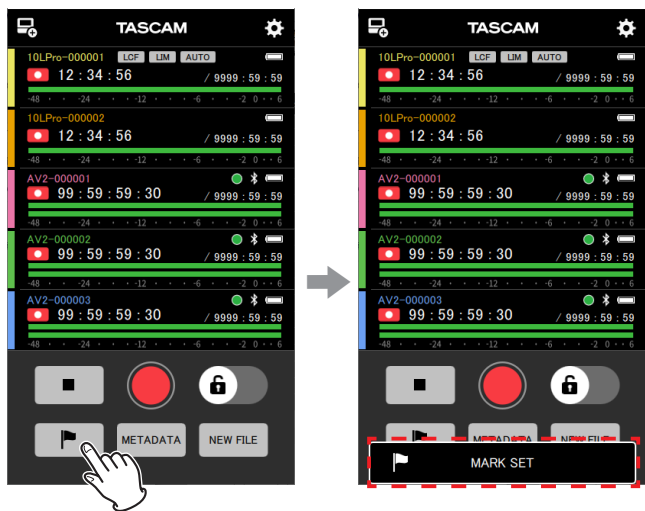





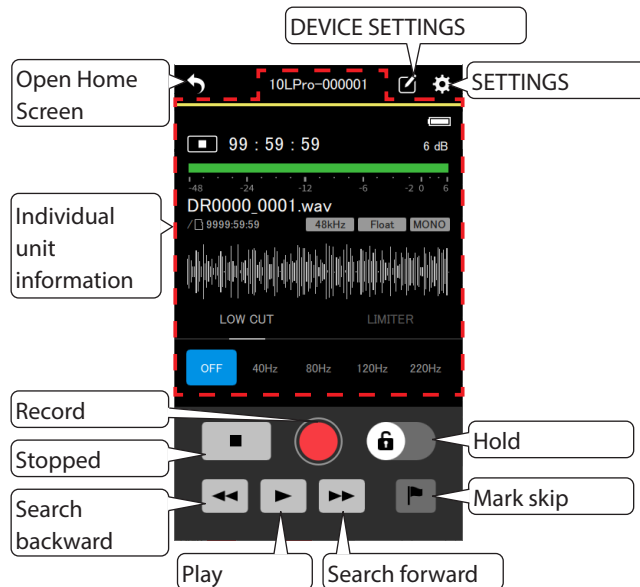

4-2. Individual device screens (DR-10L Pro)

On individual unit screens, only the unit shown can be operated.

Structure of individual device screens



Open Home Screen	This opens the Home Screen.
DEVICE SETTINGS	This opens a screen for setting the unit name and color of the DR-10L Pro being shown.
SETTINGS	This opens a screen for making recording, input and system settings for the unit being shown.
Individual unit information	This shows the status of the unit being shown.
 button	This starts recording with the unit being shown.
 button	This stops recording with the unit being shown.
 button	Press and hold this to turn on/off the hold function, which disables app operations. This is independent from the hold functions of hardware units.
 button	This starts searching forward with the unit being shown.
 button	This starts searching backward with the unit being shown.
 button	This starts playback with the unit being shown.
 button	This turns the MARK SKIP function on and off.

Information about the unit on the individual unit screen

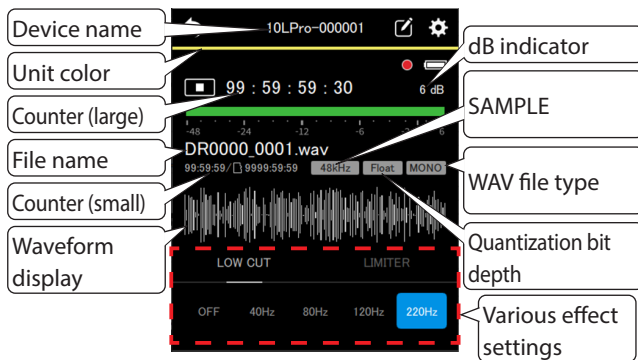

SAMPLE	This shows the sampling frequency of the file being played/recorded. 44.1kHz : 44.1 kHz 48kHz : 48 kHz
WAV file type	This shows the type of WAV file being played/recorded. MONO : Mono file POLY : Stereo file
Quantization bit depth	This shows the quantization bit depth of the file being played/recorded. 16bit : 16-bit 24bit : 24-bit Float : 32-bit float

Device name	This shows the device name. If UNIT NAME* is set, it will be shown as the device name.
Unit color	This shows the color* set for the device.
Counter (large)	When stopped: This shows the total file time. When recording/playing back: This shows the elapsed time. When operating with timecode, this always shows timecode.
File name	This shows the name of the file being recorded or played.
Counter (small)	When stopped/recording: This shows the remaining card capacity. When playing back: This shows the total file time. In addition to the above, the following will also be shown when operating with timecode. When stopped: This shows the total file time. When recording/playing back: This shows the elapsed time.
Waveform display**	The waveform is shown in real time when stopped or recording. The waveform of the entire file is shown when playing or paused. The waveform can be touched to locate to a playback position.
Various effect settings	Various effects settings can be shown and changed. Operation is not possible during playback.
dB indicator	This shows the dB during recording/playback.

* The UNIT NAME and recorder color are set on the DEVICE SETTINGS Screen of the individual unit. (see "DEVICE SETTINGS Screen" on page 21)

** Waveforms cannot be shown for imported files.

4. Screen overview

4-3. Individual device screens (FR-AV2)

On individual unit screens, only the unit shown can be operated.

Structure of individual unit screens

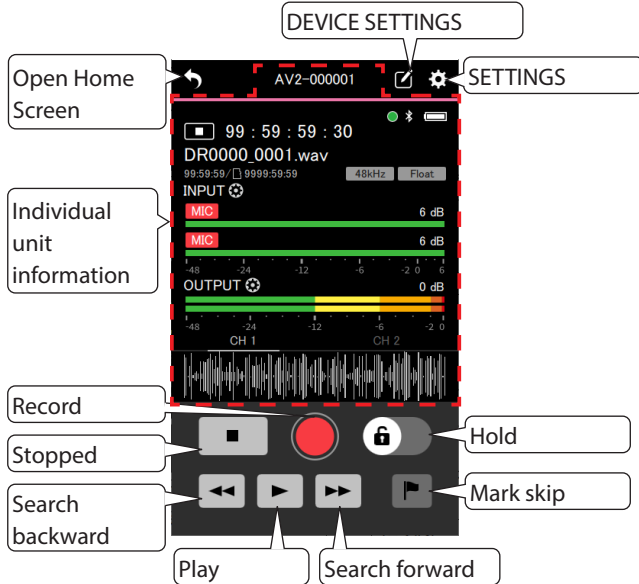

Open Home Screen	This opens the Home Screen.
DEVICE SETTINGS	This opens a screen for setting the unit name and color of the FR-AV2 being shown.
SETTINGS	This opens a screen for making recording, input and system settings for the unit being shown.
Individual unit information	This shows the status of the unit being shown.
button	This starts recording with the unit being shown.
button	This stops recording with the unit being shown.
button	Press and hold this to turn on/off the hold function, which disables app operations. This is independent from the hold functions of hardware units.
button	This starts searching forward with the unit being shown.
button	This starts searching backward with the unit being shown.
button	This starts playback with the unit being shown.
button	This turns the MARK SKIP function on and off.

Information about the unit on the individual unit screen

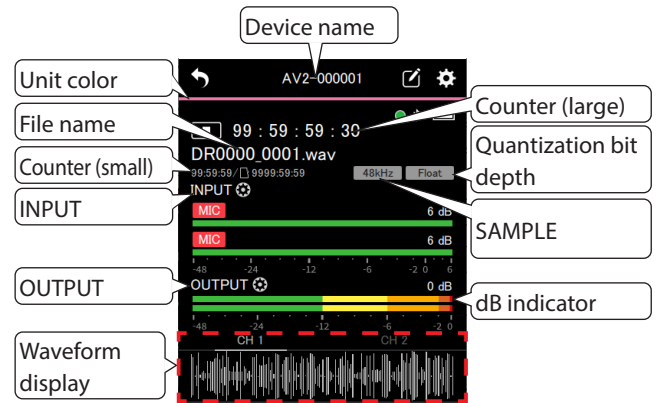

Device name	This shows the device name. If UNIT NAME* is set, it will be shown as the device name.
Unit color	This shows the color* set for the device.
Counter (large)	When stopped: This shows the total file time. When recording/playing back: This shows the elapsed time. When operating with timecode, this always shows timecode.
File name	This shows the name of the file being recorded or played.
Counter (small)	When stopped/recording: This shows the remaining card capacity. When playing back: This shows the total file time. In addition to the above, the following will also be shown when operating with timecode. When stopped: This shows the total file time. When recording/playing back: This shows the elapsed time.
INPUT	Open the INPUT SETTINGS screen
OUTPUT	Open the OUTPUT SETTINGS screen
Waveform display**	The waveform is shown in real time when stopped or recording. The waveform of the entire file is shown when playing or paused. The waveform can be touched to locate to a playback position.
dB indicator	This shows the dB during recording/ playback.

SAMPLE	<p>This shows the sampling frequency of the file being played/recorded.</p> <p>48kHz 48 kHz</p> <p>96kHz 96 kHz</p> <p>192kHz 192 kHz</p>
Quantization bit depth	<p>This shows the quantization bit depth of the file being played/recorded.</p> <p>24bit 24-bit</p> <p>Float 32-bit float</p>

* The UNIT NAME and recorder color are set on the DEVICE SETTINGS Screen of the individual unit. (see “DEVICE SETTINGS Screen” on page 21)

** Waveforms cannot be shown for imported files.

INPUT and OUTPUT settings screens

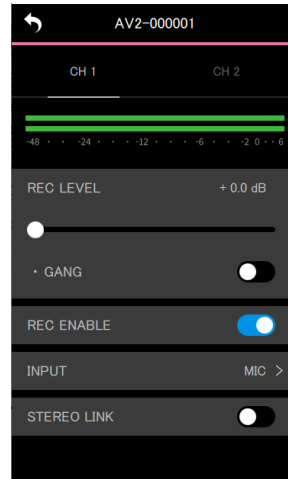

INPUT screen

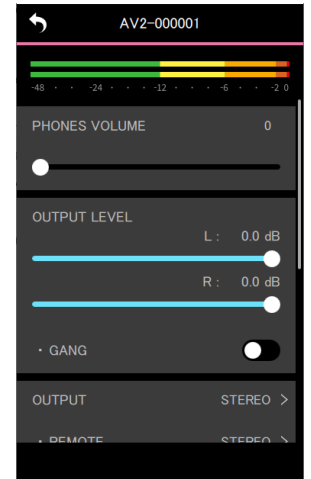

OUTPUT screen

Various input and output settings for the FR-AV2 can be changed as on the device itself.

See the FR-AV2 Owner’s Manual for details about setting items and setting procedures.

NOTE

INPUT settings cannot be changed during playback.

5. Recording and playing files

5-1. Recording

This app can be used to control recording operations for all connected devices at once and for individual units.

Recording with all units together

Tap the  button on the Home Screen.

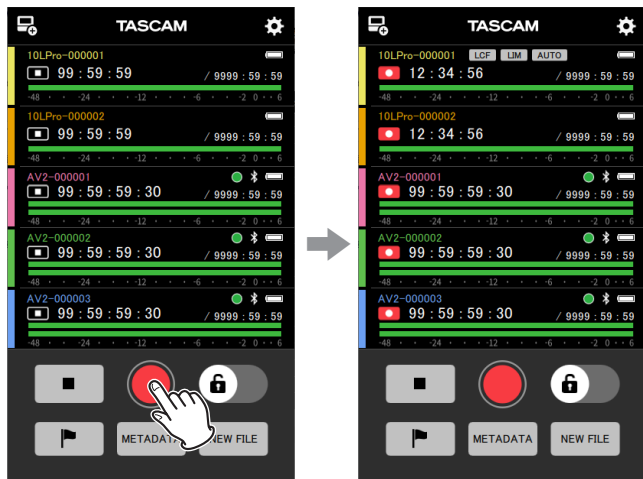

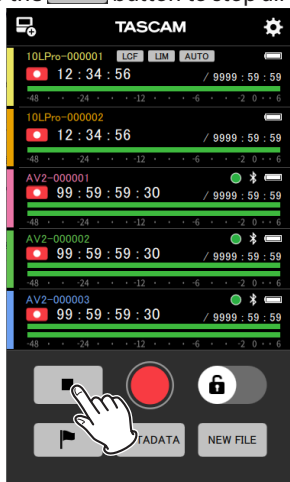

This starts recording with all units.

Tap the  button to stop all units together.



NOTE

- Units that are not connected cannot be controlled.
-  will appear if trouble occurs with a device, and  will appear if an error occurs with a device. Tap a unit that is showing a trouble or error icon to open a pop-up message with details.
- Tap the  button during recording to add mark data to the recording files on all devices.

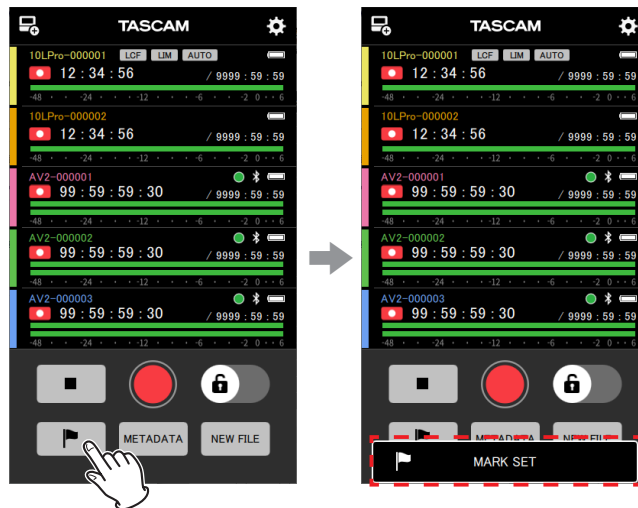

- Tap the  button when recording to start recording in a new file.

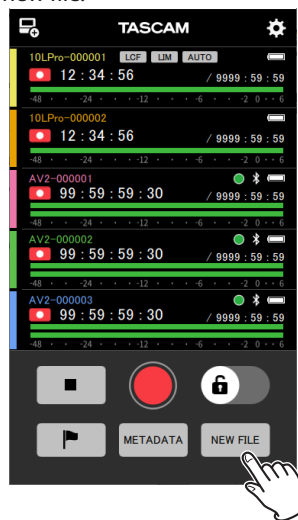

Recording with individual units

1. Tap the unit to use for recording on the Home Screen.

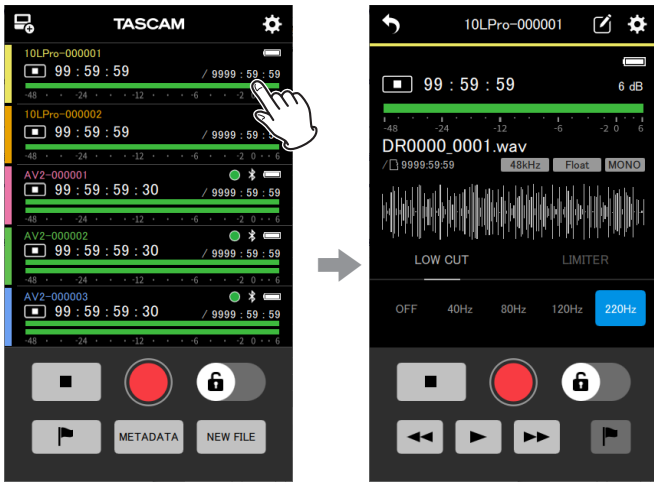

This will open the screen for an individual unit (a DR-10L Pro in this example).

2. Tap the  button on the individual device screen.



This starts recording with the unit being shown.

Tap the  button to stop recording.

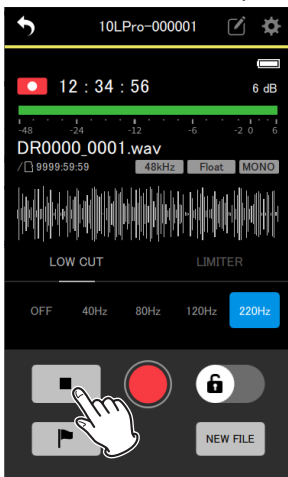

NOTE

- Tap the  button during recording to add mark data to the recording file on the shown device.



- Tap the  button when recording to start recording in a new file.

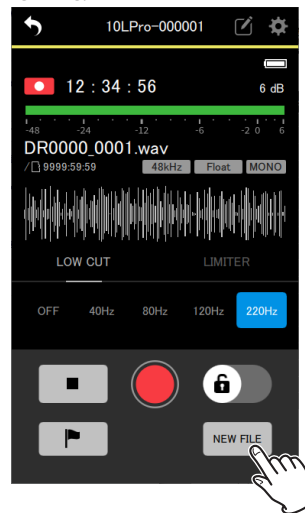

5. Recording and playing files

5-2. Starting playback

This app can control playback operations only for individual units.

1. Tap the unit to use for playback on the Home Screen.

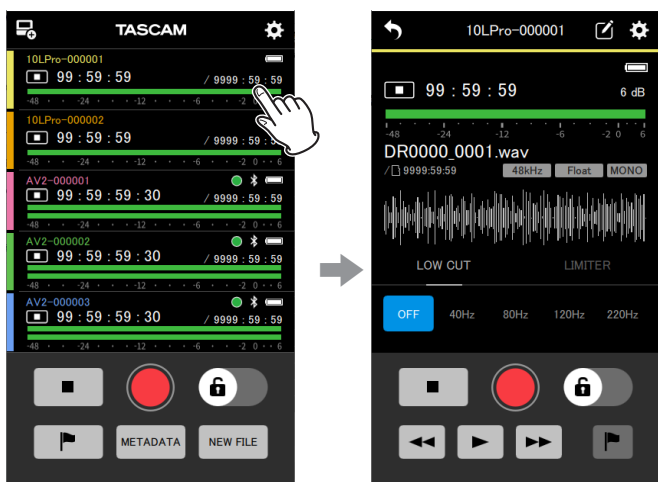

This will open the screen for an individual unit (a DR-10L Pro in this example).

2. Tap the  button on the individual device screen being shown.



This starts playback on the unit being shown.

NOTE

If you want to conduct playback on another connected unit, return to the Home Screen after step 2, select the other unit and repeat from step 1.

During playback, the  button changes to the  button.







Tap the  button to pause playback.



Tap the  button to stop playback.



TIP

- Press and hold the  /  button to search backward/forward.
- Tap the  button to open the next file.
- Tap the  button to conduct the following operations.
 - Move to the beginning of the file if the playback position is in the middle of a file.
 - Move to the previous file if the playback position is at the beginning of a file.
- When mark skipping is on () , press the  /  button to skip to the previous/next mark position.

NOTE

- The playback position shown on the waveform can be swiped to move it to the desired point.
- Waveforms cannot be shown for imported files.
- To select a file for playback, use the BROWSE Screen (see "BROWSE Screen" on page 50).
- Setting screens cannot be operated during playback.

6. Changing app settings

Open the APP SETTINGS from the Home Screen to change app settings.

Tap the  icon at the top right of the Home Screen.

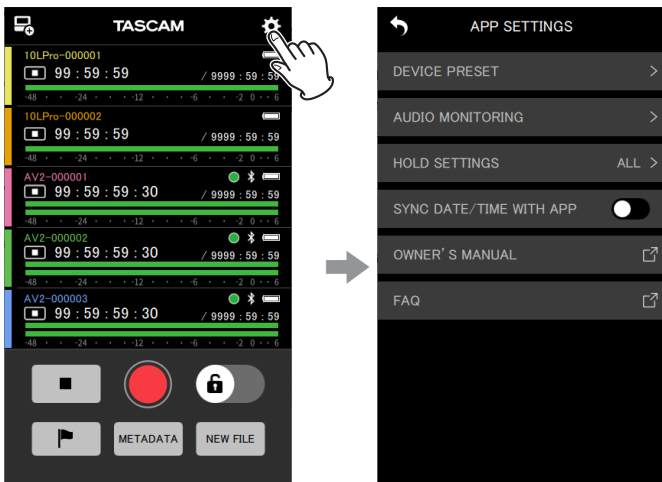

This opens the APP SETTINGS Screen.

6-1. APP SETTINGS Screen

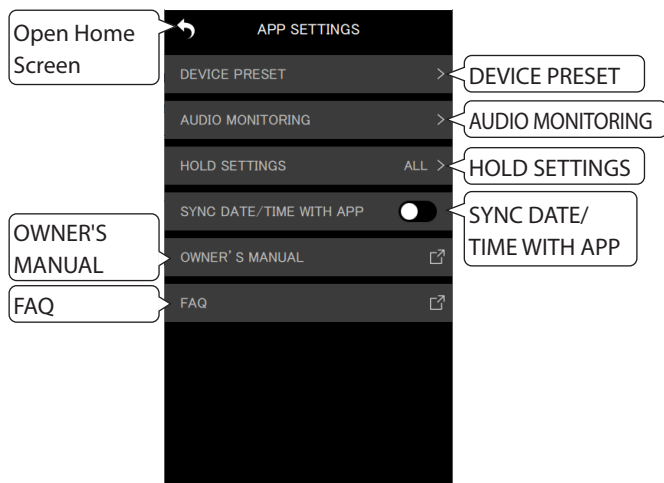

DEVICE PRESET

This opens the PRESET LIBRARY Screen where DR-10L Pro presets can be edited and recalled.

By recalling presets that have been edited, settings can be applied to any DR-10L Pro.

NOTE

Presets can be edited even when no DR-10L Pro is connected. Presets can only be loaded from connected DR-10L Pro units.

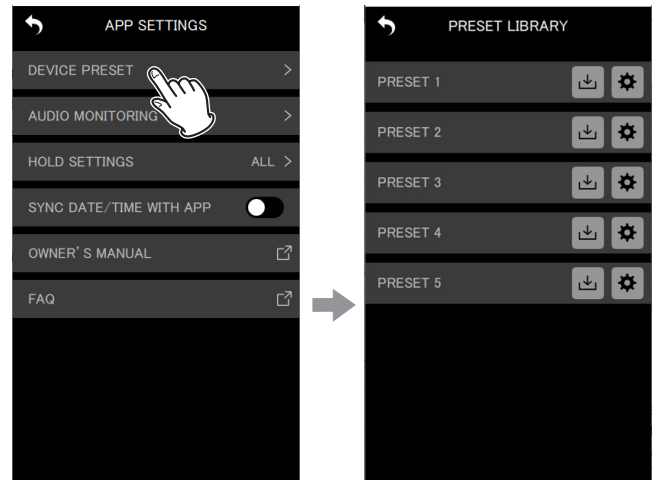

Editing presets

Tap the  icon to the right of the preset you want to edit.

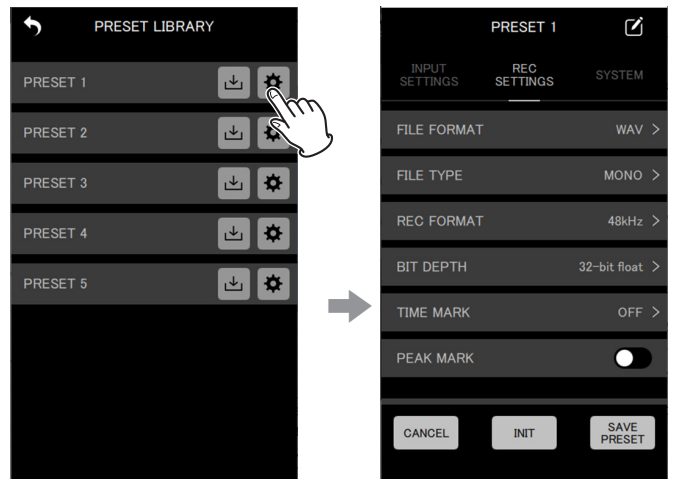

This will open the preset editing screen.

See "Editing presets" on page 38 for details about how to edit presets.

6. Changing app settings

Loading presets

Tap the  icon to the right of the preset you want to load.

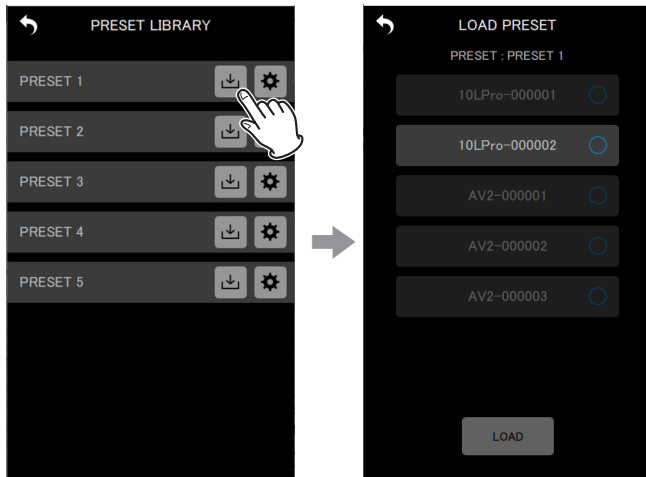

This will open the LOAD PRESET Screen.

See “Loading presets (DR-10L Pro only)” on page 42 for details about how to load presets.

AUDIO MONITORING

This opens the MONITOR SELECT screen for AUDIO MONITORING. By turning on/off the wireless audio monitoring functions for an FR-AV2 on the MONITOR SELECT screen, a connected wireless audio monitoring device can be reconnected to a different FR-AV2. See “Connecting wireless audio monitoring devices to different FR-AV2 units” on page 57 for details.

HOLD SETTINGS

By setting the HOLD function, recording and playback misoperation can be prevented while monitoring and changing settings for each unit.

See “Setting the HOLD function” on page 56 for details.

SYNC DATE/TIME WITH APP

By enabling this automatic time synchronization function, time data from the device can be applied to recorders. (This is on by default.)

See “Synchronizing the time” on page 56 for details.

OWNER'S MANUAL

This will open an external link to the Owner’s Manual for the recorder.

The manual will be shown at the external link.*

FAQ

This will open an external link to an FAQ for the recorder.

The FAQ will be shown at the external link.*

* The external link will be opened in the web browser designated by the device.

7. Changing settings for devices

The settings of connected devices can be changed from this app. No operations are necessary on the devices themselves. Settings can be changed on the DEVICE SETTINGS and SETTINGS screens for individual units.

DEVICE SETTINGS

Tap the  icon at the top right of the Home Screen.

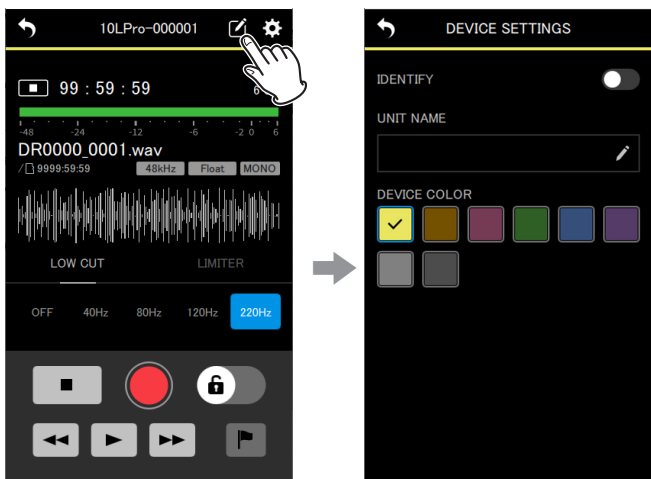

This opens the DEVICE SETTINGS Screen. (see “DEVICE SETTINGS Screen” on page 21)

SETTINGS

Tap the  icon at the top right of the Home Screen.



This opens the SETTINGS Screen. (see “SETTINGS Screen (DR-10L Pro)” on page 22) (see “SETTINGS Screen (FR-AV2)” on page 36)

7-1. DEVICE SETTINGS Screen

On the DEVICE SETTINGS Screen, the UNIT NAME and DEVICE COLOR can be set for the device shown. That device can also be identified by making its display blink.

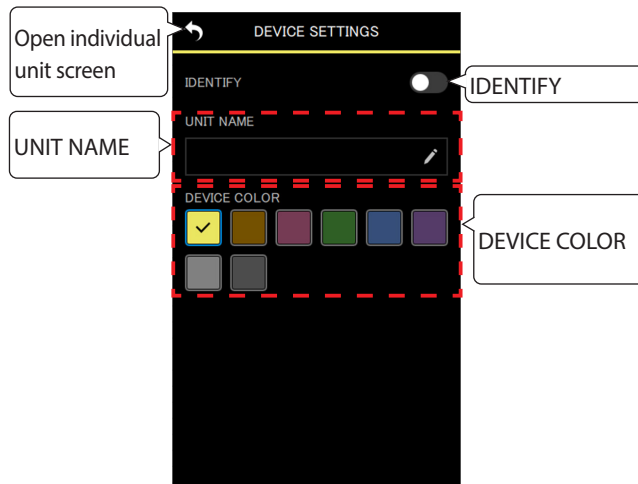

IDENTIFY

This causes the device display to blink, enabling confirmation of the unit being controlled.

See “Identifying the unit being controlled” on page 59 for details.

UNIT NAME

The UNIT NAME can be set to give the unit the desired name.

TIP

When recording a TV drama or play, for example, setting UNIT NAME to the individual names of each performer can make identification easier when managing files and editing. See “Setting the UNIT NAME” on page 60 for details.

DEVICE COLOR

Colors can be selected and set for each unit.

The DEVICE COLOR is used for various device indications on the Home Screen and the individual unit screen.



See “Setting the DEVICE COLOR” on page 61 for details.

7. Changing settings for devices

7-2. SETTINGS Screen (DR-10L Pro)

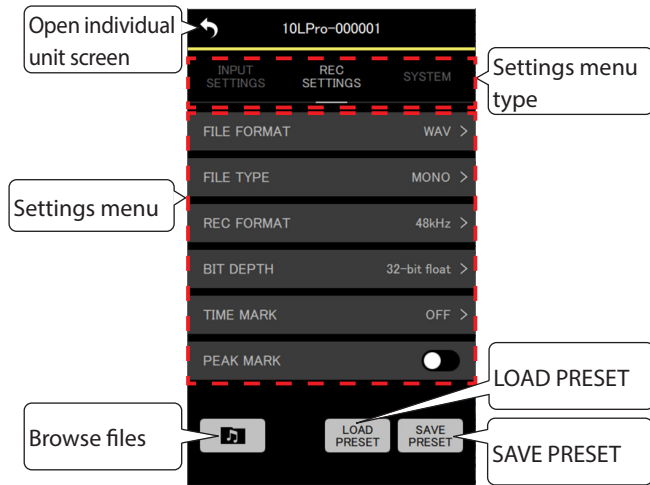
On the SETTINGS Screen, input, recording and system settings can be changed.



Settings menu type	Tap a type of settings menu to show the corresponding settings. The title of the menu being shown will have white characters and a white underline.
Settings menu	Setting items are shown for the open settings menu type.
 button	This opens the BROWSE Screen. (see "BROWSE Screen" on page 50) Operations can be conducted for the files on the unit being shown.
 button	Presets can be loaded onto the unit being shown.
 button	The settings of the unit being shown can be saved as a preset.

NOTE

On the SETTINGS Screen, presets can be recalled and applied to the settings of the unit being shown. In addition, the current settings can be saved as a preset.

INPUT SETTINGS menu

REC LEVEL

Use to set the audio signal level recorded in recording files.

Setting items (default value underlined)
HIGH / HIGH-MID / MID / MID-LOW / LOW

1. Tap the setting menu.

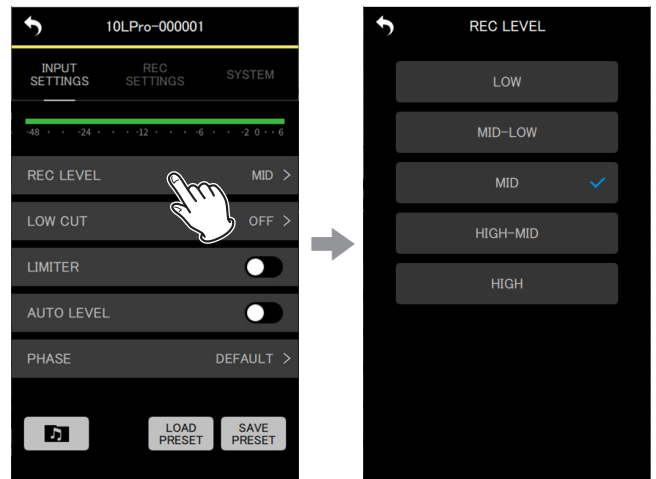

The setting items screen will open.

2. Tap a setting item.

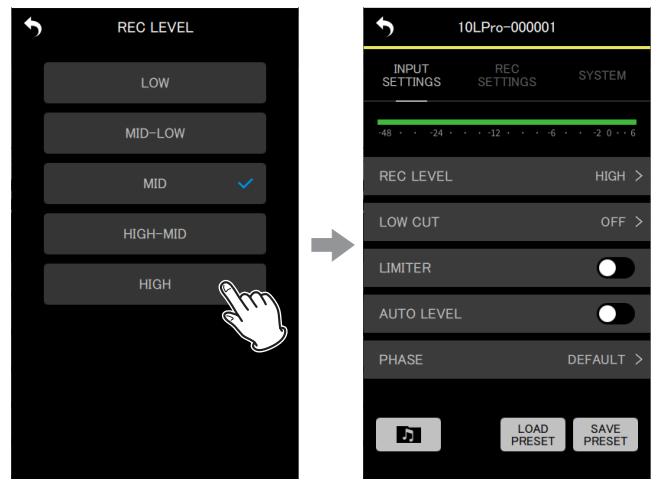

The change will be applied and the INPUT SETTINGS menu screen will reopen.

Change the setting so that the level meter exceeds the center slightly.

NOTE

If the AUTO LEVEL item is set to ON, it will be reset to OFF when the REC LEVEL setting is changed.

When this happens, "AUTO LVL Cancel" will appear in a pop-up message.

To use the auto level function, after setting the REC LEVEL item, set the AUTO LEVEL item to ON again.

LOW CUT

The cutoff frequency of the low-cut filter used on the mic input can be set.

This cuts audio below the selected frequency.

The low-cut filter can reduce bothersome noise, such as from wind, air-conditioners and projectors.

Set the cutoff frequency of the low-cut filter to match the noise.

Setting items (default value underlined)

OFF / 40Hz / 80Hz / 120Hz / 220Hz

1. Tap the setting menu.



The setting items screen will open.

2. Tap a setting item.

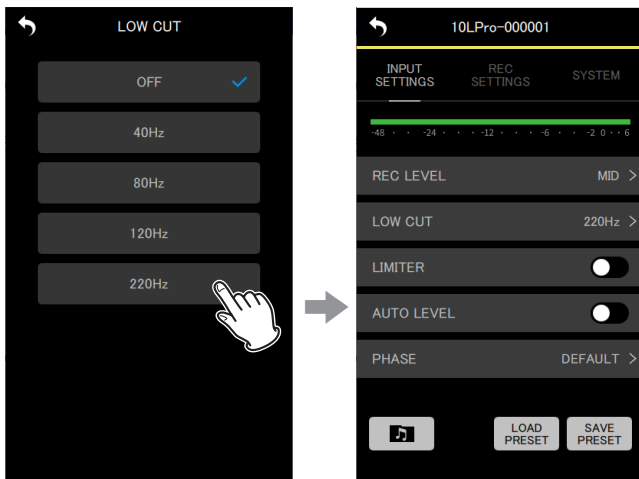

The change will be applied and the INPUT SETTINGS menu screen will reopen.

NOTE

LOW CUT can also be set in the effects settings on individual unit screens (see "Individual device screens (DR-10L Pro)" on page 12).

LIMITER

The limiter prevents distortion when signals that are too loud are input suddenly.

Setting items (default value underlined)

OFF / ON

Tap this to turn it on/off.

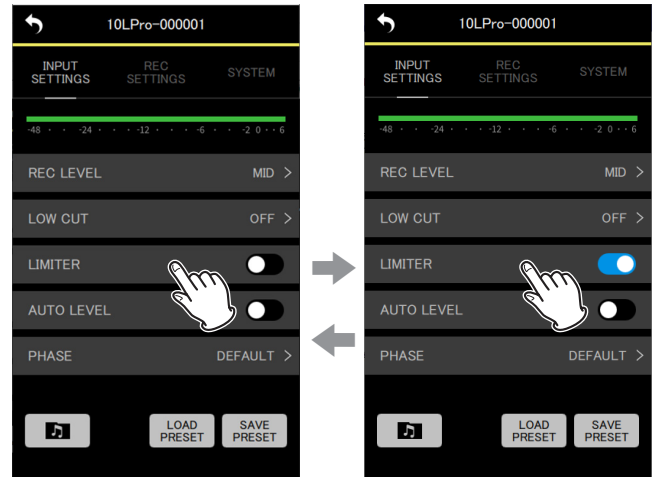

NOTE

- Distortion of sounds may occur when signals that are very loud are input even if the LIMITER function is activated. In such a case, change the REC LEVEL item setting to lower the recording level or increase the distance of the mic from the sound source.
- LIMITER can also be set in the effects settings on individual unit screens (see "Individual device screens (DR-10L Pro)" on page 12).

7. Changing settings for devices

AUTO LEVEL

When the input sound level is too low or too high, this function can automatically increase or decrease the recording level to an appropriate level.

Setting items (default value underlined)
OFF / ON

Tap this to turn it on/off.

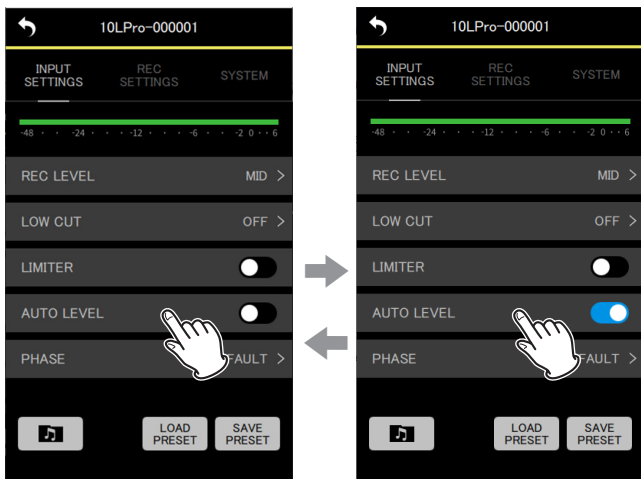

NOTE

If the AUTO LEVEL item is set to ON, it will be reset to OFF when the REC LEVEL setting is changed.

When this happens, "AUTO LVL Cancel" will appear in a pop-up message.

To use the auto level function, after setting the REC LEVEL item, set the AUTO LEVEL item to ON again.

PHASE

Some mics output positive signals and others output negative signals. Set this according to the connected mic type.

Setting items (default value underlined)
DEFAULT / INVERT

DEFAULT: Record as a positive signal when using the included mic and when positive sound pressure is input.

INVERT: Record as a negative signal (signal with phase inverted) when using the included mic and when positive sound pressure is input.

1. Tap the setting menu.

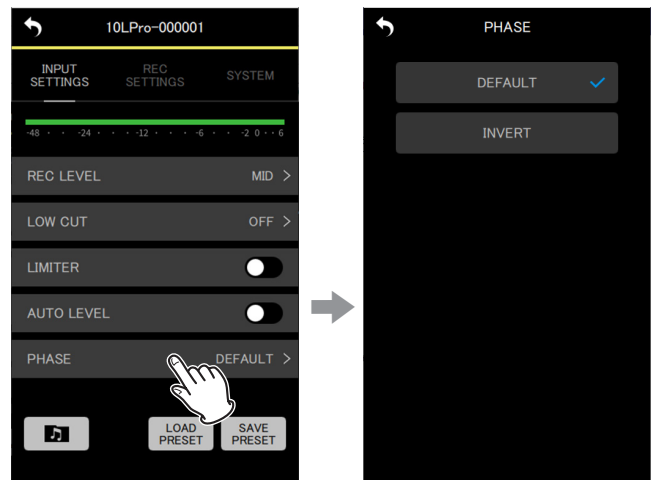

The setting items screen will open.

2. Tap a setting item.

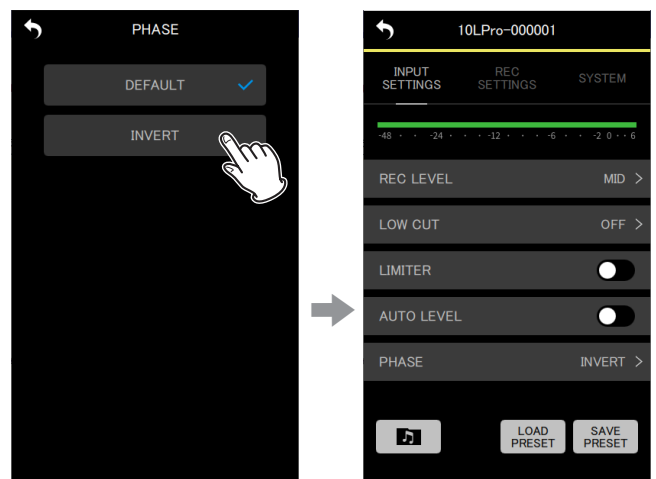

The change will be applied and the INPUT SETTINGS menu screen will reopen.

NOTE

The mic included with the DR-10L Pro is a type that outputs negative signals. The DEFAULT setting records as a positive signal.

REC SETTINGS menu

FILE FORMAT

This sets the recording file format

Setting items (default value underlined)
WAV / MP3HR / MP3LR

WAV: WAV format will be used for recording files.
 MP3HR: 192kbps MP3 format will be used for recording files.
 MP3LR: 128kbps MP3 format will be used for recording files.

1. Tap the setting menu.

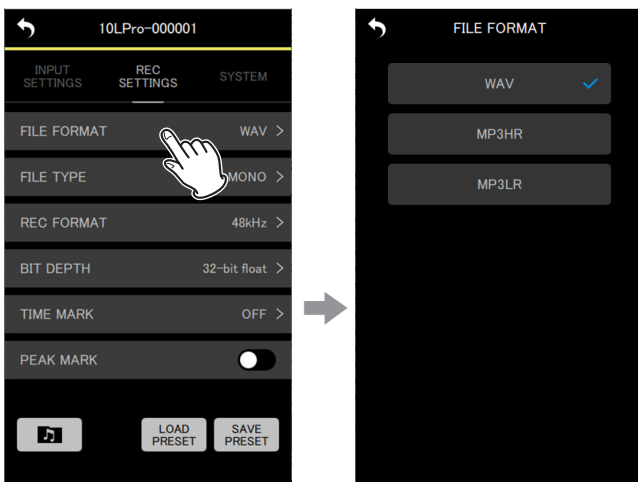

The setting items screen will open.

2. Tap a setting item.

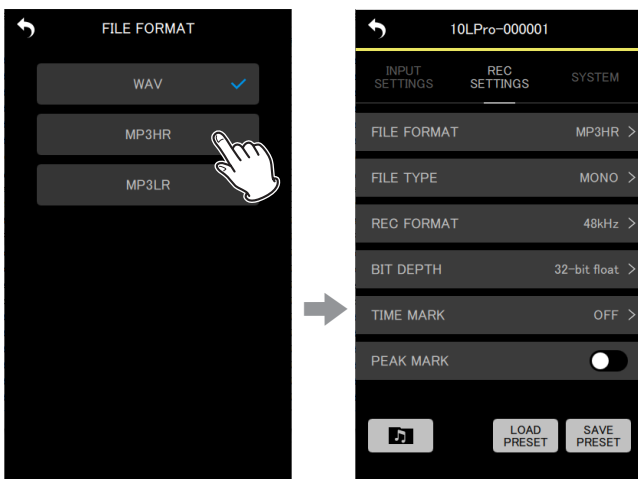

The change will be applied and the REC SETTINGS menu screen will reopen.

NOTE

The 44.1kHz/48kHz sampling frequency and MONO (mono)/ POLY (stereo) recording file type settings will be applied to files recorded in MP3 format. When POLY (stereo), the same data will be recorded on the left and right channels.

FILE TYPE

The type of WAV recording file can be set.

Setting items (default value underlined)
MONO / POLY

MONO: Files will be handled as mono files.

POLY: Files will be handled as stereo files. (The same data will be on left and right channels.)

1. Tap the setting menu.

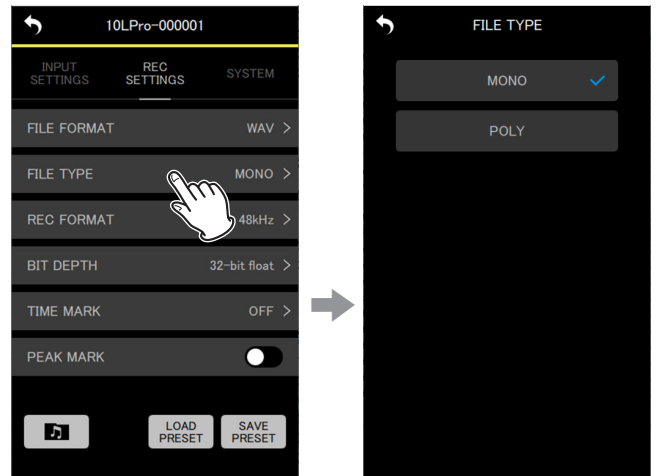

The setting items screen will open.

2. Tap a setting item.

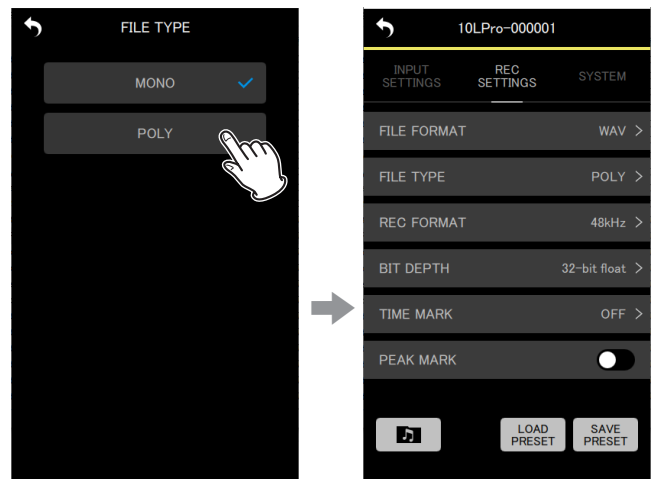

The change will be applied and the REC SETTINGS menu screen will reopen.

7. Changing settings for devices

REC FORMAT

The sampling frequency used for recording can be set.

Setting items (default value underlined>)

44.1 kHz / 48 kHz

1. Tap the setting menu.

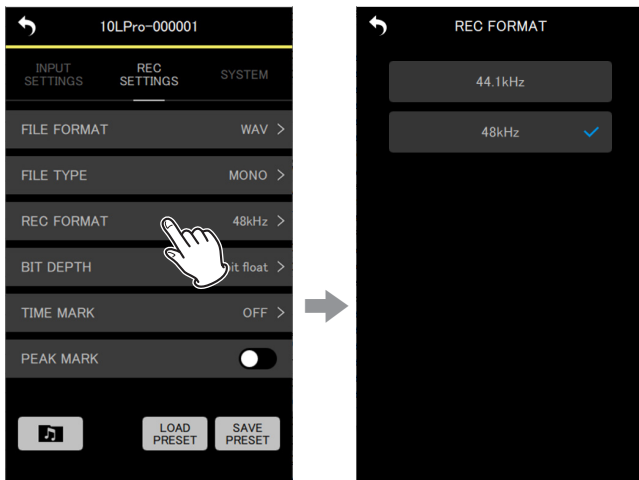

The setting items screen will open.

2. Tap a setting item.

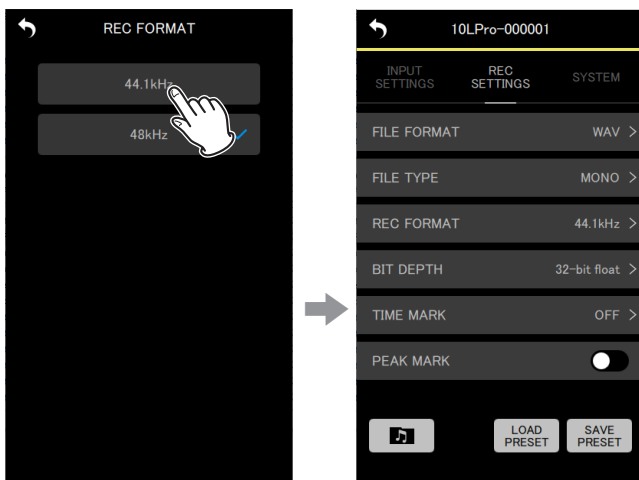

The change will be applied and the REC SETTINGS menu screen will reopen.

BIT DEPTH

The quantization bit depth used when recording can be set.

Setting items (default value underlined>)

16bit / 24bit / 32-bit float

32-bit float

The DR-10L Pro supports 32-bit float recording. Files recorded using 32-bit float have the following advantages when being edited afterward.

- The levels of quiet sounds can be raised without changing their original sound qualities.
- Sounds that seem clipped can be restored to unclipped sounds by lowering their volumes.

CAUTION

Clipping by the analog section will not be changed when volume is lowered.

1. Tap the setting menu.

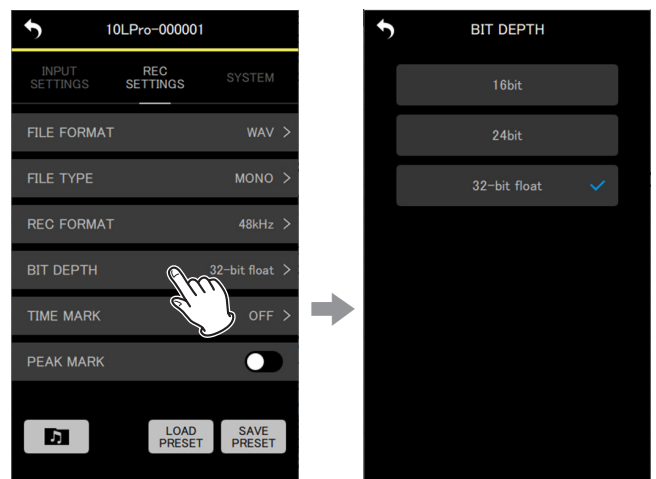

The setting items screen will open.

2. Tap a setting item.

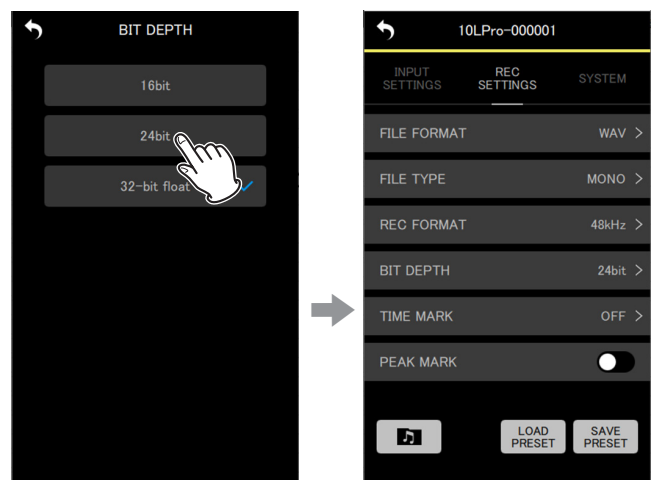

The change will be applied and the REC SETTINGS menu screen will reopen.

TIME MARK

The time that marks are added automatically when a set recording time elapses can be set.

Setting items (default value underlined>)
OFF / 5min / 10min / 15min / 30min / 60min

1. Tap the setting menu.

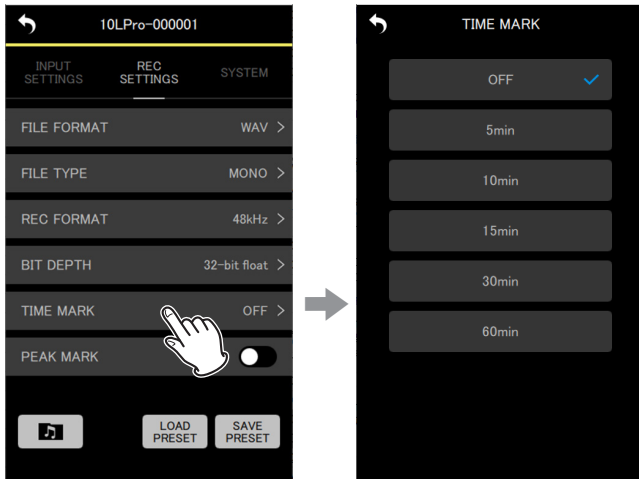

The setting items screen will open.

2. Tap a setting item.

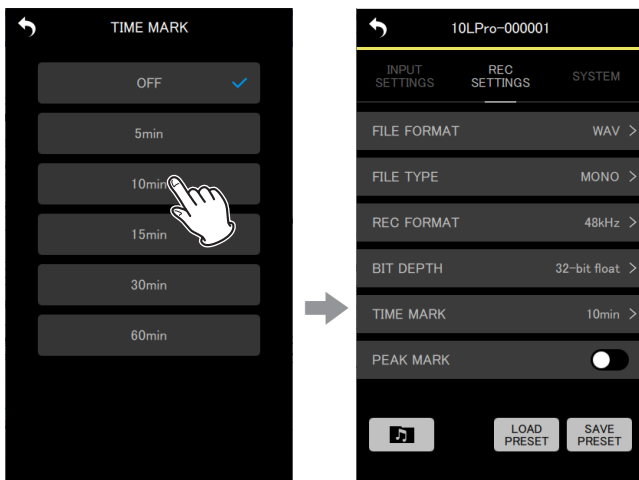

The change will be applied and the REC SETTINGS menu screen will reopen.

PEAK MARK

Marks can be added automatically when input signals exceed the peak level during recording.

This can be used after recording to find parts where the peak level was exceeded.

Setting items (default value underlined)
OFF / ON

Tap this to turn it on/off.

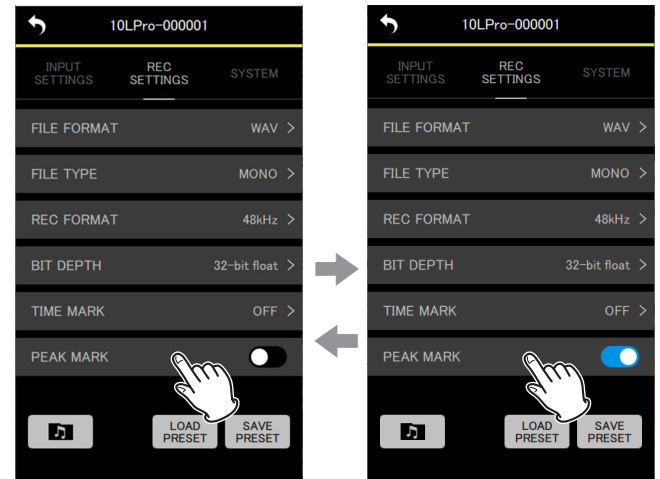

7. Changing settings for devices

SYSTEM settings menu

OUTPUT VOLUME

Use these to adjust the volume output from the headphone jack on the DR-10L Pro.

The volume shows the value set on the unit.

Minimum value: 0

Maximum value: 30

Move the slider left and right to change the setting.

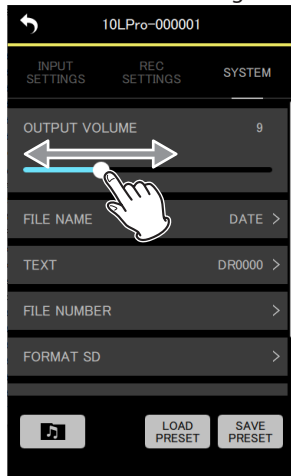

NOTE

The volume is also shown on the display of the DR-10L Pro.

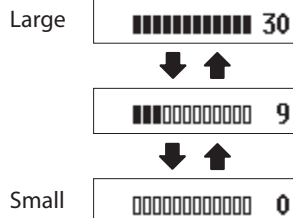

FILE NAME

The format used for file names can be set.

Setting items (default value underlined>)

TEXT / DATE / UNIT NAME

TEXT: The 6 characters set with the TEXT item are added to the file name.

Example: DR0000_0001.wav

DATE: The date is used as the file name.

Example: 110101_0001.wav

UNIT NAME: The device name of the DR-10L Pro unit is added to the file name.

Example: DR-10LPro_0001.wav

NOTE

- The UNIT NAME must be set on the DEVICE SETTINGS Screen. (see "DEVICE SETTINGS Screen" on page 21)
- If the UNIT NAME has not been set, "DR-10LPro" will be used for file names.

TIP

If DATE is selected, the file name will be created using the date and time of the unit's internal clock. Set the clock in advance to enable recording with the correct date and time.

1. Tap the setting menu.



The setting items screen will open.

2. Tap a setting item.

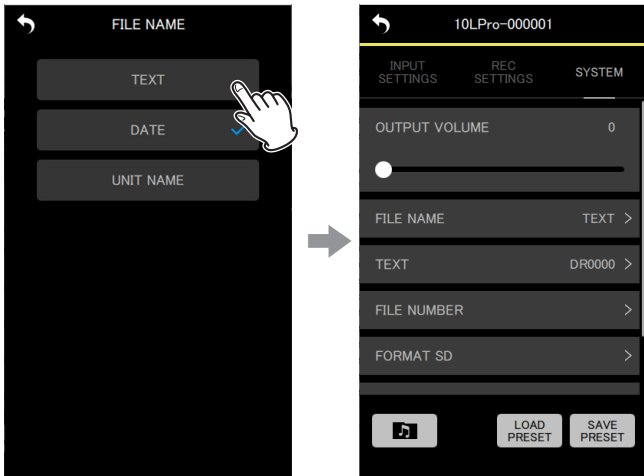

The change will be applied and the SYSTEM settings menu screen will reopen.

7. Changing settings for devices

TEXT

Files can be named using 6 selected characters.

Setting items (default value underlined>
DR0000

NOTE

- To use the set characters for file names, the FILE NAME item must be set to TEXT.
- Using more or less than 6 characters is not possible.

TIP

When using more than one DR-10L Pro unit, you can set the file name in advance to identify which units were used to record files. This can be convenient when editing files.

Examples

	Characters set for TEXT	File name
1st unit	DR0001	[DR0001_0001.wav]
2nd unit	DR0002	[DR0002_0001.wav]
3rd unit	DR0003	[DR0003_0001.wav]
:	:	:
10th unit	DR0010	[DR0010_0001.wav]

1. Tap the setting menu.

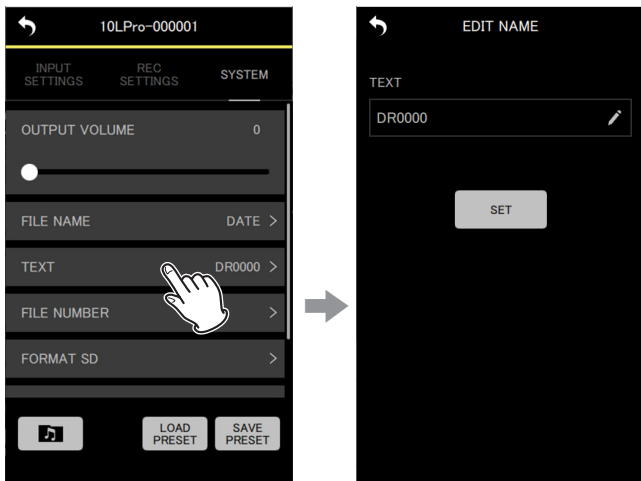

This opens the EDIT NAME screen.

2. Use a keyboard to input characters in the input field.

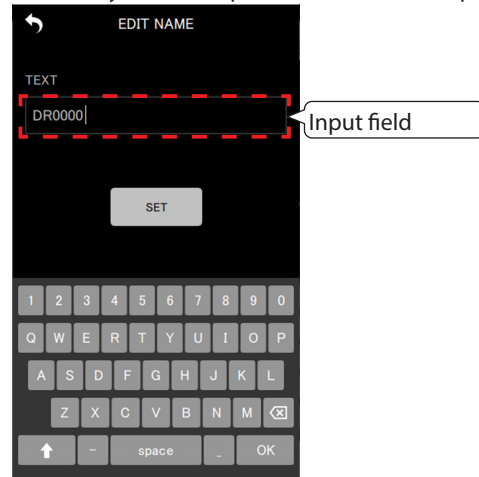

3. Tap the  button.

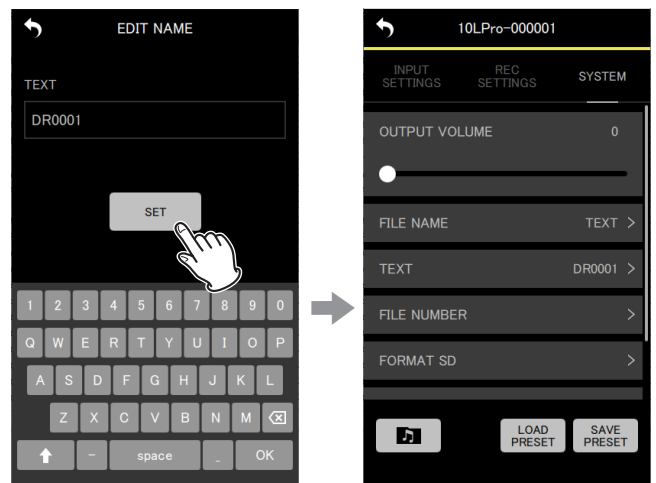

The change will be applied and the SYSTEM settings menu screen will reopen.

FILE NUMBER

The file number that will be used the next time a file is created can be set.

Settings

Minimum value: 0000

Maximum value: 9999

The set file number will be enabled from the next recording.

NOTE

- If a file with the same name and number already exists at the time of recording, “[---]” will be added after the file number. (--- is a three-digit number from 001 to 999.)
- If the METADATA function is on, the setting item will be grayed out and the setting content will have no effect.

3. Tap the  button.

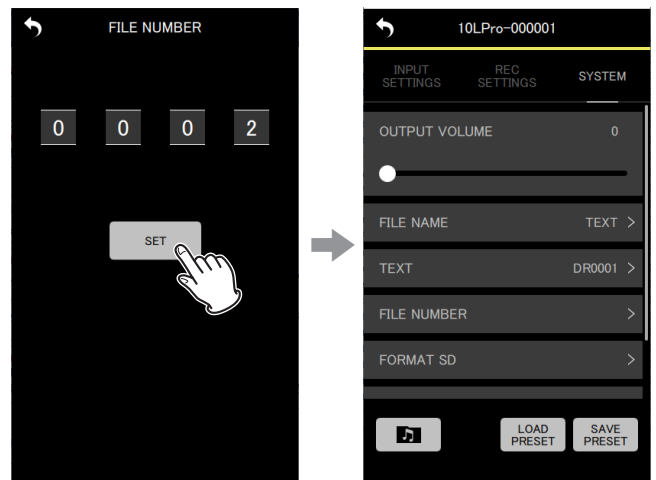

The change will be applied and the SYSTEM settings menu screen will reopen.

1. Tap the setting menu.



The setting items screen will open.

2. Move the numbers up and down to change them.

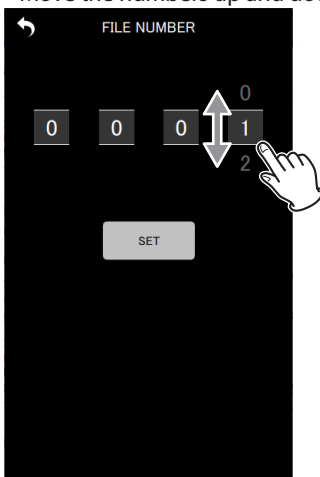

7. Changing settings for devices

FORMAT SD

This unit can format SD cards.

Setting items (default value underlined>)

QUICK / FULL ERASE

QUICK: Execute quick formatting.

FULL ERASE: Erase and format.

CAUTION

- Formatting will erase all data on a microSD card. Back up to a computer, for example before formatting a card.
- When formatting a card, the unit should be on USB bus power supplied from a connected computer or batteries with sufficient remaining power.

NOTE

- Using the ERASE format option might improve writing performance that has decreased due to repeated use.
- Erase-formatting checks for memory errors as it formats, so it takes more time compared to QUICK formatting.

1. Tap the setting menu.

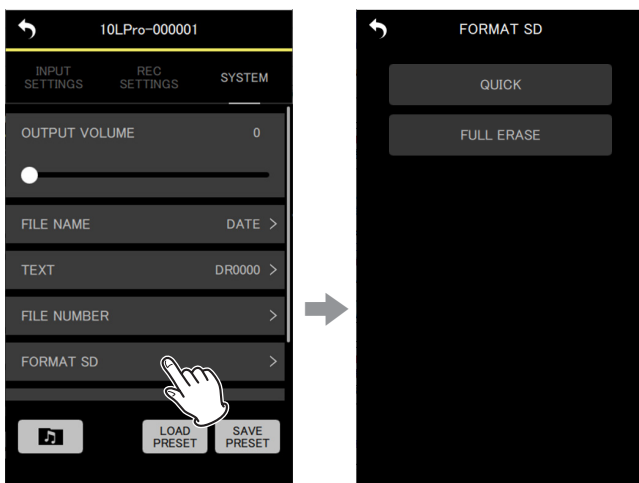

The setting items screen will open.

2. Tap the formatting method.

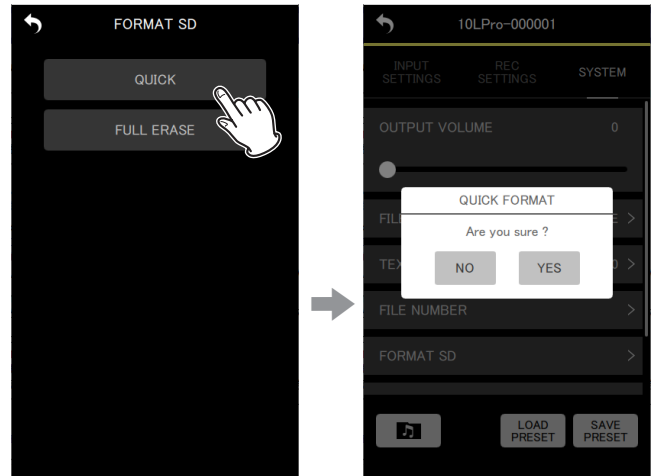

Pop-up when QUICK selected

A confirmation pop-up message will appear.

3. Tap "YES".



 will appear, showing that the app is working.

This will start the formatting process on the DR-10L Pro. While formatting, the state of progress will be shown on the DR-10L Pro display.

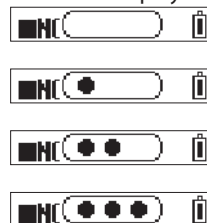

NOTE

No operation is necessary on the hardware unit.

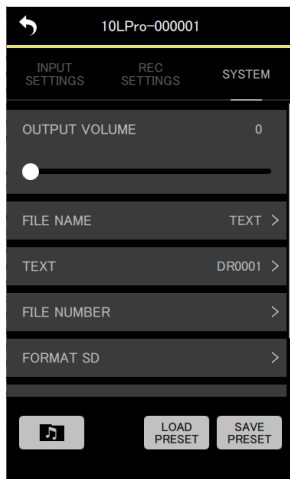

When formatting is complete, the SYSTEM settings menu screen will reopen.

7. Changing settings for devices

SYSTEM INITIALIZE

The unit can be reset to its factory default settings.

Setting items (default value underlined>)

NO / YES

NO: Return to the Menu Screen.

YES: Initialize the settings.

1. Tap the setting menu.

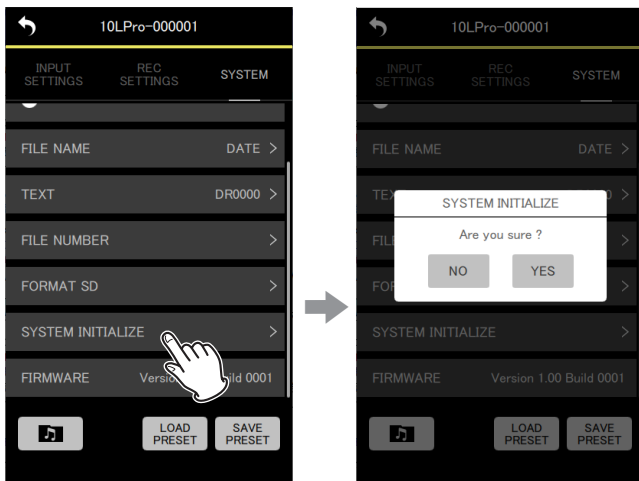

A confirmation pop-up message will appear.

2. Tap "YES".

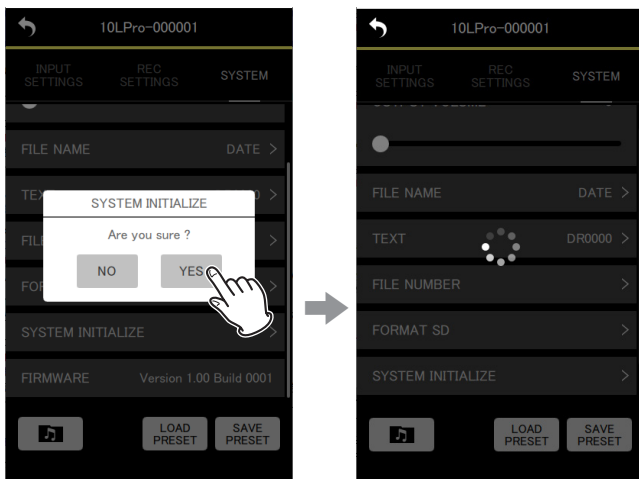

 will appear, showing that the app is working.

This will start the initialization process on the DR-10L Pro. While initializing, the state of progress will be shown on the DR-10L Pro display.

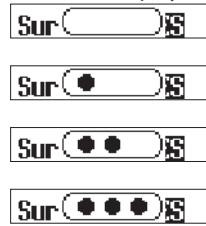

After initialization completes, the Home Screen will appear.

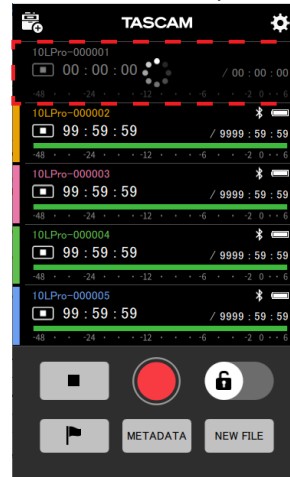

A unit that has been initialized will be shown as disconnected.

NOTE

After initialization, the remote control function on the DR-10L Pro unit will be turned off (default value).

To reconnect, turn on the remote control function and connect using SEARCH DEVICES. (see "Enabling the remote control function of a DR-10L Pro" on page 5) (see "Connecting devices" on page 7)

FIRMWARE

This shows the DR-10L Pro unit firmware version.

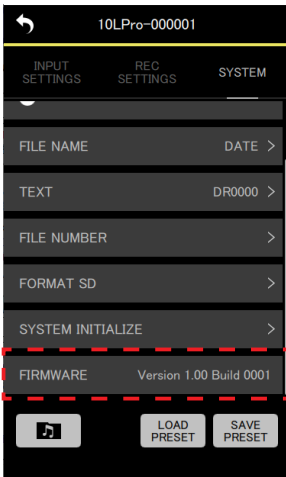



7. Changing settings for devices

7-3. SETTINGS Screen (FR-AV2)

On the SETTINGS Screen, all MENU settings of the device being shown can be changed.

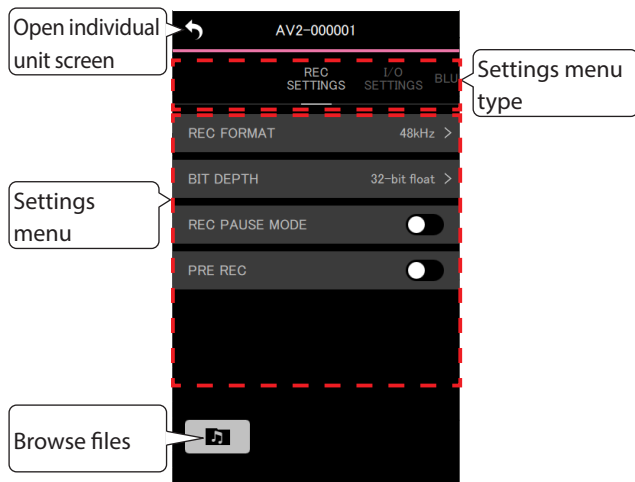
See the FR-AV2 Owner's Manual for details about setting items and setting procedures.



Settings menu type	Tap a type of settings menu to show the corresponding settings. The title of the menu being shown will have white characters and a white underline.
Settings menu	Setting items are shown for the open settings menu type.
 button	This opens the BROWSE Screen. (see "BROWSE Screen" on page 50) Operations can be conducted for the files on the unit being shown.

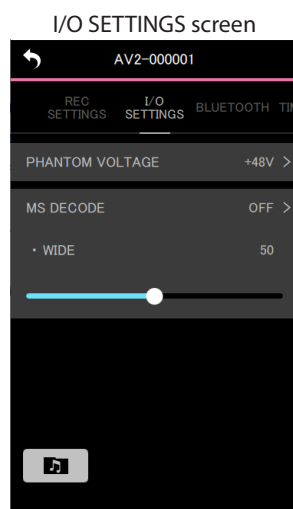
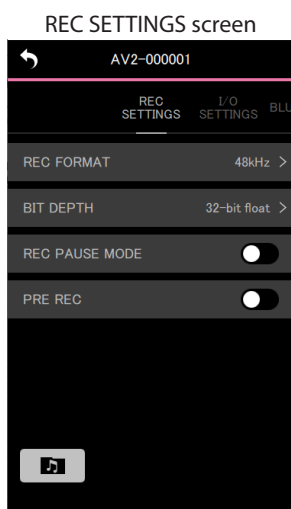
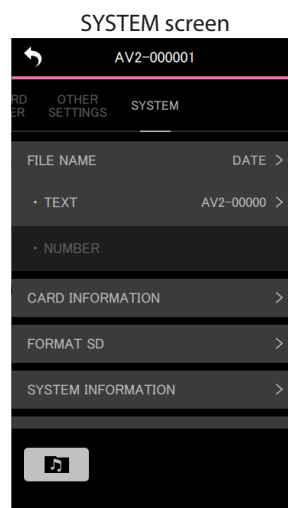
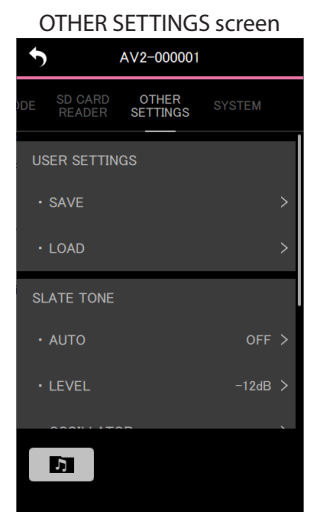
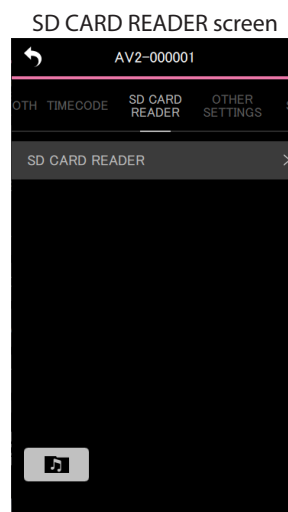
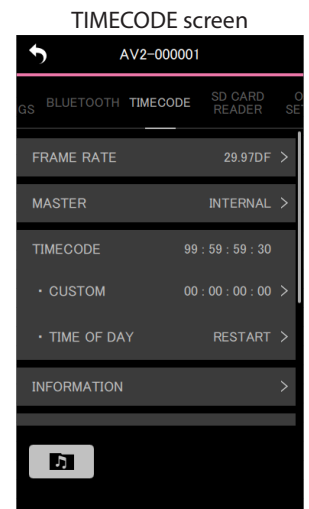
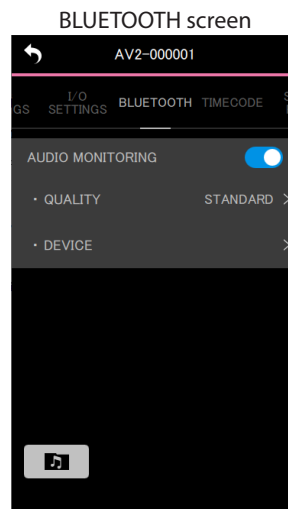

BLUETOOTH settings menu

Use of the AUDIO MONITORING setting in the app

This app cannot be used to connect to wireless audio monitoring devices that have not already been paired. Pairing with wireless audio monitoring devices using the FR-AV2 is necessary in advance. Moreover, wireless audio monitoring devices cannot be selected and connected freely. Only the last connected wireless audio monitoring device can be connected again.

To connect to different wireless audio monitoring devices, conduct the procedures on the FR-AV2.

See the FR-AV2 Owner's Manual for details about procedures for pairing and connecting with an FR-AV2.

CAUTION

Before connecting, lower the volume of the wireless audio monitoring device to its minimum.

Failure to do so might cause sudden loud noises, which could harm hearing or result in other trouble.

TIP

By turning on/off the wireless audio monitoring functions for an FR-AV2 on the APP SETTINGS – AUDIO MONITORING – MONITOR SELECT screen, a connected wireless audio monitoring device can be reconnected to a different FR-AV2. See "Connecting wireless audio monitoring devices to different FR-AV2 units" on page 57 for details.

8. Preset functions

This app can be used to save and load various DR-10L Pro unit settings as preset data.

A maximum of 5 presets can be saved.

NOTE

Presets cannot be recalled if a DR-10L Pro is not connected. In this case, presets can only be edited and saved.

8-1. Editing presets

1. Tap "EDIT PRESETS" on the opening screen.

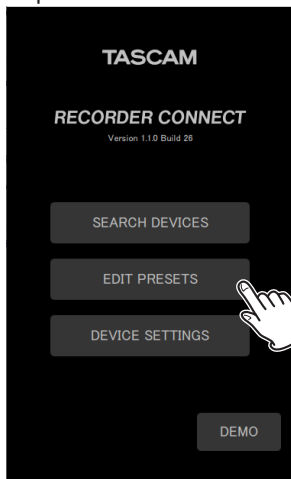

This opens the PRESET LIBRARY Screen.

2. Tap the  icon for the preset you want to edit.



This will open the Preset Settings Screen.

Preset Settings Screen

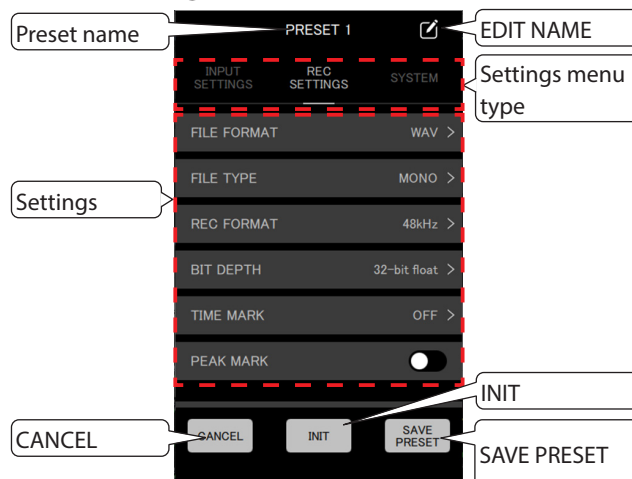

Tap the  button to return to the PRESET LIBRARY Screen without saving the settings.

NOTE

The Preset Settings Screen can also be opened with DEVICE PRESET on the APP SETTINGS Screen. (APP SETTINGS > DEVICE PRESET >  icon for preset to be edited)

Editing presets

1. Tap a setting menu followed by a setting item to change it.

NOTE

- See “SETTINGS Screen (DR-10L Pro)” on page 22 for details about setting menus and setting items.
- Items that cannot be saved with presets appear gray.

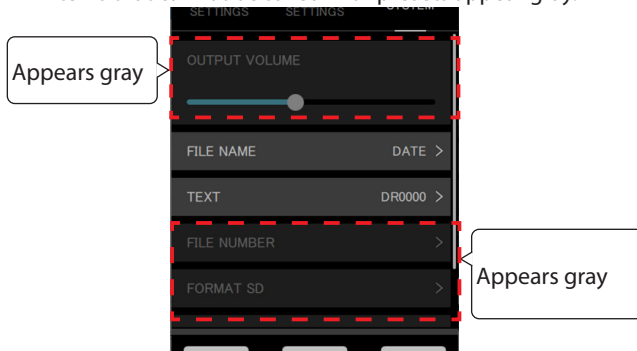

2. When finished editing, tap the  button.

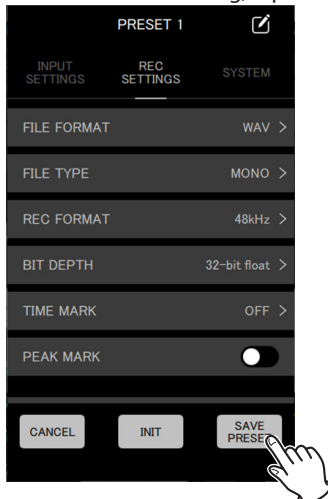

A confirmation pop-up message will appear.

3. Tap “YES”.



This will save the preset and reopen the PRESET LIBRARY Screen.

8. Preset functions

Changing preset names

1. Tap the  icon to the right of the preset name on the Preset Settings Screen.

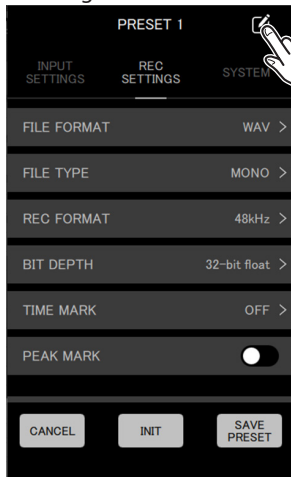

This opens the EDIT NAME screen.

2. Use the keyboard to input the preset name in the input field.

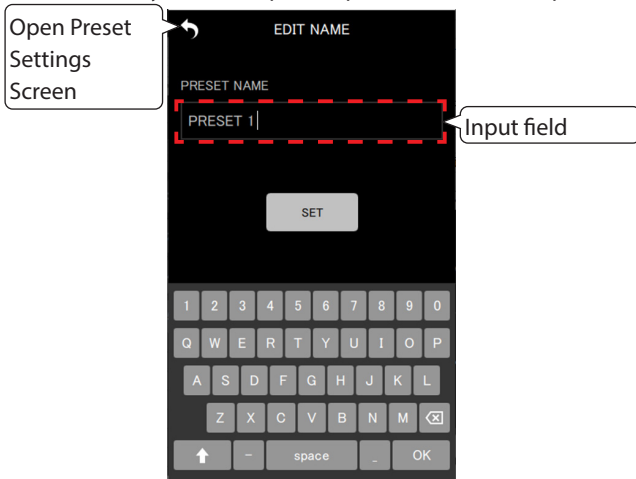

NOTE

Preset names can be up to 15 characters. The default value will be used if it is saved without any characters.

3. Tap the  button.



This will save the preset name change and reopen the Preset Settings Screen.

Initializing presets

1. Tap the **INIT** button on the Preset Settings Screen.

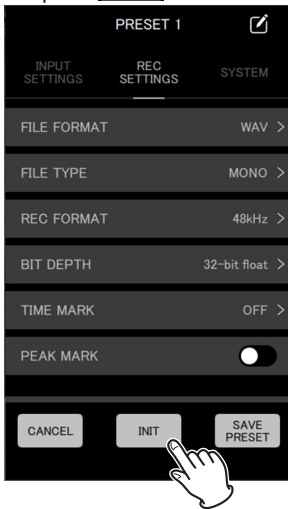

A confirmation pop-up message will appear.

2. Tap "YES".

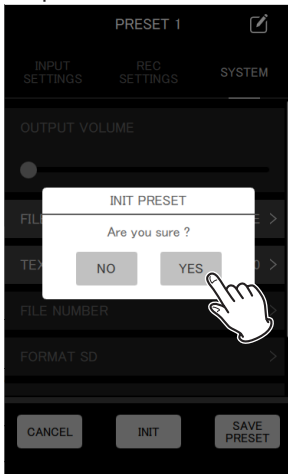

This will set the preset to its initial values and reopen the Preset Settings Screen.

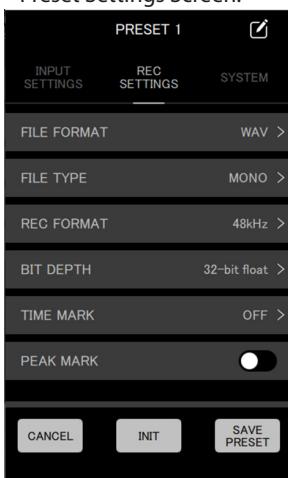

NOTE

Default settings can also be saved to a preset.

8. Preset functions

8-2. Loading presets (DR-10L Pro only)

Settings saved by editing presets can be loaded to change the settings of DR-10L Pro units.

Different procedures are used for loading presets to multiple DR-10L Pro units and for loading them to individual units.

Loading presets to multiple DR-10L Pro units

Use the DEVICE PRESET item on the APP SETTINGS Screen to load presets to multiple DR-10L Pro units.

1. Tap the  icon at the top right of the Home Screen.

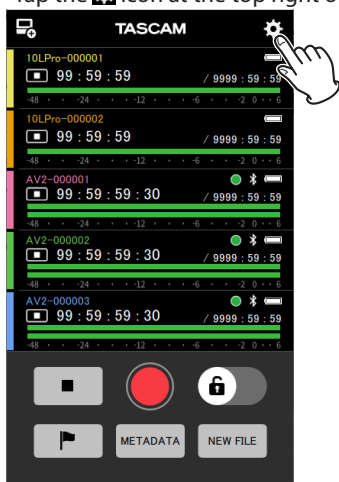

This opens the APP SETTINGS Screen.

2. Tap DEVICE PRESET.

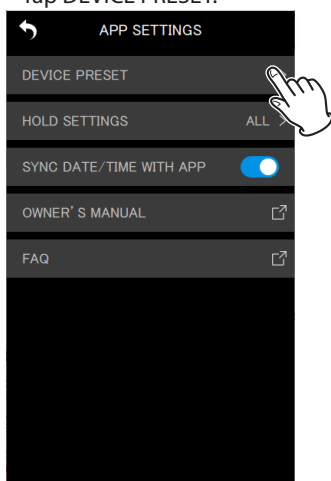

This opens the PRESET LIBRARY Screen.

3. Tap the  icon for the preset you want to load.



This opens the LOAD PRESET screen.

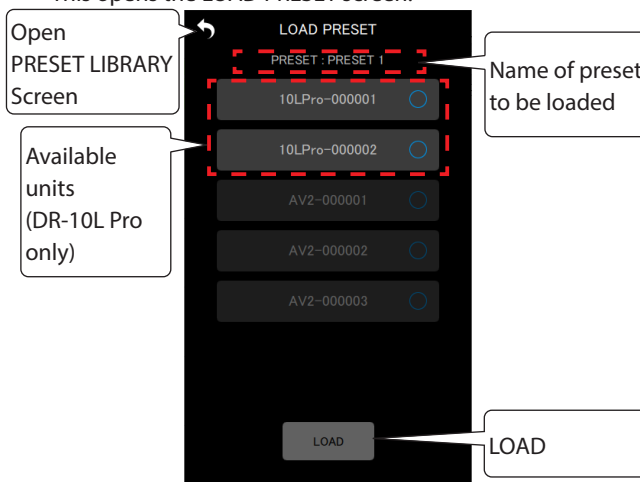

4. Tap DR-10L Pro units to select them for applying the loaded preset.

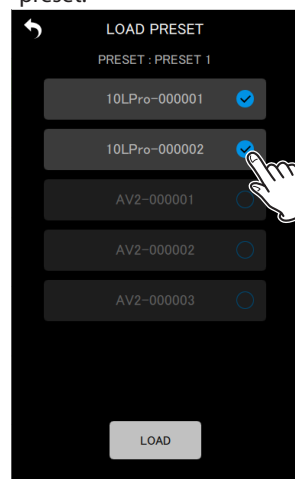

NOTE

- The same preset will be applied to all DR-10L Pro units selected here.
- If no DR-10L Pro units are connected or they are recording/playing, all devices will appear gray and cannot be selected.

5. Tap the  button.

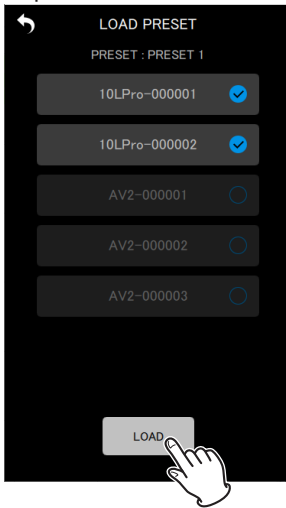

A confirmation pop-up message will appear.

6. Tap "YES".

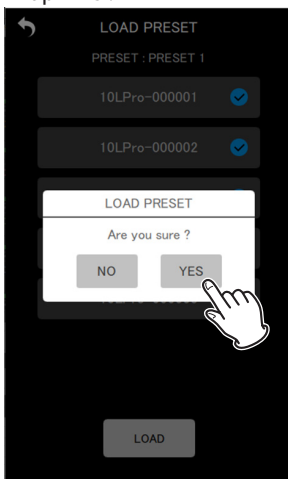

This will apply the settings of the loaded preset to all selected DR-10L Pro units and reopen the PRESET LIBRARY Screen.



8. Preset functions

Loading presets to individual DR-10L Pro units

Use the LOAD PRESET item on the SETTINGS Screen of an individual DR-10L Pro to load a preset to it.

1. Tap the  icon at the top right of the individual unit screen.

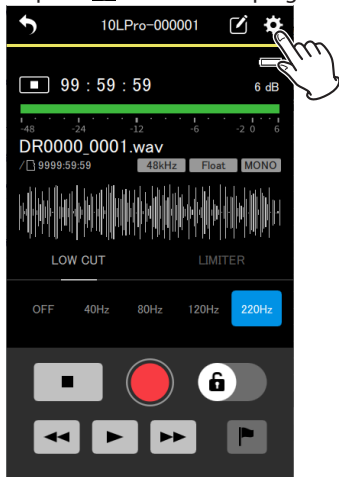

This opens the SETTINGS Screen.

2. Tap the  button.

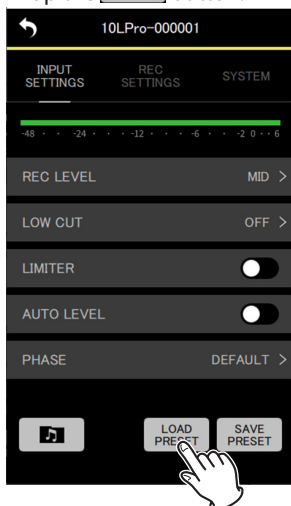

This opens the PRESET LIBRARY Screen.

3. Tap the  icon for the preset you want to load.

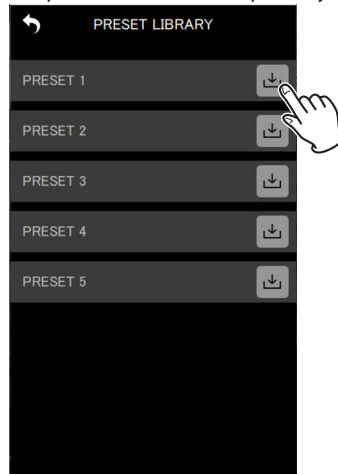

A confirmation pop-up message will appear.

4. Tap "YES".

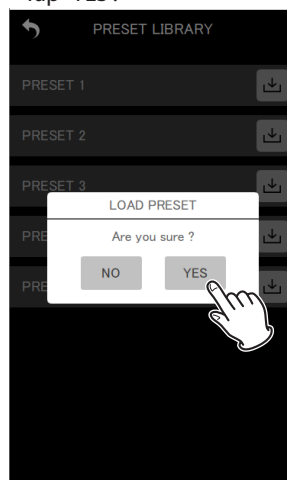

This will apply the settings of the loaded preset and reopen the SETTINGS Screen.

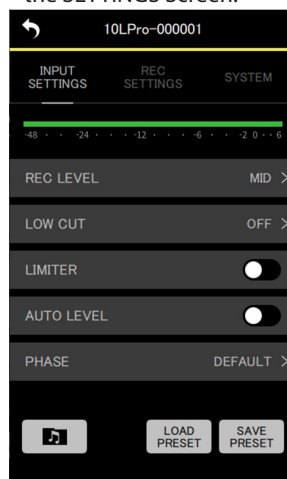

9. Device settings functions

By using this app to set the BLUETOOTH ID and UNIT NAME as device data in advance, the UNIT NAME can be shown as the device name.
Devices that have device data set will always be shown in the AVAILABLE list.

9-1. Setting device data

Set device data on the DEVICE SETTINGS screen.

1. Tap "DEVICE SETTINGS" on the opening screen.

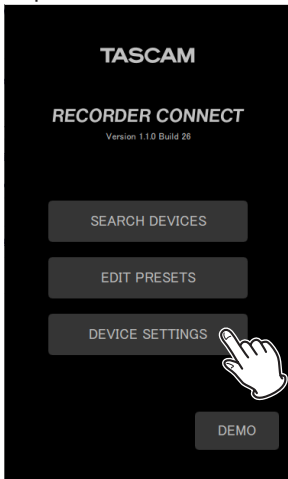

This opens the DEVICE SETTINGS Screen.

2. Tap the  icon at the top right of the DEVICE SETTINGS Screen.



This will open a screen for adding device data settings.

NOTE

Device data for units that have been found using SEARCH DEVICES will already be set and they will be shown on the DEVICE SETTINGS Screen.

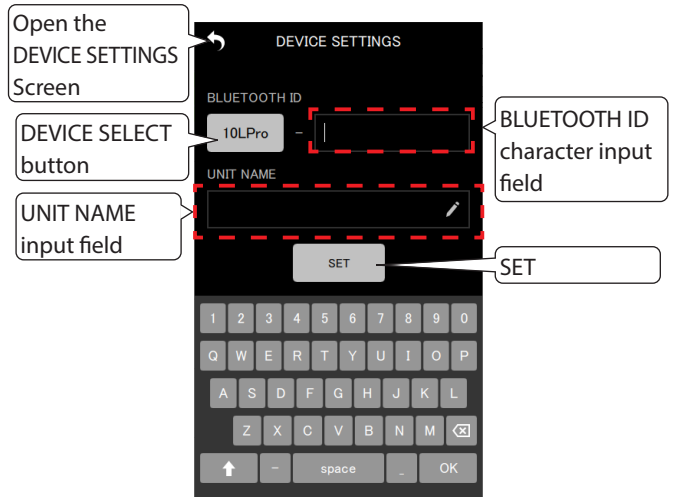

DEVICE SELECT button	Tap this to open the DEVICE SELECT screen. Devices can be selected on the DEVICE SELECT screen. The default value is DR-10L Pro.
BLUETOOTH ID character input field	The default value is empty. The maximum number of characters is 7. Settings cannot be added if this field is left empty.
UNIT NAME input field	The default value is empty. The maximum number of characters is 11.
 button	This saves the settings and reopens the DEVICE SETTINGS Screen.

3. Tap the DEVICE SELECT button.
This opens the DEVICE SELECT screen.

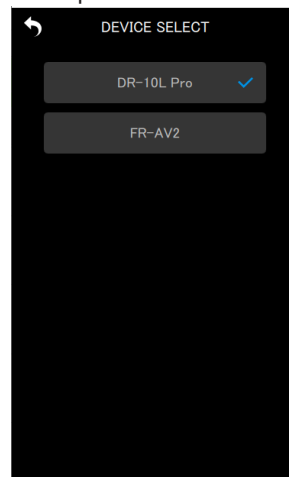

9. Device settings functions

4. Tap the device to be set.

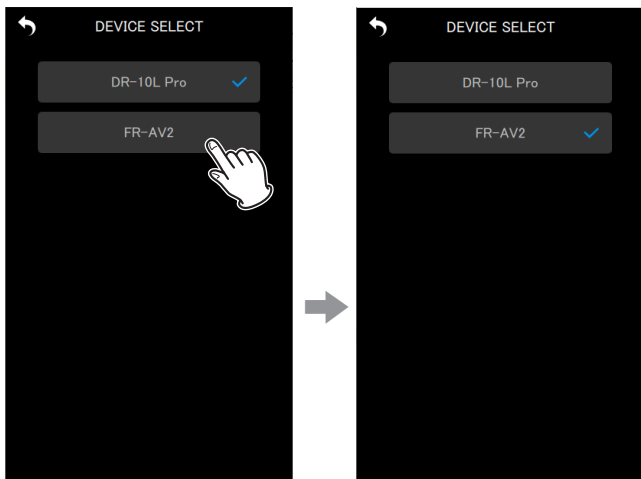

5. Tap the return icon at the top left of the screen.

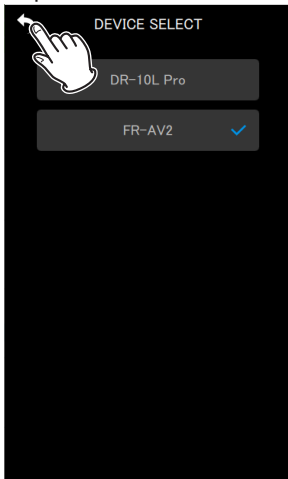

6. Tap the BLUETOOTH ID character input field and input characters.

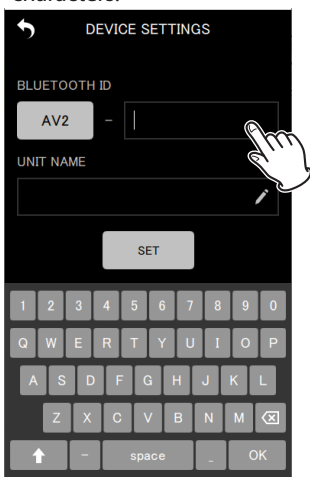

7. Tap the UNIT NAME input field.

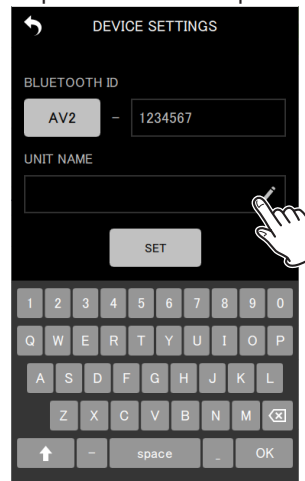

NOTE

- If nothing is input for the UNIT NAME, the BLUETOOTH ID will be shown as the device name.
- BLUETOOTH IDs can be checked with the following items on the Menu Screens of the devices.

DR-10L Pro	26: BT ID item on the recorder Menu Screen
FR-AV2	BLUETOOTH - BLUETOOTH ID item on the recorder Menu Screen

8. Tap the  button.

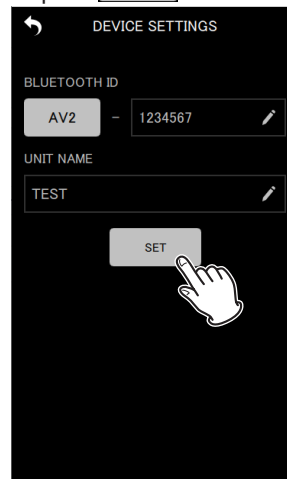

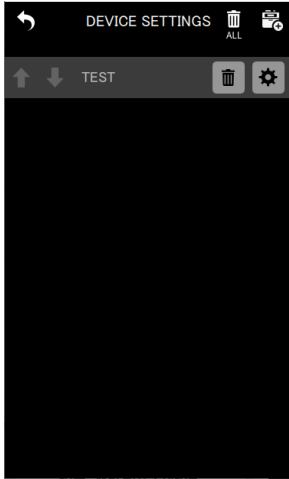

This reopens the DEVICE SETTINGS Screen.

The set device data will be shown.



9. Repeat steps 2 – 4 as necessary to make settings.

NOTE

- The  and  icons can be used to switch the display order.
- Device data can be set for up to 99 units.
- New devices cannot be found if device data for 99 units has already been added. Device data can be removed from the DEVICE SETTINGS Screen to enable finding new devices. See “Removing device data” on page 48 for how to remove devices.

9-2. Removing device data

Registered device data can be removed.

Device data can be removed for all devices or for individual devices using different methods.

Removing device data for all devices

1. Tap "DEVICE SETTINGS" on the opening screen.

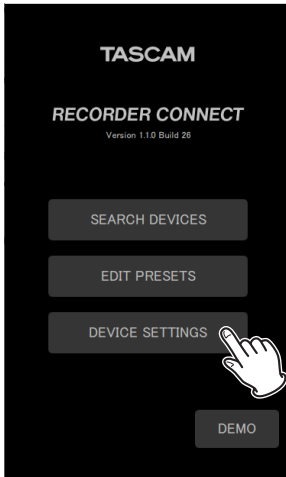

This opens the DEVICE SETTINGS Screen.

2. Tap the  icon at the top right of the DEVICE SETTINGS Screen.



A confirmation pop-up message will appear.

3. Tap "YES".



This will remove device data for all registered devices.



Removing data for individual devices

1. Tap "DEVICE SETTINGS" on the opening screen.

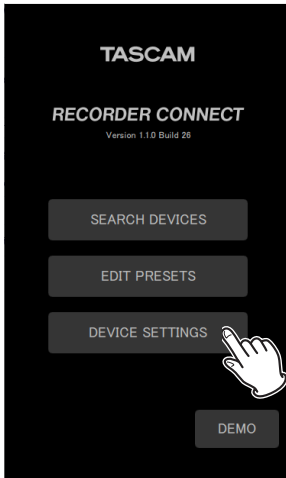

This opens the DEVICE SETTINGS Screen.

2. Tap the  icon for the device data you want to remove.



A confirmation pop-up message will appear.

3. Tap "YES".



The selected device data will be removed.



4. Repeat steps 2 – 3 as necessary to remove more data.

10. File operations



The app can be used to conduct operations on files in individual units.

Work with files on the BROWSE Screen.

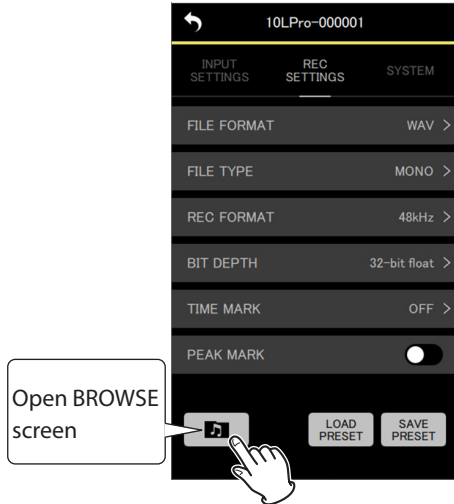
Tap the  button on the SETTINGS Screen for the individual device with the file desired for use to open the BROWSE Screen. (see "SETTINGS Screen (DR-10L Pro)" on page 22) (see "SETTINGS Screen (FR-AV2)" on page 36)



Example: DR-10L Pro

Currently selected file	The currently selected file is shown with a blue background.
Audio file indication	Audio files are shown with  icons.
Protected icon	Protected files are shown with  icons.
File name	This shows the file name.
File size	This shows the file size.
File time	This shows the file playback time.

10-2. Selecting files

Tap the file you want to select.

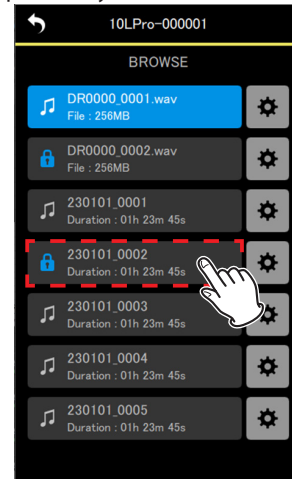

The individual unit screen will reopen with the selected file shown.

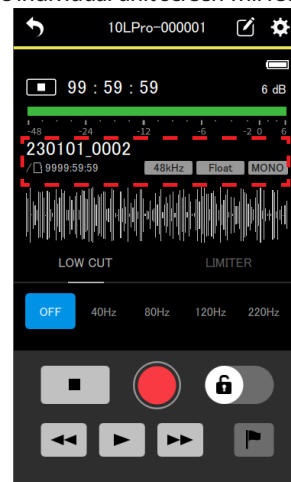

10-1. BROWSE Screen

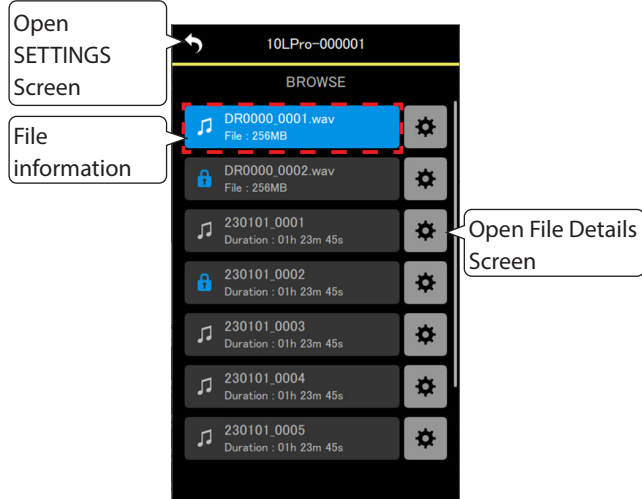

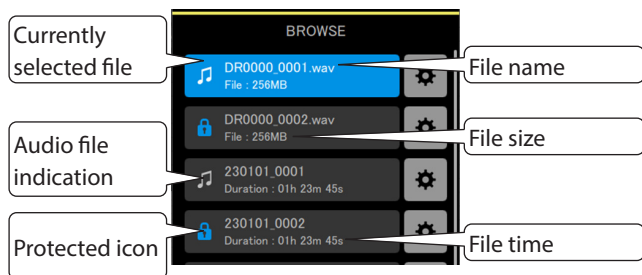

File information



10-3. Playing files quickly (FR-AV2 only)

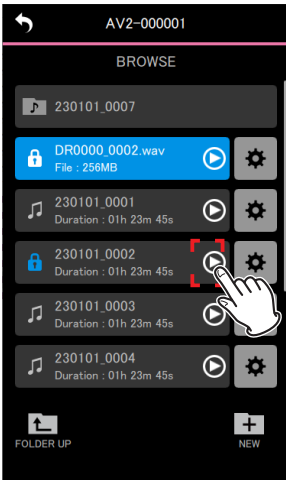

Files can be quickly played from the FR-AV2 BROWSE Screen. Tap the  button for the file to be played.

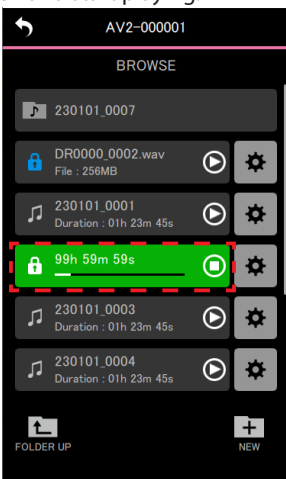

After the  button for a file is tapped, it will be highlighted green and start playing.



Playback of the current file can be stopped with any of the following operations.

- Tap the  button.
- Tap the  button for another file.
- Open a different screen.

10-4. Showing file details

Tap the  icon to the right of the file for which you want to see detailed information.

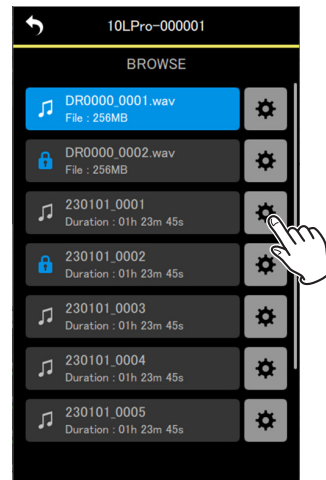

This will open a File Details Screen.

File Details Screen

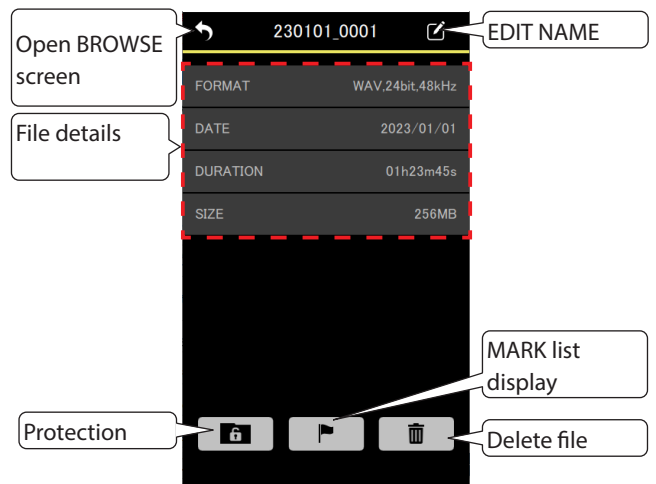

EDIT NAME	The names of recording files saved on the DR-10L Pro can be changed. Files that cannot be changed will appear gray.
File details	This shows the FORMAT, DATE, DURATION (recorded time) and SIZE.
Protection	This turns protection on/off for the selected file.
MARK list display	This shows a list of marks in the selected file.
Delete file	This deletes the selected file.

10-5. Changing file names

1. Tap the  icon to the right of the file name to open the File Details Screen.

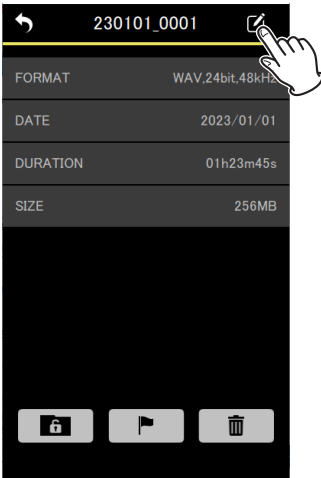

This opens the EDIT NAME screen.

NOTE

The  icons for files with names that cannot be changed will appear gray.

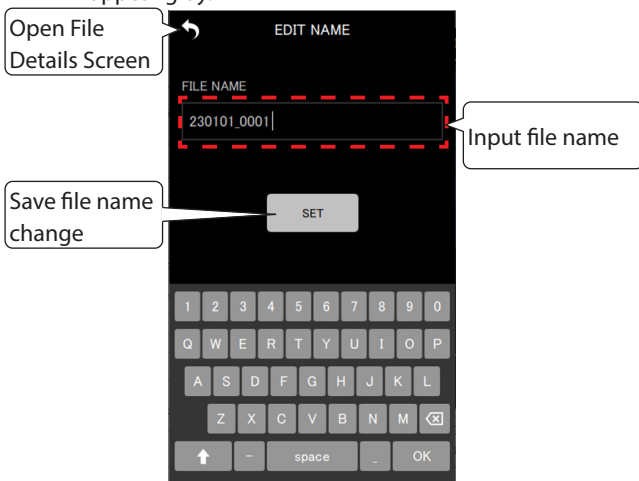

2. Input the file name, and tap the  button. The File Details Screen will reopen.

10-6. Setting file protection

Protection can be set for files. When protection for a file is on, that file cannot be deleted or edited.

1. Tap the  icon on the bottom left of the File Details Screen.

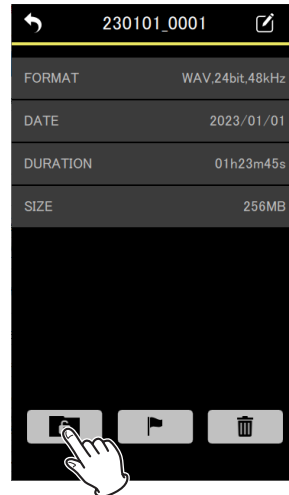

NOTE

- The  button will appear blue for files that have protection on.

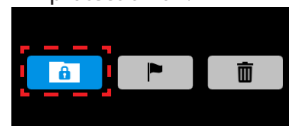

- This operation will turn off protection for files that have it on.

A confirmation pop-up message will appear.

2. Tap "YES".

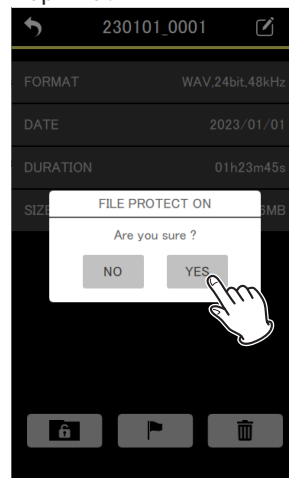

This will change the protection setting.

NOTE

For files that have protection on, a pop-up message appears confirming turning protection off.

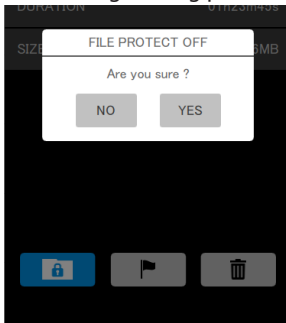

10-7. Deleting files

1. Tap the  icon on the bottom right of the File Details Screen.

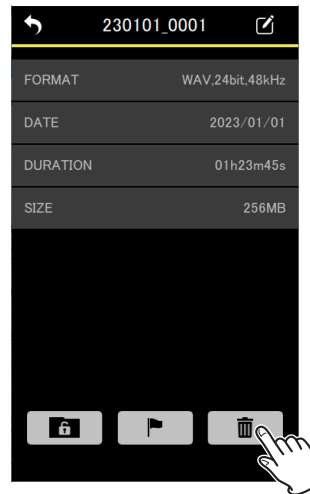

A confirmation pop-up message will appear.

2. Tap "YES".

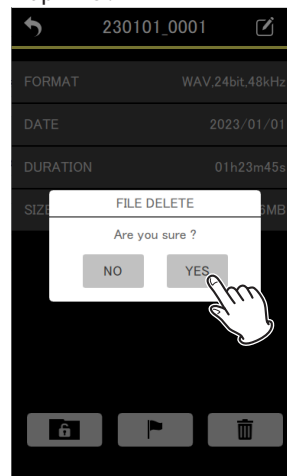

This will delete the file.

10. File operations

10-8. Working with folders (FR-AV2)

Folders can also be used on the FR-AV2 BROWSE Screen.

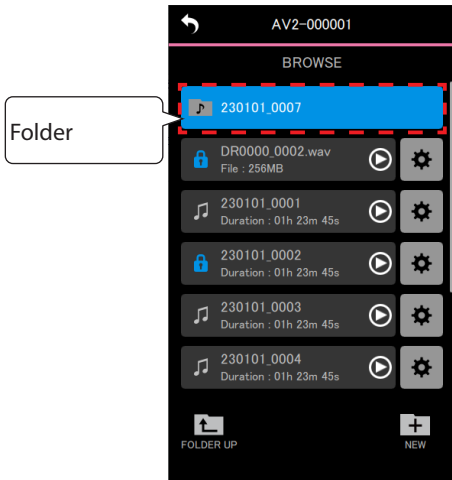

Tap the folder to work with to open a menu screen for folder operation.

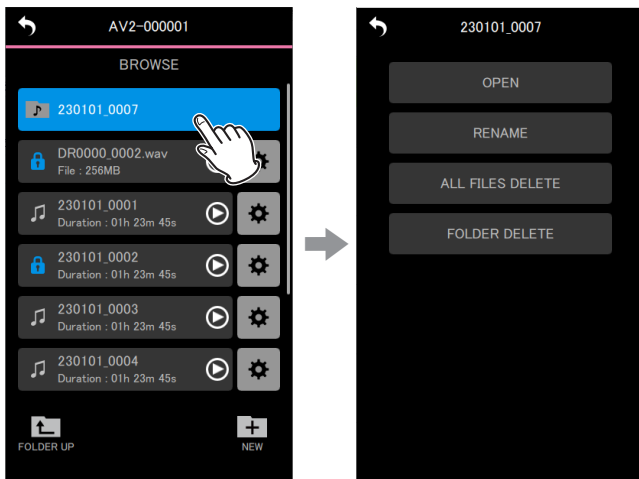

OPEN	This will show the files inside the folder being used.
RENAME	Use this to rename the folder being used. Tap this to open the EDIT NAME screen.
ALL FILES DELETE	Use this to delete all files inside the folder being used. Tapping this will open a confirmation pop-up message.
FOLDER DELETE	Use this to delete the folder being used. Tapping this will open a confirmation pop-up message.

Showing files inside a folder

Tap OPEN on the menu screen for folder operations.

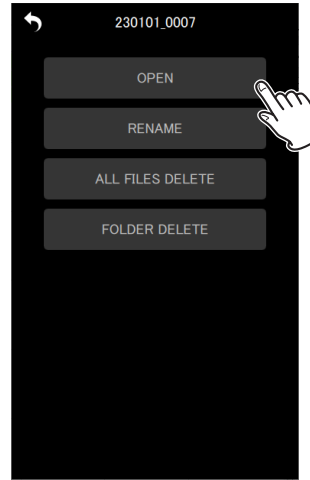

The files inside the folder will be shown.

Changing folder names

1. Tap RENAME on the menu screen for folder operations.

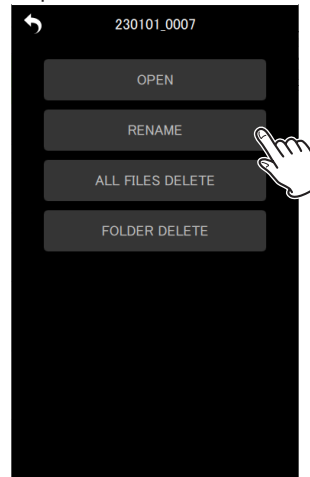

This opens the EDIT NAME screen.

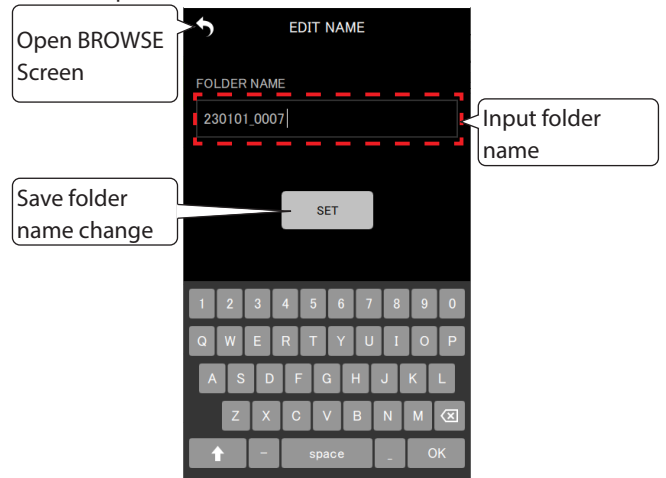

2. Input the folder name and tap the  button. After the folder name has been changed, the BROWSE screen will reopen.

Deleting all files in a folder

1. Tap ALL FILES DELETE on the menu screen for folder operations.

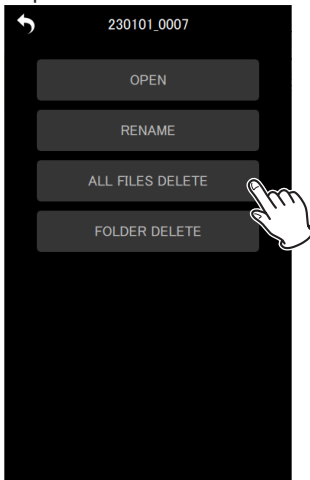

A confirmation pop-up message will appear.

2. Tap "YES".

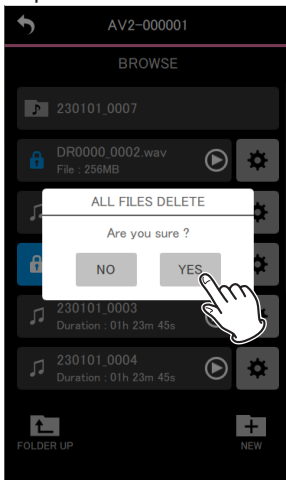

After all files inside the folder being used have been deleted, the BROWSE Screen will reopen.

Deleting folders

1. Tap FOLDER DELETE on the menu screen for folder operations.

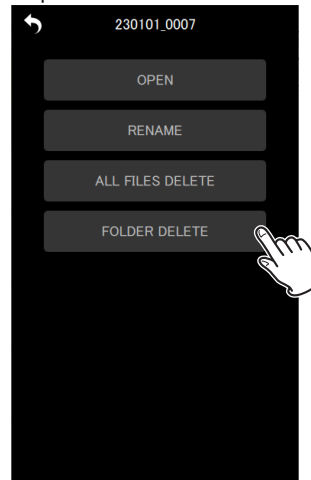

A confirmation pop-up message will appear.

2. Tap "YES".

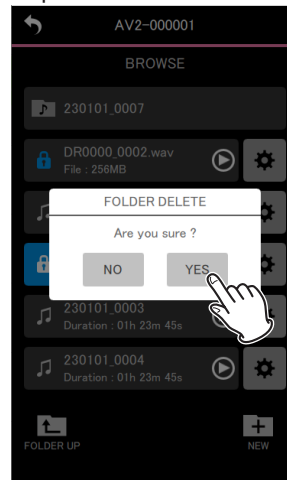

After the folder being used has been deleted, the BROWSE Screen will reopen.

11. Other useful functions

11-1. Setting the HOLD function

By setting the HOLD function, misoperation when recording can be prevented.

The following behaviors can be set using the HOLD SETTINGS item on the APP SETTINGS Screen.

ALL	All operations other than disabling the HOLD function are disabled. (default)
TRANSPORT ONLY	Operation is disabled for the record, stop, play, search forward and search backward buttons.

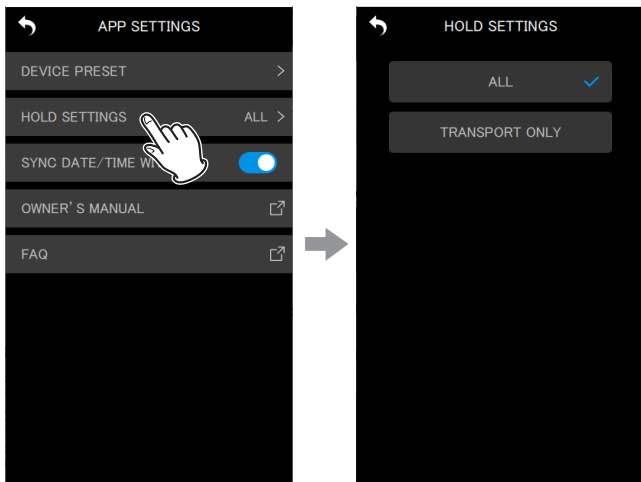

11-2. Synchronizing the time

Time data from the device with the app can be applied to the recorder by turning on the SYNC DATE/TIME WITH APP setting on the APP SETTINGS Screen. (This is off by default.)

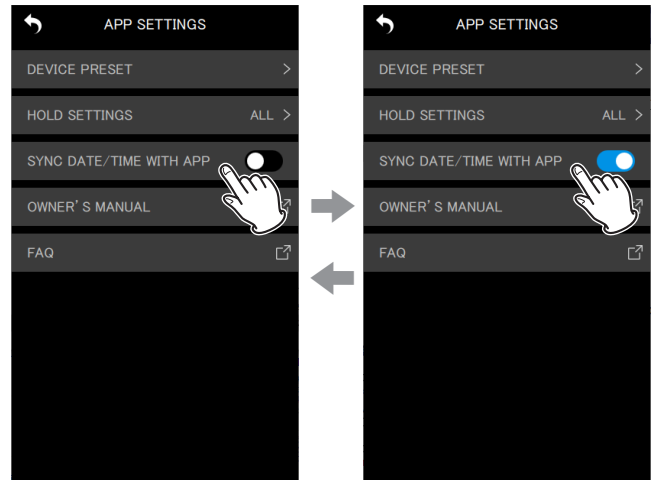

11-3. Connecting wireless audio monitoring devices to different FR-AV2 units

By turning on/off the wireless audio monitoring functions for an FR-AV2 on the AUDIO MONITORING MONITOR SELECT screen, a connected wireless audio monitoring device can be reconnected to a different FR-AV2.

NOTE

- The wireless audio monitoring device must be paired with the FR-AV2 that it will be reconnected with in advance. Moreover, the wireless audio monitoring device must also be the last one connected to the FR-AV2 to which you want to reconnect it.
- For devices that have the wireless audio monitoring functions setting on, only the last connected wireless audio monitoring device can be connected again. Even wireless audio monitoring devices that have been paired cannot be reconnected if they were not the last one connected.

1. Tap AUDIO MONITORING on the APP SETTINGS Screen.

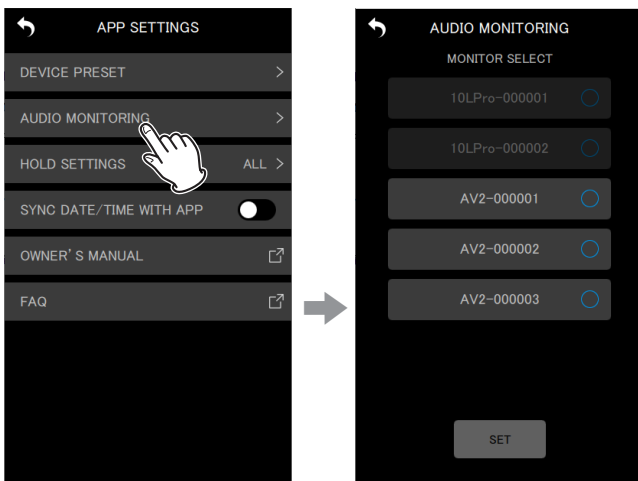

This opens the AUDIO MONITORING MONITOR SELECT screen.

2. Tap the FR-AV2 to which you want to reconnect a wireless audio monitoring device.

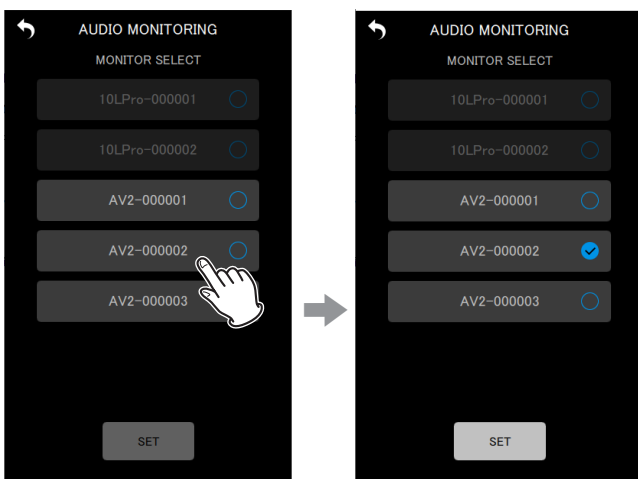

A check mark will be shown.

NOTE

Only one device can be selected. When one FR-AV2 is selected, other devices will be automatically deselected. Wireless audio monitoring devices that are currently connected will automatically be disconnected.

3. Press the SET button.

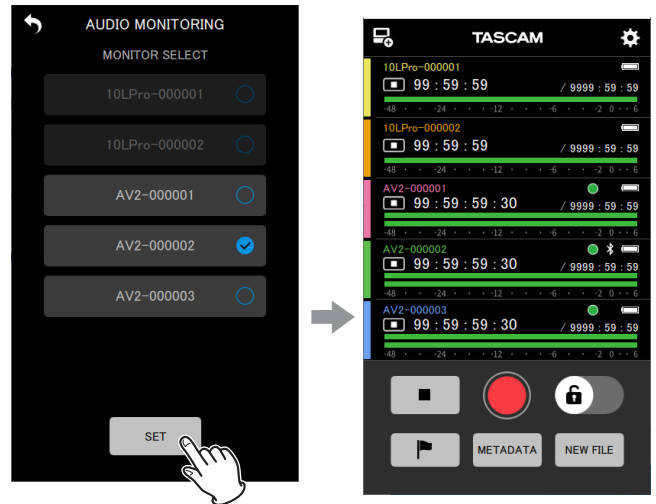

The setting will be applied and the Home Screen will reopen. After connection with the wireless audio monitoring device has completed, the Bluetooth icon will be shown for the device that has the wireless audio monitoring functions on. This completes reconnection.

NOTE

If you also want to enable AUDIO MONITORING for other devices, use the BLUETOOTH menu on the SETTINGS Screen for individual devices. (see "SETTINGS Screen (FR-AV2)" on page 36)

11-4. Editing metadata

After metadata (project names, scene names and take numbers) is set, it can be added to the iXML data of files recorded later. Set the metadata to be added on the METADATA Screen.

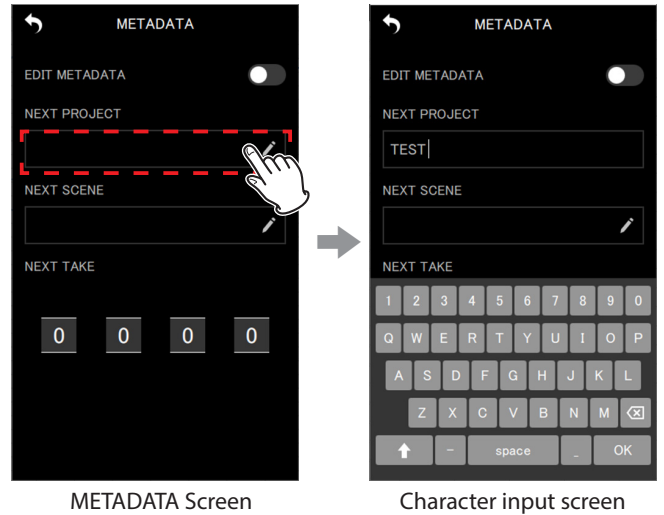
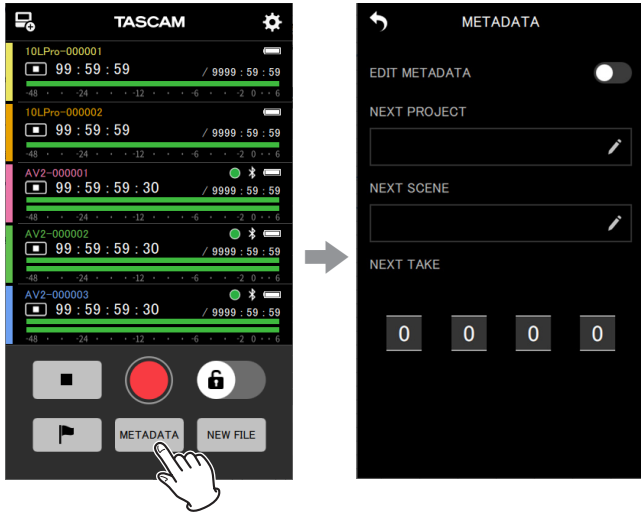

METADATA Screen

Character input screen

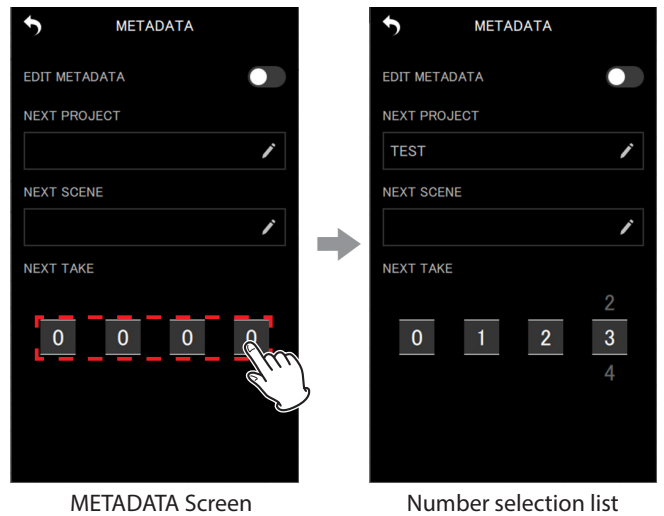

METADATA Screen

Number selection list

NOTE

If EDIT METADATA is set to on, the NEXT TAKE number will be applied to the ends of file names.

METADATA Screen

The data that will be written to iXML can be set on this screen.

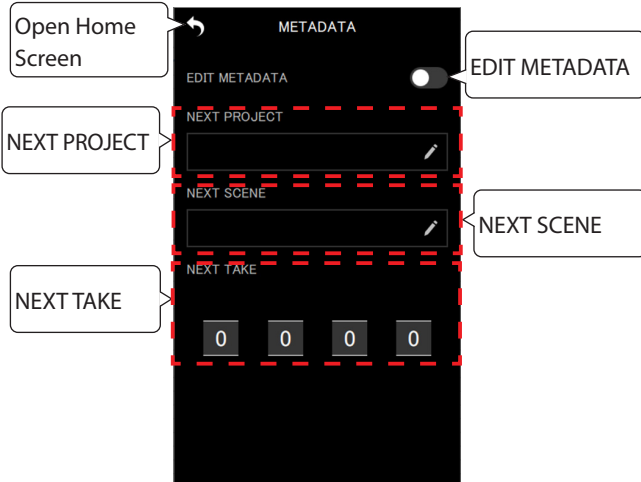

EDIT METADATA	This turns the metadata editing function on/off.
NEXT PROJECT	Input a project name with 15 characters or less. Tap inside the field to open the character input keyboard.
NEXT SCENE	Input a scene name with 15 characters or less. Tap inside the field to open the character input keyboard.
NEXT TAKE	Set the take number. Tap the number fields to open number selection lists.

If EDIT METADATA is set to on, the data will be transmitted to the connected devices when the Home Screen is reopened.

11-5. Identifying the unit being controlled

This causes the device display to blink, enabling confirmation of the unit being controlled.

1. Tap the  icon at the top right of the individual unit screen.

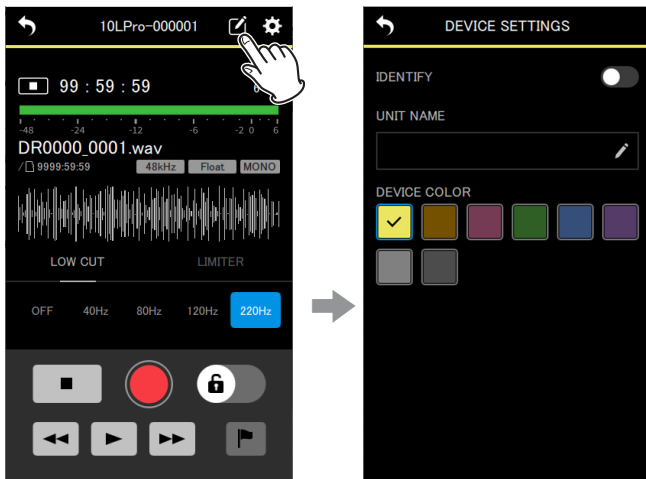

This opens the DEVICE SETTINGS Screen.

2. Tap "IDENTIFY".

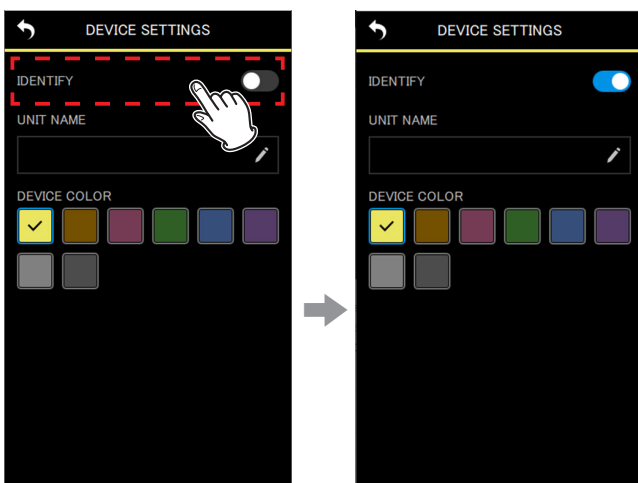

This turns on the IDENTIFY function, which causes the display of the corresponding unit to blink.

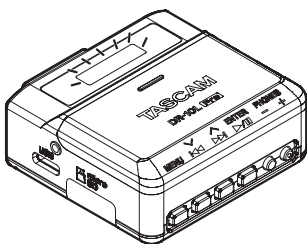

Example: DR-10L Pro

NOTE

- While IDENTIFY is on, the display of the corresponding unit will blink.
- The IDENTIFY function will turn off automatically when the DEVICE SETTINGS Screen is reopened.

11-6. Setting the UNIT NAME

The UNIT NAME can be set to give the device the desired name.

- The UNIT NAME is used for the device name display.
- The UNIT NAME can be added to the names of files with recording.
- When a microSD card is formatted, the UNIT NAME will be used for the volume label.

The UNIT NAME is set on the DEVICE SETTINGS Screen of the individual unit.

1. Tap the  icon at the top right of the individual unit screen.

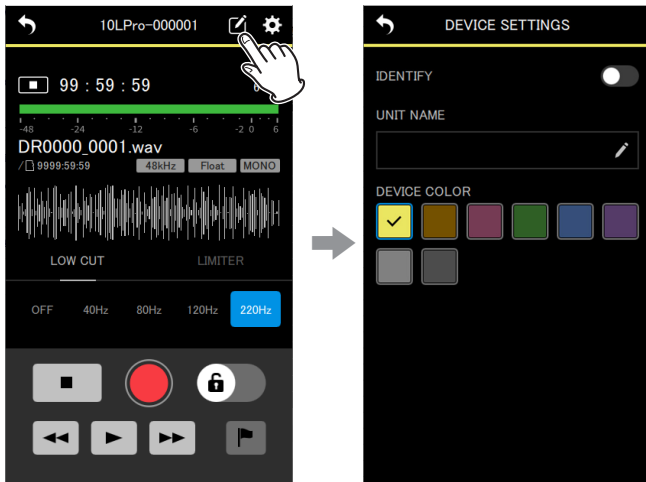

This opens the DEVICE SETTINGS Screen.

2. Tap the UNIT NAME input field.

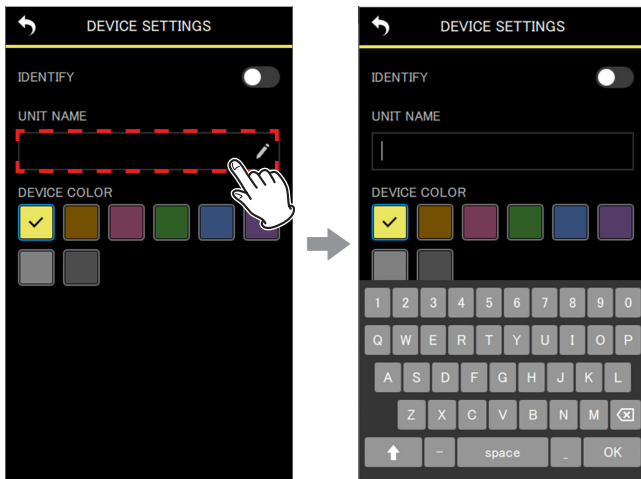

A keyboard will be shown.

3. Input the UNIT NAME.

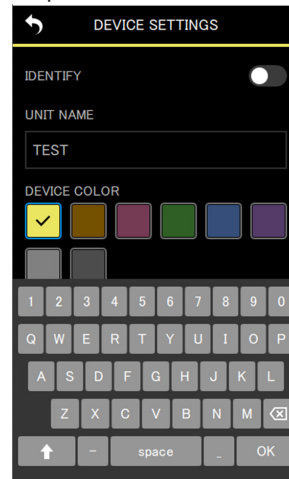

4. Tap the  icon at the top left.

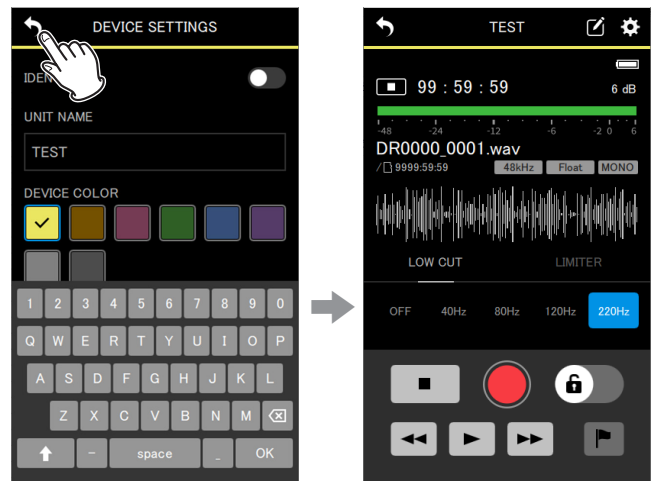

The UNIT NAME change will be applied and the individual unit screen will reopen.

11-7. Setting the DEVICE COLOR

Colors can be selected and set for each unit.
The DEVICE COLOR is used for various device indications on the Home Screen and the individual unit screen.

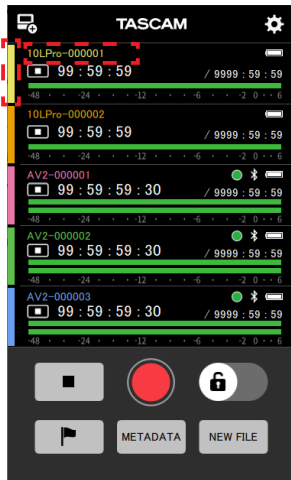

Areas where colors are shown on the Home Screen



Areas where colors are shown on individual unit screens

The DEVICE COLOR is set on the DEVICE SETTINGS Screen of the individual unit.

1. Tap the  icon at the top right of the individual unit screen.

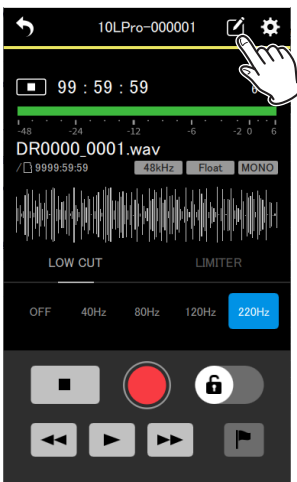

This opens the DEVICE SETTINGS Screen.

2. Tap the desired color.

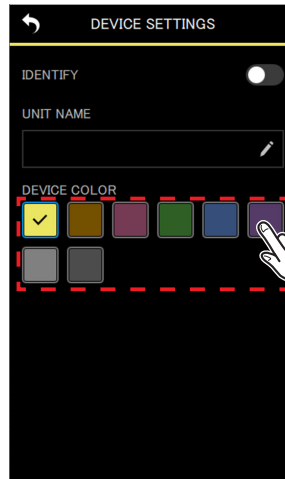

The color will be applied as soon as it is tapped.

3. Tap the  icon at the top left.

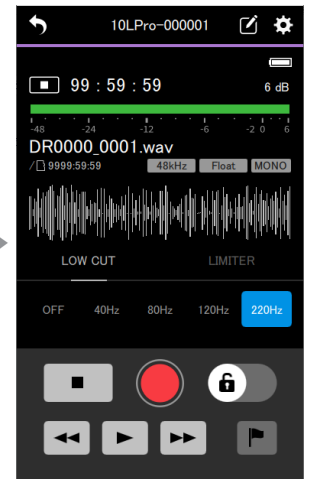
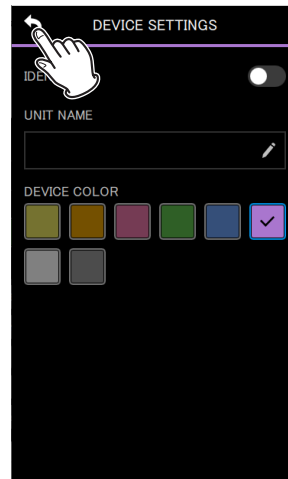

This reopens the individual unit menu.

NOTE

- The same color can be set for multiple units.
- Since color settings are saved in the devices, the same colors will be shown the next time they are connected.

TASCAM

TEAC CORPORATION

Phone: +81-42-356-9143

1-47 Ochiai, Tama-shi, Tokyo 206-8530 Japan

<https://tascam.jp/jp/>

TEAC AMERICA, INC.

Phone: +1-323-726-0303

10410 Pioneer Blvd., Unit #3, Santa Fe Springs, CA 90670, U.S.A

<https://tascam.com/us/>

TEAC UK Ltd.

Phone: +44-1923-797205

Luminous House, 300 South Row, Milton Keynes, Buckinghamshire, MK9 2FR, UK

<https://www.tascam.eu/en/>

TEAC EUROPE GmbH

Phone: +49-611-71580

Bahnstrasse 12, 65205 Wiesbaden-Erbenheim, Germany

<https://www.tascam.eu/de/>

TEAC SALES & TRADING(SHENZHEN) CO., LTD

Phone: +86-755-88311561-2

Room 817, Xinian Center A, Tairan Nine Road West, Shennan Road, Futian District, Shenzhen, Guangdong Province 518040, China

<https://tascam.cn/cn/>

1124.MA-3682C