

TASCAM

D01440220A

DR-07XP

Linear PCM Recorder

Owner's Manual

V1.00

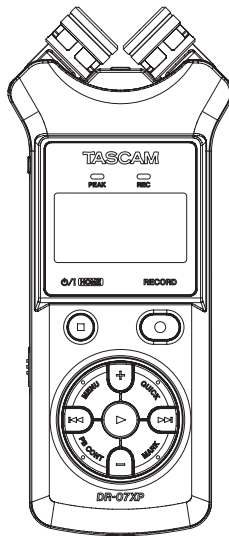

The following items are necessary to record and play files with this unit.
Please purchase any that are necessary for use.



- A microSD card
- 2 AA batteries

A list of microSD cards that have been confirmed for use with this unit can be found on the TASCAM website.
<https://tascam.jp/int/product/dr-07xp/docs>
The Owner's Manual can also be downloaded from the TASCAM website at the above URL address.

Contents

1. Introduction	4	4-8. Using the built-in microphone	36
1-1. Included items	4	Setting the mics to record a wide stereo sound (A-B position)	36
1-2. Features	5	Setting the mics to record a clear stereo sound (X-Y position)	36
1-3. Conventions used in this manual	6	4-9. Swapping the left-right channels of the built-in microphone pair	37
1-4. Trademarks and copyrights	6	Microphone position detection	37
1-5. Accessories sold separately	8	5. Recording	38
Using microSD cards	8	5-1. Setting file format, sampling frequency, type and maximum file size	38
Batteries	9	5-2. Setting where files are saved	40
Using a PS-P520U AC adapter	9	5-3. Making input settings	41
USB cables (for communication and data transmission)	9	5-4. Placing the unit and making connections	42
2. Quick Start Guide	10	Recording with the built-in mics	42
2-1. Preparation	10	Recording with external mics (MIC IN)	42
Inserting microSD cards (sold separately)	10	Recording an external device (EXT IN)	42
Installing batteries (sold separately)	10	5-5. Adjusting the input level	43
Starting up the unit	10	Manually adjusting the input level	43
Making initial settings	11	Using the LEVEL MODE function	44
2-2. Recording	12	5-6. Recording	46
Recording using the built-in mics	12	5-7. Recording playback and input sounds together (overdubbing)	47
2-3. Playing recordings	13	Select the file you want to overdub	47
Using the built-in speaker for playback	13	Selecting file format	47
3. Names and functions of parts	14	Enabling overdubbing mode	48
3-1. Top panel	14	Adjusting the input level	49
Other operation buttons (1)	15	Conducting overdubbing	49
Other operation buttons (2)	16	5-8. Recording automatically (AUTO REC)	50
3-2. Front panel	17	5-9. Continuing to record in a new file (track incrementing)	51
3-3. Rear panel	17	Manual track incrementation during recording ..	51
3-4. Left side	18	Automatic track incrementation by file size ..	51
3-5. Right side	18	5-10. Capturing a few seconds before starting recording (PRE REC)	52
3-6. Bottom	19	5-11. Self-timer	53
3-7. Home Screen	20	5-12. Using tone output	53
3-8. Recording Screen	22	Setting the AUTO TONE	54
3-9. Playback Control Screen	23	Setting the AUTO TONE length	54
3-10. Using the menu	24	Adjusting the AUTO TONE volume	55
3-11. Basic operation	25	5-13. Recording duration	56
3-12. Menu item list	26	6. Working with Files and Folders (Browse Screen)	57
4. Preparation	28	6-1. Opening the Browse Screen	57
4-1. Preparing the power supply	28	6-2. Screen navigation	57
Using AA batteries	28	6-3. Icons on the Browse Screen	58
Using an AC adapter (sold separately)	28	6-4. File operations	58
Using USB bus power	29	6-5. Folder operations	59
4-2. Turning the unit on and off	30	6-6. Creating a new folder	59
Starting up the unit	30	7. Playback	60
Making settings the first time the power is turned on	30	7-1. Adjusting the playback volume	60
Turning the unit off	31	7-2. Setting the playback area (AREA)	61
Resume function	31	7-3. Selecting a folder for the playback area (1)	62
4-3. Setting the date and time	32	7-4. Selecting a folder for the playback area (2)	63
4-4. Inserting and removing microSD cards (sold separately)	33	7-5. Using the playlist	64
Inserting microSD card	33	Adding files to the playlist	64
Removing the card	33	Editing the playlist	65
4-5. Preparing microSD (sold separately) cards for use ..	33		
4-6. Using the built-in speaker	34		
4-7. Connecting monitoring equipment	35		

7-6. Selecting files for playback (skipping)	66	13-5. Using as a USB audio interface	91
7-7. Playing recordings	66	Opening the AUDIO I/F Screen	91
Pausing	66	Setting the connected device type	92
Stopping	66	Connecting	92
Searching backward and forward	66	14. Settings and Information	93
7-8. Repeat playback (REPEAT)	67	14-1. Viewing information (INFORMATION)	93
7-9. Special playback control functions	68	File information page (FILE)	93
Playback Control Screen	68	Card information page (CARD)	94
Loop playback of a selection	68	System information page (SYSTEM)	94
Changing the playback speed (VSA)	69	14-2. System Settings	95
7-10. Setting the playback equalizer	70	Setting the automatic power saving function	95
7-11. Increasing the perceived overall sound pressure to		Setting the backlight	95
enhance listenability (LEVEL ALIGN)	71	Adjusting the display contrast	96
7-12. Using the jump function	72	Setting the battery type	96
Setting the jump back time	73	Set the language	97
Setting the jump forward time	74	Restoring the factory settings	98
8. Quick Operations	75	Formatting microSD cards	98
8-1. Features of the QUICK button	75	Erasing and formatting microSD cards	99
8-2. Quick menu	76	14-3. Setting the file name format	100
8-3. Deleting files	76	14-4. Using a 2D code to access the Owner's Manual web	
8-4. Dividing the selected file (DIVIDE)	77	page	101
8-5. Overwrite recording	78	15. Message	102
Selecting a file to overwrite record	78	16. Troubleshooting	104
Activating overwrite recording mode	78	17. Specifications	105
Conducting overwrite recording	78	17-1. Ratings	105
Checking the result of recording	78	17-2. Input/output ratings	105
Undoing and redoing	78	Analog audio input/output ratings	105
Ending overwrite recording mode	78	Control input/output ratings	106
8-6. Transcribing recorded files (DICTATION PLAY)	79	17-3. Audio performance	106
Enabling DICTATION PLAY mode	79	17-4. Other specifications	106
Adjusting the playback equalization	79	17-5. Dimensional drawings	108
Changing the playback position	79		
Changing the playback volume and speed	79		
Exiting DICTATION PLAY mode	80		
9. Timer recording functions	81		
9-1. Setting times for timer recording	81		
9-2. Turning on the timer recording function	82		
10. Mark functions	84		
10-1. Adding marks manually	84		
10-2. Adding marks automatically to a recording	84		
10-3. Moving to mark positions	84		
10-4. Clearing marks	84		
11. Using the effects	85		
11-1. Setting the effect	85		
Effects Preset List	85		
12. Tuning an instrument	86		
12-1. Using the tuner	86		
Setting the tuner	86		
Tuning a musical instrument	87		
Adjusting the input level for tuning	87		
13. USB connection	88		
13-1. Powering the unit with USB bus power	88		
13-2. Using as an SD card reader	89		
13-3. Disconnecting the unit from a computer	90		
13-4. Transferring files from a computer	90		

1. Introduction

Thank you very much for purchasing the TASCAM DR-07XP. Before using this unit, read this Owner's Manual carefully so that you will be able to use it correctly and enjoy working with it for many years.

After you have finished reading this manual, please keep it in a safe place for future reference.

1-1. Included items

This product includes the following items.

Take care when opening the package to avoid damaging the items. Keep the box and packing materials for transportation in the future.

Please contact the store where you purchased this unit if any of these items are missing or have been damaged during transportation.

Main unit × 1

Safety Guide (with warranty) × 1

TASCAM ID registration guide × 1

The Owner's Manual can be downloaded from the TASCAM website.



<https://tascam.jp/int/product/dr-07xp/docs>

1-2. Features

- Compact audio recorder that uses microSD/microSDHC/microSDXC cards as recording media
- High-performance stereo unidirectional microphone pair
- Stereo recording with different qualities is possible by opening or closing the mic pair
Closed (X-Y): clear stereo sound with less phase difference
Open (A-B): wide stereo sound
- Recording in 44.1/48/96 kHz, 32-bit float and 16/24-bit linear PCM (WAV) formats possible
- BWF format WAV files supported
- 32–320 kbps MP3 format recording possible (compatible with v2.4 ID3 tags)
- Overdubbing allows playback and input signals to be mixed and recorded together as a new file
- Built-in 0.3 W mono output speaker
- Built-in effect (reverb) can be used during recording and playback
- Automatic recording function starts recording automatically when a set sound input level is detected
- When the maximum file size set in advance is reached, a new file can be started automatically without interrupting recording (file incrementation function)
- QUICK button provides easy access to various functions
- Track incrementing function allows a recording to be split by creating a new file when desired
- Pre-recording function allows the unit to record the 2 seconds of sound before recording is activated
- Automatic peak reduction function automatically reduces the level suitably when the input level is too high
- Automatic level control can increase or decrease the recording volume when the input sound is too quiet or loud
- Limiter function automatically reduces the level suitably in particular portions where the input level is too high
- Low cut filter convenient for reducing low-frequency noise
- VSA function can change playback speed in a range from 50–200% (0.5 to 2.0 in 0.1 increments) of normal without changing pitch
- Repeat playback and IN-OUT loop playback functions
- PB CONT button opens screen for playback speed and IN-OUT loop settings
- Tuner function to tune musical instruments
- Self-timer function to start recording after a set period of time
- Timer recording that can start and stop at set times
- Jump function that moves backward or forward a small amount during playback or when paused (DICTATION PLAY mode only)
- Playlist function
- DIVIDE function allows files to be split where desired after recording (WAV files only)
- MARK function convenient for moving to specific locations
- Playback equalizer function and level alignment function to enhance the perceived overall sound pressure
- File name format can be set to use a user-defined word or the date
- Resume function to memorize the playback position before the unit is turned off.
- 3.5 mm (1/8") jack for external stereo microphone input (provides plug-in power) or external stereo line input
- 3.5 mm (1/8") line/headphone output jack
- 128×64-pixel LCD with backlight
- USB Type-C port (cable sold separately)
- Operates on 2 AA batteries (sold separately), a TASCAM PS-P520U AC adapter (sold separately) or USB bus power
- Tripod attachment screw hole
- USB audio interface functions
- Dictation playback mode
- Overwrite recording function

1. Introduction

1-3. Conventions used in this manual

We use the following conventions in this manual.

- “microSD/microSDHC/microSDXC memory card” is sometimes abbreviated as “microSD card”.
- Words that appear on the computer display are shown in quotation marks like this: “DR-07XP”.
- As necessary, additional information is provided under TIP, NOTE and CAUTION headings.

TIP

These are tips about how to use the unit.

NOTE

Notes provide additional explanations for special situations.

CAUTION

Failure to follow these instructions could result in damage to equipment or lost recording data, for example.

⚠ CAUTION

Failure to follow these instructions could result in injury.

1-4. Trademarks and copyrights

- TASCAM is a registered trademark of TEAC Corporation.
- The microSDXC Logo is a trademark of SD-3C, LLC.



- The MPEG Layer-3 audio coding technology is licensed from Fraunhofer IIS and Thomson.
- Supply of this product does not convey a license nor imply any right to distribute MPEG Layer-3 compliant content created with this product in revenue-generating broadcast systems (terrestrial, satellite, cable and/or other distribution channels), streaming applications (via Internet, intranets and/or other networks), other content distribution systems (pay-audio or audio-on-demand applications and the like) or on physical media (compact discs, digital versatile discs, semiconductor chips, hard drives, memory cards and the like). An independent license for such use is required. For details, please visit <http://mp3licensing.com>.
- ASIO is a trademark of Steinberg Media Technologies GmbH.



- Other company names, product names and logos in this document are the trademarks or registered trademarks of their respective owners.

Information is given about products in this manual only for the purpose of example and does not indicate any guarantees against infringements of third-party intellectual property rights and other rights related to them. TEAC Corporation will bear no responsibility for infringements on third-party intellectual property rights or other liabilities that occur as a result of the use of this product.

Properties copyrighted by third parties cannot be used for any purpose other than personal enjoyment and the like without the permission of the right holders recognized by copyright law. Always use this equipment properly. TEAC Corporation will bear no responsibility for rights infringements committed by users of this product.

1. Introduction

1-5. Accessories sold separately

This product does not include the following items. Please purchase any that you need for your uses.

- A microSD card
- 2 AA batteries
- AC adapter (TASCAM PS-P520U)
- USB cable (for communication or data transfer)

Using microSD cards

This unit uses microSD cards for recording and playback. A list of microSD cards that have been confirmed for use with this unit can be found on the TASCAM website. You can also contact TASCAM customer support.



<https://tascam.jp/int/product/dr-07xp/docs>

Precautions for use

microSD cards are delicate media.

In order to avoid damaging microSD cards, take the following precautions when handling them.

- Do not leave them in extremely hot or cold places.
- Do not leave them in extremely humid places.
- Do not let them get wet.
- Do not put things on top of them or twist them.
- Do not hit them.
- Do not remove or insert them during recording, playback, data transmission or other access.
- Always put memory cards in cases when transporting them.

Formatting of microSD cards

microSD cards formatted by this unit are optimized to improve performance during recording. Use this unit to format the microSD cards to be used with it.

Batteries

To power this unit with batteries, prepare two batteries. Alkaline or Ni-MH AA batteries can be used.

Using a PS-P520U AC adapter

In this case, use a TASCAM PS-P520U AC adapter (sold separately).

NOTE

This unit does not have a battery charging function when using an AC adapter.

USB cables (for communication and data transmission)

A USB cable must be prepared to connect this unit to a computer (Windows/Mac) or smartphone. (We recommend a product that is USB-IF certified.)

This unit has a USB Type-C port.

Prepare a USB cable suitable for the USB port of the computer or smartphone being used.

NOTE

USB cables designed only for charging cannot be used.

Connecting to an iOS device with a lightning port

A genuine Apple Lightning to USB Camera Adapter and a commercially-available Type-A to Type-C cable are necessary.

Connecting to a computer or smartphone with a USB Type-C port

A commercially-available Type-C to Type-C cable is necessary.

Connecting to a smartphone with a USB micro-B port

A commercially-available micro-B to Type-C cable is necessary.

Connecting to a computer with a USB Type-A port

A commercially-available Type-A to Type-C cable is necessary.

2. Quick Start Guide

This section explains basic procedures from recording to playback using batteries for power.

2-1. Preparation

Inserting microSD cards (sold separately)

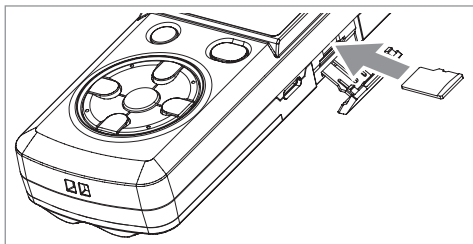

Open the cover on the side of the unit and insert a microSD card (sold separately).

NOTE

A list of microSD cards that have been confirmed for use with this unit can be found on the TASCAM website.



<https://tascam.jp/int/product/dr-07xp/docs>

Installing batteries (sold separately)

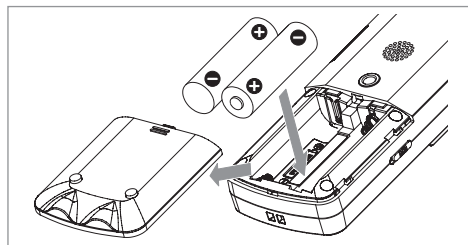

Install 2 AA batteries (sold separately) in the battery compartment on the back of the unit.

NOTE

- Use batteries that have sufficient remaining charge.
- See "Preparing the power supply" on page 28 for instructions about powering the unit with an AC adapter or USB bus power instead of AA batteries.

Starting up the unit

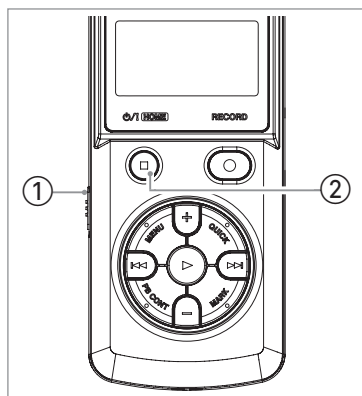

- ① Confirm that the HOLD switch on the side of the unit is set to the right side (in the direction opposite the arrow). (HOLD disabled.)

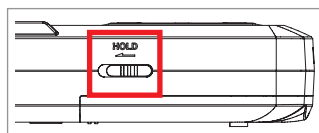

- ② Press and hold the power / (HOME) [■] button until the TASCAM DR-07XP (startup) screen opens. Then, release it.

Making initial settings

Setting the language

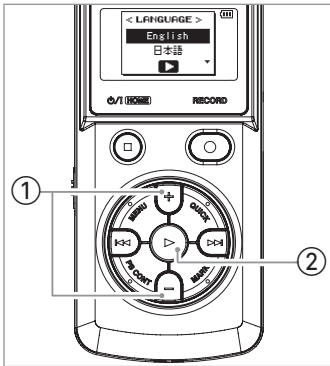

- ① Use the + and – buttons to select the language.
- ② Press the ► button to confirm.

Setting the date and time

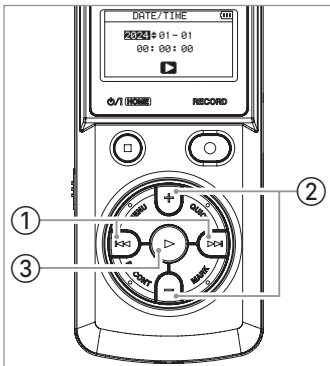

- ① Use the ◀◀ and ▶▶ buttons to move the cursor.
- ② Use the + and – buttons to change the values.
- ③ Press the ► button to confirm.

Formatting microSD cards

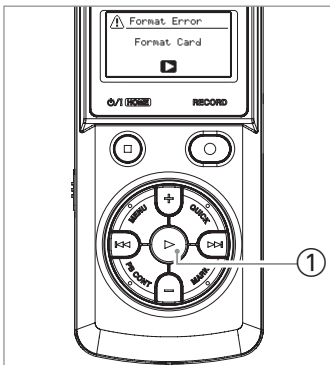

- ① Check the microSD card to be formatted, and press the ► button to confirm. This starts microSD card formatting.

CAUTION

Formatting a microSD card erases all data on that card.

After formatting completes, the Home Screen will appear.

2. Quick Start Guide

2-2. Recording

Recording using the built-in mics

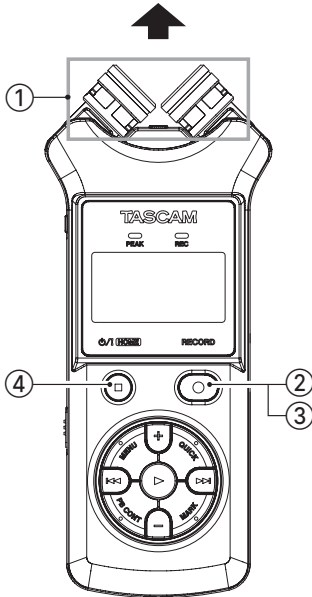

- ① Point the built-in mic toward the sound source.
- ② Press the RECORD [●] button to begin recording standby.

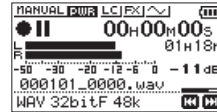

Screen when in recording standby

- ③ Press the RECORD [●] button again to start recording.
- ④ Press the $\text{\textcircled{H}}$ (HOME) [■] button to stop recording.

NOTE

- See "Recording" on page 38 for details about various recording settings, including adjusting the recording level, cutting low frequencies and using the limiter.
- See "Recording with external mics (MIC IN)" on page 42 and "Recording an external device (EXT IN)" on page 42 for details about recording with other connected mics and devices.

2-3. Playing recordings

Using the built-in speaker for playback

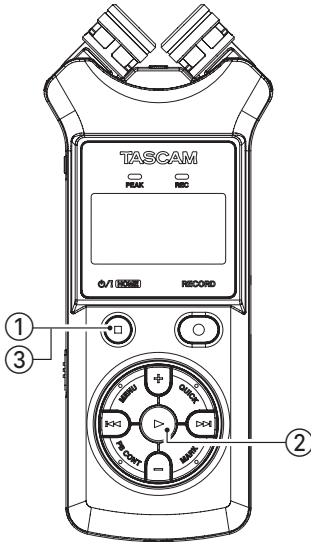

- 1 Press the $\square/|$ (HOME) [■] button to open the Home Screen.

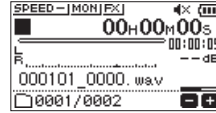

Home Screen

- 2 When the Home Screen is open, press the ► button. Playback of the newest recording will start with sound output from the built-in speaker on the back.
- 3 To pause during playback, press the $\square/|$ (HOME) [■] button.

NOTE

- For information about adjusting the volume and playback settings, including selecting playback files, and other details, see "Playback" on page 60.
- For information about using headphones and external monitoring systems for playback, see "Connecting monitoring equipment" on page 35.

If no playback sound can be heard

- Increase the playback volume.
- Turn on the speaker setting.
- Turn off overdubbing.
- Record so that the playback sound level meters reach at least halfway.
- Initialize the settings.

3. Names and functions of parts

3-1. Top panel

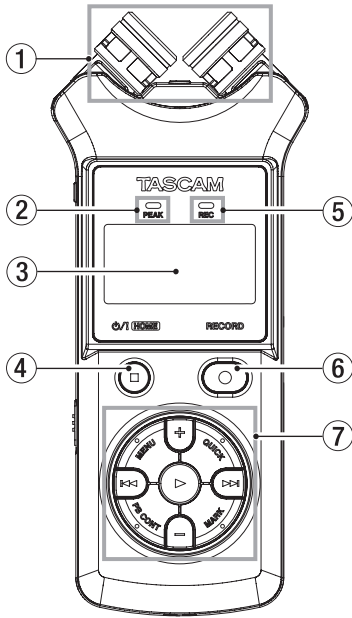

- ⑤ **REC indicator**
 - This flashes during recording standby.
 - This lights while recording.
- ⑥ **RECORD[●] button**
 - When stopped, press this button to put the unit into recording standby. The REC indicator will start to blink.
 - When in standby, press to start recording. The REC indicator will light when recording.
 - When recording, press to pause recording.
- ⑦ **Other operation buttons**

See "Other operation buttons (1)" on page 15 and "Other operation buttons (2)" on page 16 for details.

- ① **Built-in stereo microphone**

This is a stereo pair of unidirectional electret condenser mics. You can set the microphones to open (A-B) or closed (X-Y).
- ② **PEAK indicator**

Lights when the input volume is too high.
- ③ **Display**

Displays a variety of information.
- ④ **⏻/⏪ (HOME) [■] button**
 - Press and hold this button to turn the power on/off.
 - Press during playback to pause playback at the current position.
 - Press this button when paused to return to the beginning of that file.
 - Press when recording or in recording standby to stop recording.
 - When any other screen is open, press to return to the Home Screen.

3. Names and functions of parts

Other operation buttons (1)

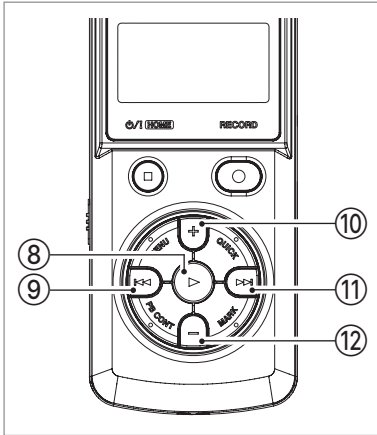

8 ▶ button

- When the Home Screen is open and playback is stopped, press to start playback.
- During playback, press this button to start jump-back playback.
- When a file or folder is selected in the Browse Screen, press this button to return to the Home Screen and play the file or the first file in the folder from the beginning.

9 ◀ button

- Press this button to return to the beginning of a file that is playing or stopped in the middle.
- If a loop playback starting (IN) or ending (OUT) point is set between the current position and the beginning of the file, press this button to skip to that point.
- Press when a track is stopped at its beginning to skip to the beginning of the previous track.
- Press and hold to search backwards.
- Press this button while pressing and holding the MARK button to return to the previous mark.
- On the setting screens, use this button to move the cursor left. Use this button to answer "NO" to a confirmation message.
- On the Browse Screen, press this button to move up a level.
- Press when recording or in recording standby to decrease the input level from the built-in microphone or MIC/EXT IN jack.

10 + button

- When the Home or TUNER Setting Screen is open, press to increase the output level from the built-in speaker or Ω /LINE OUT jack.
- When the Playback Control Screen is open, press to increase the playback speed.
- When a setting screen is open, use the button to change the setting of the selected item.

11 ►► button

- Press this button during playback or when playback is stopped to skip to the beginning of the next track.
- When IN and OUT points are set between the current position and the end of the track, press this button to skip to those points.
- Press and hold to search forward.
- On the setting screens, use this button to move the cursor right. Use this to confirm the selection of a setting item or to answer "YES" to a confirmation message.
- Press this button while pressing and holding the MARK button to move to the next mark.
- On the Browse Screen, press this button to move down a level. If a file is selected, the file is loaded, the Home Screen reopens and the unit stops.
- Press this button during recording or recording standby to increase the input level from the built-in microphone or MIC/EXT IN jack.

12 – button

- When the Home or TUNER Setting Screen is open, press to decrease the output level from the built-in speaker or Ω /LINE OUT jack.
- When the Playback Control Screen is open, press this button to decrease the playback speed.
- When a setting screen is open, use the button to change the setting of the selected item.

3. Names and functions of parts

Other operation buttons (2)

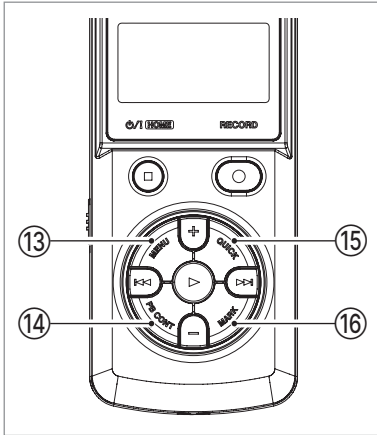

13 MENU button

- When the Home Screen is open, press this to open the MENU Screen. Press this button to return to the MENU Screen from the various setting screens.
- When the IN and OUT points are set in the track and the Playback Control Screen is open, press this to turn loop playback on or off.

14 PB CONT (Play Back Control) button

- This button activates the Playback Control Screen.
- When the Playback Control Screen is open, press to return to the Home Screen.
- Press during recording standby to turn off the self-timer function or change the time period.

15 QUICK button

- When playing back, stopped, paused or in recording standby when the Home Screen is open or when the Playback Control Screen is open, press this button to display the Quick menu. The functions shown depend on the state of the unit when the button is pressed.

Recorder status	Function shown
Stopped	Delete, divide and level alignment functions for the current file
Playing back or on Playback Control Screen	LEVEL ALIGN
Recording standby	LEVEL MODE

- When recording, press this button to increment the track, dividing the recording by creating a new file.
- When the Browse Screen or PLAYLIST Screen is open, press this button to open or close the pop-up menu for file/folder operations.

16 MARK button

- Use to add marks manually during recording and playback.
- Press when stopped at a mark location to delete that mark.
- Press the ◀◀ or ▶▶ button while pressing and holding this button to move to the previous or next mark, respectively. When the Playback Control Screen is open, use this button to set the IN (start) and OUT (end) points of the interval that you want to set for loop playback.
- When the IN and OUT points are already set, press this button to cancel loop playback and clear the IN and OUT points.

3. Names and functions of parts

3-2. Front panel

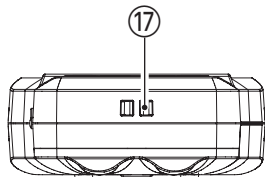

- ⑰ **Strap holder**
Use this to attach a strap.

3-3. Rear panel

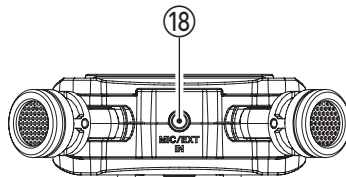

- ⑱ **MIC/EXT IN jack**
- Use this input jack to connect a stereo mini-jack microphone or an external input device. This supports plug-in power.
 - The built-in mic is disabled when an external mic is connected to the MIC/EXT IN jack.

3. Names and functions of parts

3-4. Left side

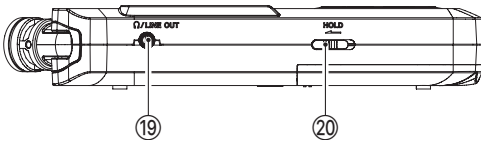

- ①⑨ **LINE OUT jack**
Use a stereo mini cable to connect headphones or the line input jack of other equipment to this.
- ②⑩ **HOLD switch**
Shift to the left end (in the direction of the arrow) to engage the hold function. No buttons can be used when HOLD is active.

3-5. Right side

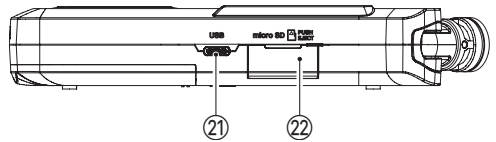

- ②① **USB port**
This is a Type-C USB port. Use a USB cable (sold separately) to connect the unit to a computer. (see "USB connection" on page 88)
- CAUTION**
- The unit should be connected directly to the computer, not through a USB hub.
 - Use a USB cable that is designed for data transmission or communication.
- ②② **microSD card slot**
Use this slot to insert and remove microSD cards. Use a microSD card that has been confirmed for use with this unit.
<https://tascam.jp/int/product/dr-07xp/docs>

3. Names and functions of parts

3-6. Bottom

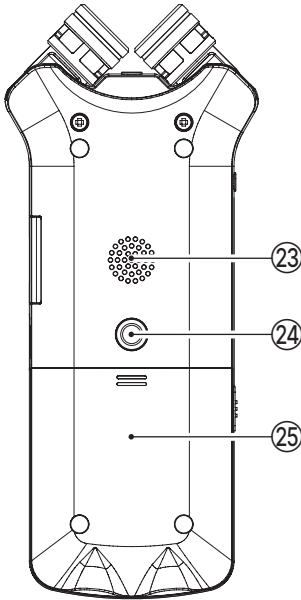

26 Battery compartment

Install batteries (2 AA) in this compartment to power the unit. (see "Using AA batteries" on page 28)

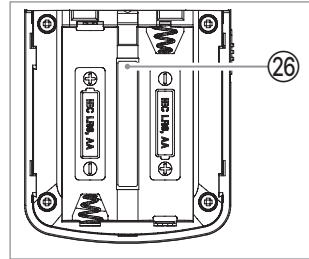

23 Mono speaker

Use this built-in speaker to listen to recordings. Sound will not be output when the unit is recording or in recording standby, when headphones are connected, when the speaker setting is off, when in overdubbing mode or when the volume of the recorded file is low.

24 Tripod attachment screw-hole (1/4-inch)

Use this to attach this unit to a tripod.

CAUTION

- Ensure the tripod or microphone stand screws are securely fastened to prevent the unit from falling off.
- When attaching this unit to a tripod or microphone stand, be sure to place it on a level surface.

25 Battery compartment cover

3. Names and functions of parts

3-7. Home Screen

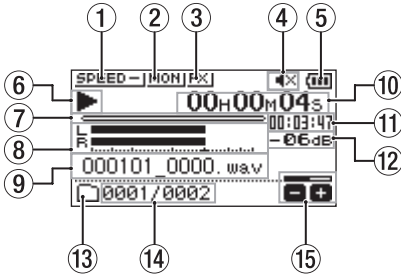

Home Screen when in ordinary operation mode

① Playback speed status

One of the following icons appears according to the playback speed setting.

Icon	Playback speed
	x1.0
	x1.1 - x2.0
	x0.5 - x0.9
	Playback speed not controllable

② Monitor Mix status

This shows the Monitor Mix function status.

: Monitor Mix disabled

: Monitor Mix enabled

③ Effect status

Shows whether the effect function is ON or OFF.

: Built-in effect off

: Built-in effect on

④ Speaker status

: Speaker output off

: Speaker output on

⑤ Remaining battery charge/power supply status

- A battery icon appears when power is supplied by batteries. When batteries are being used, a battery icon shows the amount of power remaining in bars (, , ,). The batteries are almost dead and the power will soon turn off if the icon with no bars blinks.
- When using a TASCAM PS-P520U AC adapter (sold separately) or USB bus power, appears.

NOTE

Sometimes a "Battery Low" warning appears when recording or conducting other demanding operations even when battery power remains.

⑥ Recorder operation status

This icon shows the recorder operation status.

Icon	Explanation
	Stopped
	Paused
	Playing back
	Searching forward
	Searching backward
	Skipping to the beginning of the next file
	Skipping to the beginning of the current or previous file

⑦ **Playback position display**
The current playback position is shown by a bar. As playback progresses, the bar extends from the left.

⑧ **Playback level meters**

- These show the levels of the input and playback signals.
- When in overdubbing mode, the levels of the mixed input and playback sounds are shown.

⑨ **Playback file name**

- The name or tag information of the file currently in play is displayed.
- The ID3 tag information is displayed instead when included in the MP3 file.

NOTE



ID3 tag information contains titles and artist names, which can be stored in MP3 files.

⑩ **Elapsed time**
This shows the elapsed time (hours: minutes: seconds) of the playing file.

⑪ **Remaining time**
This shows the remaining time of the playing file (hours: minutes: seconds).

⑫ **Peak value in decibels (dB)**
The maximum level that occurs in a fixed period of time is displayed digitally.

⑬ **Playback area**
This shows the current playback file area.

-  All files in the MUSIC folder
-  All files in the selected folder
-  All files added to the playlist

⑭ **Playback file number/total number of files**
This shows the current file number and total number of files in the playback area.

⑮ **Output volume status**
This shows the output volume status.

3. Names and functions of parts

3-8. Recording Screen

The Recording Screen shown below appears when recording or in recording standby.

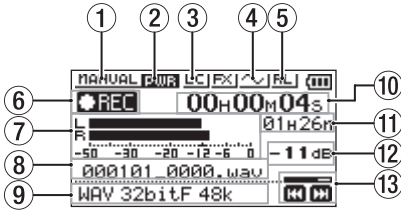

- ① **Level mode setting status**
This icon shows the level mode function setting.
MANUAL: MANUAL
LIMITER: LIMITER
PEAK : PEAK REDUCTION
AUTO : AUTO
- ② **Plug-in power status**
This shows whether plug-in power is on or off.
PWR: Plug-in power off
PWR: Plug-in power on
- ③ **Low cut filter status**
This shows whether the low cut filter is on or off.
LC: Low cut filter off
LC: Low cut filter on
- ④ **AUTO TONE setting status**
This icon shows whether the AUTO TONE function is on or off.
AUTO TONE off
AUTO TONE on
- ⑤ **Built-in stereo microphone left-right setting**
When not correct for the mic angle setting, the current left-right setting of the built-in stereo mics is shown.

Indications	Mic angles	MIC LR SWAP
LR	Closed (X-Y)	L-R
RL	Open (A-B)	R-L

- ⑥ **Recording status**
This icon shows the recorder operation status.

Icon	Explanation
●	Recording paused (recording standby)
REC	Recording

- ⑦ **Recording level meters**
 - The input signal levels are shown.
 - In overdubbing mode, the levels of the mixed input and playback sounds are shown.
- ⑧ **Recording file name**
The file name that will automatically be given to the recorded file is shown.
- ⑨ **Recording format**
This shows the format and sampling rate of the recorded file.
- ⑩ **Elapsed recording time**
The elapsed recording time of the file appears as hours: minutes: seconds.
- ⑪ **Remaining recording time**
When stopped, this shows the remaining time (hours: minutes) of the microSD card. When the remaining recording time becomes less than one minute, only seconds will be shown.
- ⑫ **Peak value in decibels (dB)**
Peak input level values are shown in decibels.
- ⑬ **Recording level status**
This shows the recording level status.

3-9. Playback Control Screen

During playback or when stopped, press the PB CONT button to open the Playback Control Screen.

Recording is not possible when this screen is open. The ◀◀ and ▶▶ buttons can also be used to skip to IN/OUT points and the file beginning/end. Skipping to the previous or next file is not possible.

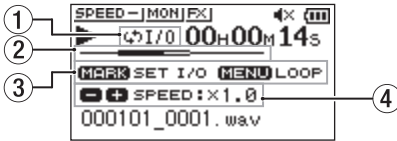

① **Loop playback status**

The ♫I/O icon appears when loop playback is enabled.

② **Playback position**

The current playback position is shown by a bar. As playback progresses, the bar extends from the left.

③ **Available buttons**

The buttons available in the Playback Control Screen are as follows.

Icon	Explanation
MARK	Creates or deletes an IN or OUT point.
MENU	Turn loop playback ON or OFF.

④ **Playback speed**

Playback speed as compared with the normal speed is shown. "SPEED" is shown first, indicating that the VSA function is enabled.

NOTE

The VSA (variable speed audition) function allows the tempo to be changed without changing the pitch.

3. Names and functions of parts

3-10. Using the menu

We will explain this by showing how to set the playback area as an example.

1. Press the MENU button to open the MENU Screen.

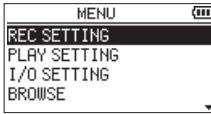

2. Use the + or – button to select a menu item (highlighted), and use the ► button to move to various settings screens.

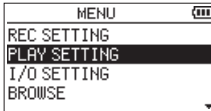

Example: PLAY SETTING is selected.

3. Use the + or – button to select a menu item to be set.

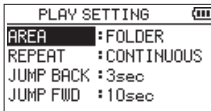

Example: AREA is selected.

4. Use the ►► or ► button to move the cursor to highlight the value of the setting.

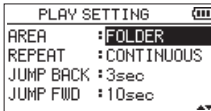

5. Use the + or – button to change the setting.

6. Press the ◀◀ button to set a different item in the same menu.
This enables selection of a different item. Use the + or – button to select another item to set.
7. Repeat step 3 to 6 as necessary to set other items.
8. Press the MENU button to open the MENU (or OTHERS) Screen.
9. To return to the Home Screen, press the ⏪/I (HOME) [■] button.

3-11. Basic operation

Use the following buttons to operate the various screens.

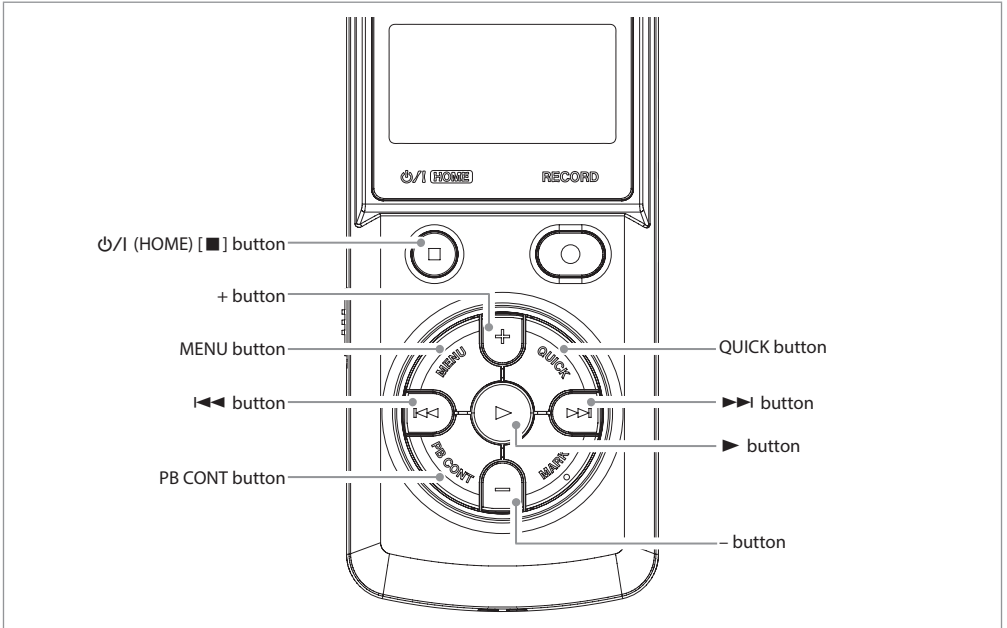

⏪/I (HOME) [■] button

When a settings screen is open, press the ⏪/I (HOME) [■] button to return to the Home Screen.

+ button

Use this to move the cursor (highlighted area) up on the screen and to increase values.

MENU button

This opens the MENU Screen.

⏪ button

Use this to move the cursor (the highlighted area) to the left on the screen, and to close folders on the Browse Screen.

Use this to answer "NO" to a confirmation pop-up message.

PB CONT button

This opens the Playback Control Screen.

QUICK button

This opens the Quick menu.

The content differs according to the recorder status and operation mode.

▶▶ button

Use this to move the cursor (highlighted area) right on the screen and to open folders on the Browse Screen. Use this to answer "YES" to a pop-up confirmation message.

▶ button

Use to confirm the various setting items.

- button

Use this to move the cursor (highlighted area) down on the screen and to decrease values.

3. Names and Functions of Parts

3-12. Menu item list

Press the MENU button to open the MENU Screen. The menu items are as follows.

Menu item	Function	Page	
REC SETTING	FORMAT	Set the recording format	see page 38
	SAMPLE	Set the sampling rate	
	CHANNEL	Set stereo or mono file	
	SIZE	Set the maximum file size (file incrementation function)	
	MIC POWER	Set plug-in power	see page 41
	LOW CUT	Set the low-cut filter	see page 41
	PRE REC	Set the pre-recording function	see page 52
	AUTO TONE	Set tone output	see page 54
	TONE SECS	Set the length of the output tone	see page 54
	TONE VOL	Set the volume of tone output	see page 55
	MODE	Set the auto-recording function mode	see page 50
LEVEL	Set the auto-recording start level	see page 50	
PLAY SETTING	AREA	Set the playback area	see page 61
	REPEAT	Set the repeat playback function	see page 67
	JUMP BACK	Set the jump back function	see page 73
	JUMP FWD	Set the jump forward function	see page 74
I/O SETTING	LEVEL MODE	Set the level mode function	see page 44
	SPEAKER	Turn the built-in speaker on/off	see page 34
	PLAYEQ	Set the playback equalization	see page 70
	LEVEL ALIGN	Set the output level alignment function	see page 71
BROWSE	Work with files and folders on the microSD card	see page 57	
TIMER REC	START TIME	Set the starting time for the timer recording function	see page 81
	END TIME	Set the ending time for the timer recording function	
	TIMER	Set the execution of the timer recording function	see page 82
OVERDUBBING	MODE	Set the overdubbing mode	see page 48
	PB LEVEL	Set the playback level when in overdubbing mode	
USB	SD CARD READER	Select the SD card reader mode	see page 89
	AUDIO I/F	Make USB audio interface settings	see page 91
OTHERS	INFORMATION	Information about the file, microSD card, and system	see page 101
	TUNER	Use the tuner	see page 86
	EFFECT	Make effect settings	see page 85
	FILE NAME	Set the recording file name	see page 100
	DATE/TIME	Set the date and time used by the unit	see page 32
MANUALS	Show a 2D code that can be used to access a document web page with the Owner's Manual and other resources.	see page 101	

3. Names and Functions of Parts

Menu item		Function	Page
SYSTEM	AUTO PWR SAVE	Set the automatic power saving function	see page 95
	BACKLIGHT	Setting the backlight	see page 95
	CONTRAST	Adjusting the display contrast	see page 96
	BATTERY TYPE	Set the type of batteries.	see page 96
	LANGUAGE	Set the language shown on the display	see page 97
	INITIALIZE	Restoring the factory settings	see page 98
	QUICK FORMAT	Format the microSD card	see page 98
ERASE FORMAT	Erase and format the microSD card	see page 99	

CAUTION

- When recording or in recording standby, only the following screens and items are shown.
 - REC SETTING Screen: MIC POWER, LOW CUT and AUTO REC items (AUTO REC setting cannot be changed)
 - OVERDUBBING Screen: MODE and PB LEVEL items (MODE setting cannot be changed)
 - EFFECT Screen: all items
- When the Playback Control Screen is open, pressing the MENU button will not open the MENU Screen. This turns the loop playback function on/off. (see "Loop playback of a selection" on page 68)

4. Preparation

4-1. Preparing the power supply

Power can be provided to this unit using two AA batteries (sold separately), a TASCAM PS-P520U AC adapter (sold separately) or a commercially-available USB cable (USB bus power).

Alkaline or Ni-MH batteries can be used.

To use USB bus power, see "Powering the unit with USB bus power" on page 88.

Using AA batteries

Open the battery compartment cover on the back of the unit. Fit two AA batteries to the + and - marks shown in the compartment, and close the battery compartment cover.

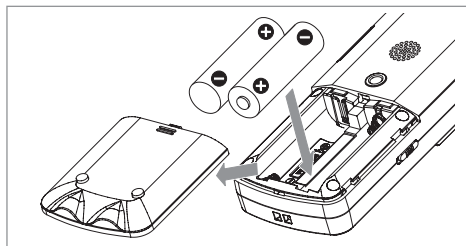

When using AA batteries, set the type of battery in order to accurately show the amount of power remaining and allow the unit to accurately determine whether power is available for proper operation. (see "Setting the battery type" on page 96)

CAUTION

- Manganese and lithium dry cell AA batteries cannot be used.
- This unit cannot recharge rechargeable batteries. Use a commercially available recharger.

Using an AC adapter (sold separately)

As shown in the illustration, connect a TASCAM PS-P520U AC adapter (sold separately) to the unit's USB port and power the unit.

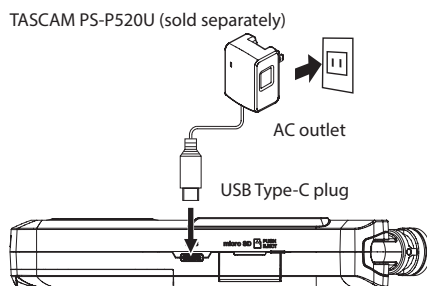

CAUTION

- Never use any adapter other than the designated PS-P520U AC adapter. Use of a different adapter could cause malfunction, fire or electric shock.
- Noise may occur when recording with a microphone if the unit is too close to the AC adapter. In such a case, keep sufficient distance between the AC adapter and the unit.

NOTE

When batteries are installed and the AC adapter is connected, power will be supplied from the AC adapter.

Using USB bus power

Use the commercially-available USB cable to connect the unit and the computer as illustrated below.

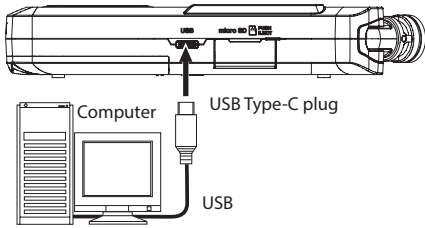

For details, see "Powering the unit with USB bus power" on page 88.

4. Preparation

4-2. Turning the unit on and off

⚠ CAUTION

Do not wear connected headphones when turning the unit on or off.

Noise could damage the headphone driver unit or harm your hearing.

CAUTION

- Turn down the volume of the monitoring system connected to the unit before turning the unit on or off.

Starting up the unit

When the unit is off, press and hold the $\text{O}/1$ (HOME) [■] button until the TASCAM DR-07XP start-up screen is shown on the display.

The Home Screen appears when the unit starts up.

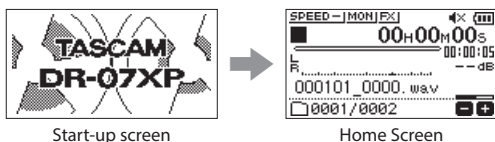

Making settings the first time the power is turned on

The first time a new unit is turned on after purchase, the following settings must be made.

- Setting the language shown on the display
- Setting the built-in clock

Setting the language shown on the display

A menu screen to set the display language will open.



1. Press the + or – button to move the cursor and select the language to be shown on the display.

Options

English: use English

日本語: use Japanese

Français: use French

Español: use Spanish

Deutsch: use German

Italiano: use Italian

Português: use Portuguese

Русский: use Russian

中文: use Chinese

한글: use Korean

2. After selection, press the ► button to confirm it.

You can change this setting with the SYSTEM Screen LANGUAGE item. (see "Set the language" on page 97)

Setting the built-in clock

A screen for setting the built-in clock will open.

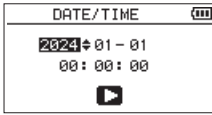

1. Use the ◀◀ or ▶▶ button to move the cursor, and use the + or - button to change values.
2. Press the ▶ button to fix the settings. The start-up screen is displayed, and then the Home Screen appears after the unit has started up.

TIP

Date/time adjustment may be skipped (and made later) by pressing the ▶ button. (see "Setting the date and time" on page 32)

Turning the unit off

Press and hold the ⏻/I (HOME) [■] button until LINEAR PCM RECORDER appears on the display.



The unit turns off after it completes its shutdown process.

CAUTION

Always use the ⏻/I (HOME) [■] button to shut down the unit.
Do not remove the batteries or disconnect the power cable (TASCAM PS-P520U AC adapter or USB cable) while the unit is on. If power is interrupted, the unit cannot shut down properly and all recordings, settings and other data will be lost. Lost data and settings cannot be restored.

Resume function

This unit has a resume function that retains the playback position when the power is off. After turning on the power, playback can be started from where it was last stopped.

NOTE

The data required for this is stored on the microSD card. The resume function will not work if the card is replaced or formatted.

4. Preparation

4-3. Setting the date and time

The DR-07XP uses its internal clock to record the date and time to the recorded files.

1. Press the MENU button to open the MENU Screen.

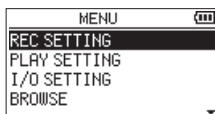

2. Use the + or – button to select OTHERS item, and press the ► button.

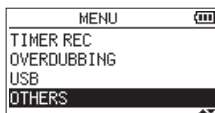

The OTHERS Screen opens.

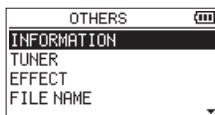

3. Use the + or – button to select the DATE/TIME item, and press the ► button.

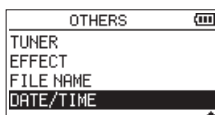

The DATE/TIME Screen opens.

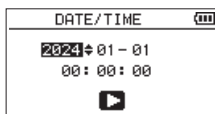

4. Use the ◀◀ or ▶▶ button to move the cursor, and use the + or – button to change values.
5. Press the ► button to confirm the change and return to the OTHERS Screen.

NOTE

You can set the unit to automatically add the date to file names. (see "Setting the file name format" on page 100)

CAUTION

The date and time setting can be retained for only a few minutes when power is not supplied from batteries, a dedicated AC adapter (TASCAM PS-P520U; sold separately) or USB bus power.

When using batteries, we recommend replacing them before they are completely dead.

4-4. Inserting and removing microSD cards (sold separately)

A microSD card is necessary to record and play files with this unit. Please purchase them separately. This unit can use microSD cards that are compatible with microSD, microSDHC or microSDXC standards. A list of microSD cards that have been confirmed for use with this unit can be found on the TASCAM website.

<https://tascam.jp/int/product/dr-07xp/docs>

Inserting microSD card

1. Open the microSD slot cover on the right side.
2. Insert the microSD Card into the slot as shown in the following illustration until it clicks into place.

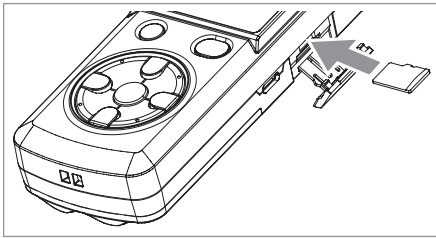

Removing the card

1. Open the microSD slot cover on the right side.
2. Press the microSD card gently and then release it to allow it to come out.

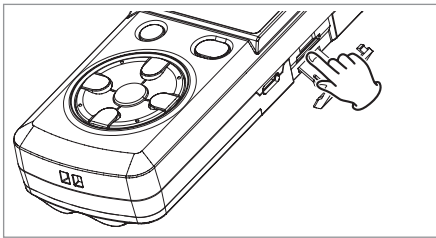

CAUTION

Do not remove the microSD card from the unit when it is connected to a computer by USB.

4-5. Preparing microSD (sold separately) cards for use

In order to use a microSD card in this unit, you must format it first.

1. Confirm that a microSD card is installed and turn the power ON.

A pop-up message like the following will appear when a new microSD card or one formatted for use with another device is installed in the unit.



2. Press the ► button to start formatting.

CAUTION

Formatting a microSD card erases all data on it.

When formatting ends, the Home Screen opens. You can also reformat the card in this unit at any time. See "Formatting microSD cards" on page 98 for details.

CAUTION

When formatting a microSD card, the batteries should have sufficient remaining power. Alternatively, the unit should be operating on power supplied by a TASCAM PS-P520U adapter (sold separately) or computer USB bus power. If the power turns off during formatting, proper formatting might not be possible.

4. Preparation

4-6. Using the built-in speaker

To listen to the playback sound from the built-in speaker, turn on the SPEAKER item on the I/O SETTING Screen.

NOTE

Even if SPEAKER is enabled, the unit will not play through the speaker when the unit is recording sound, in recording standby or muted with headphones or an external speaker system connected.

Operation from the MENU Screen

1. Press the MENU button to open the MENU Screen.

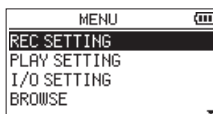

2. Use the + or – button to select the I/O SETTING item, and press the ► button.

The I/O SETTING Screen will open.

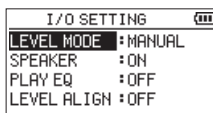

3. Use the + or – button to select the SPEAKER item and press the ►| or ► button.

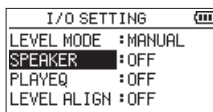

4. Use the + or – button to select ON.

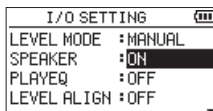

5. After completing the setting, press the ◂/| (HOME) [■] button to return to the Home Screen.

Operation from the Quick menu

1. During playback when the Home Screen is open, press the QUICK button to open the Quick menu.



2. Use the + or – button to select the SPEAKER item and press the ► button.

The SPEAKER Setting Screen will open.

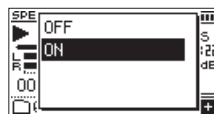

Options

OFF

ON (default)

3. Use the + or – button to select a setting, and press the ► button to enable it and return to the Home Screen.

4-7. Connecting monitoring equipment

To listen with headphones, connect them to the Ω /LINE OUT jack.

To listen with an external monitoring system (powered monitor speakers or an amplifier and speakers), connect it to the Ω /LINE OUT jack.

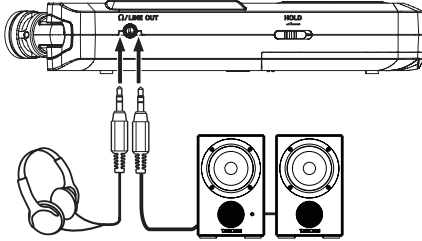

Headphones

Powered monitor speaker
or
an amplifier and speaker

4. Preparation

4-8. Using the built-in microphone

This unit's built-in microphones can be adjusted, allowing the angles of the microphones to be changed. You can choose clear stereo sound or wide stereo sound according to considerations including the recording source and situation by opening or closing the microphone pair.

Setting the mics to record a wide stereo sound (A-B position)

Open the mics to the left and right.

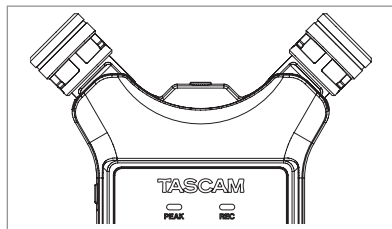

A-B position

Set this way, the two microphones are spread wide to the left and right, enabling recording with a strong stereo field that is good for music, for example.

If you open or close the microphone pair while using the built-in stereo microphone and the left-right setting does not suit the angle of the microphone, a pop-up message appears to ask whether you want to change the mic left-right setting. (see "Microphone position detection" on page 37)

CAUTION

Set the built-in stereo mic to setting to L-R. When using the built-in stereo microphone in an open state and the left-right setting is not L-R, **R/L** appears as light on dark on the Home Screen. (see "Swapping the left-right channels of the built-in microphone pair" on page 37)

Setting the mics to record a clear stereo sound (X-Y position)

Close the mics.

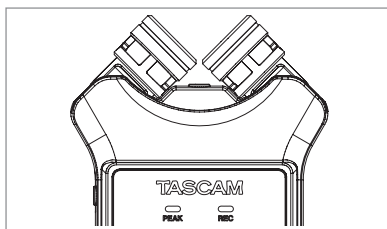

X-Y position

This setting enables recording with a clear stereo field and less phase difference.

If you open or close the microphone pair while using the built-in stereo microphone and the left-right setting does not suit the angle of the microphone, a pop-up message appears to ask whether you want to change the mic left-right setting. (see "Analog audio input/output ratings" on page 105)

CAUTION

Set the built-in stereo mic to setting to R-L. When using the built-in stereo microphone in a closed state and the left-right setting is not R-L, **R/L** appears as light on dark on the Home Screen. (see "Swapping the left-right channels of the built-in microphone pair" on page 37)

4-9. Swapping the left-right channels of the built-in microphone pair

Swap the left and right mics according on the mic angle setting. When the microphone pair is open, the left mic should be set to the left channel and the right mic should be set to the right channel (A-B position: L-R).

When the microphone pair is closed, the left mic should be set to the right channel and the right mic should be set to the left channel (X-Y position: R-L).

When using the built-in stereo microphone and this setting is not set, **RL** appears as light on dark on the Home Screen.

1. Press the RECORD [●] button to begin recording standby. The REC indicator flashes red and the recording screen opens.
2. Press the QUICK button. The Quick menu will open.

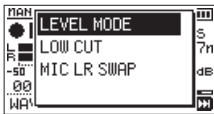

3. Use the + or – button to select MIC LR SWAP, and press the ► button. The L-R swap pop-up screen will open.

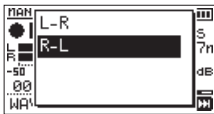

4. Use the + or – button to select L-R or R-L according to the MIC pair angle.

Mic angles	MIC LR SWAP
Open (A-B position)	L-R
Closed (X-Y position)	R-L

5. Press the ► button to fix the setting, and to return to the Home Screen.

Microphone position detection

The following pop-up message appears automatically whenever the built-in stereo mic is opened or closed and the left-right channel setting does not suit the mic angle.



Press the ►► button to change the setting.
Press the ◀◀ button to leave the setting as it is.

NOTE

- This screen appears automatically when the left mic is opened or closed. If only the right microphone is opened or closed, it does not appear.
- When you change the microphone angle setting and the pop-up message appears, you must press the ►► button to change the L-R setting, press the ◀◀ button to keep this setting as is, or restore the previous microphone angle to close the pop-up message before you can begin recording.
- The pop-up message does not appear if you change the microphone position when recording. If necessary, use the MIC LR SWAP setting by pressing the QUICK button to switch the setting after change the setting to recording standby mode by pressing the RECORD [●] button. (see "Swapping the left-right channels of the built-in microphone pair" on page 37)

5. Recording

In addition to the built-in microphone, an external microphone or external audio device (i.e. CD player) can also be used for recording.

You can select among MP3 (44.1/48 kHz, 32–320 kbps) and WAV (44.1/48/96 kHz, 16/24-bit, 32-bit float) audio recording formats.

Since the unit is compatible with the BWF format for WAV files, marks added to WAV files during recording are available when playing them back with BWF-compatible software, for example. With this unit, you can mix and record a sound input through the built-in mic or the input jack with an audio file that is played back using the overdubbing function.

32-bit float

- 32-bit float provides an extraordinarily wide dynamic range, enabling accurate recording of sounds that are both extremely quiet and incredibly loud.
- As long as input to the mic section is not excessive, sound clipping (breaking up) during recording is not a concern and levels can be adjusted suitably when editing afterward.
- When editing, audio quality can be maintained without loss even with large level adjustments, enabling great flexibility.

5-1. Setting file format, sampling frequency, type and maximum file size

Select the audio file type that you want to record before you start recording.

The following items will be set in order in this explanation as an example. Make each of these settings as necessary.

- Recording format
- Sampling frequency
- CHANNEL
- SIZE

1. Press the MENU button to open the MENU Screen.

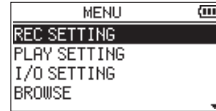

2. Use the + or – button to select the REC SETTING item, and press the ► button. The REC SETTING Screen opens.

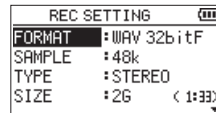

3. Use the + or – button to select the FORMAT item, and press the ►► or ► button.
4. Set the recording format with the + and – buttons.

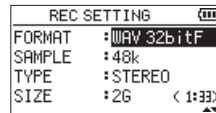

Options

WAV 16bit

WAV 24bit

WAV 32bitF (default)

MP3 32k

MP3 64k

MP3 96k

MP3 128k

MP3 192k

MP3 256k

MP3 320k

NOTE

- WAV formats provide better recording quality than MP3.
- MP3 formats enable longer recording times than WAV.
- MP3 formats with higher values provide better recording quality.

5. Press the **I◀◀** button to enable selection of settings.

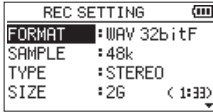

6. Use the + or – button to select the SAMPLE item, and press the **▶▶I** or **▶** button.
7. Set the sampling rate with the + and – buttons.

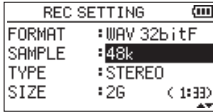

Options

44.1k

48k (default)

96k

NOTE

96k cannot be selected if FORMAT is set to MP3.

8. Press the **I◀◀** button to enable selection of settings.



9. Use the + or – button to select the TYPE item and press the **▶▶I** or **▶** button.
10. Set whether to use stereo or mono files with the + and – buttons.



Options

STEREO (default)

MONO

NOTE

If MONO is selected, a mono file is created, and the same signals are sent to both L and R level meters and output channels.

If set to record in MONO in WAV format, the file size will be half that when recorded in STEREO, allowing longer recording times.

5. Recording

11. Press the **I◀◀** button to enable selection of settings.

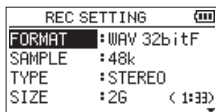

12. Use the **+ –** button to select the SIZE item, and press the **▶▶I** or **▶** button.

13. Set the maximum file size with the **+ and –** buttons.

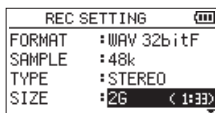

Options

64M

128M

256M

512M

1G

2G (default)

NOTE

- If the maximum set file size is exceeded during recording, the unit will automatically continue recording in a new file.
 - Depending on the file format, the amount of recording time will differ for the same file size. The amount of recording time is shown on the right of the setting value (in parentheses).
 - If the recording time exceeds 24 hours, the unit will automatically continue recording in a new file.
14. After completing the setting, press the **⏪/I (HOME) [■]** button to return to the Home Screen.

5-2. Setting where files are saved

Set the folder where recorded files are saved.

Recorded files will be saved in the currently selected folder. For details, see the SELECT pop-up menu item in "Folder operations" on page 59.

If no setting is made, new recording files are created in the "MUSIC" folder.

5-3. Making input settings

1. Press the MENU button to open the MENU Screen.

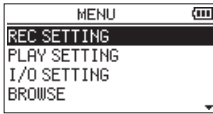

2. Use the + or - button to select the REC SETTING item, and press the ► button. The REC SETTING Screen opens.

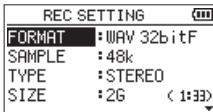

3. The following input settings are made on this screen. Use the ◀◀ or ▶▶ button and the + or - button to set each item.

MIC POWER

When connecting a microphone that requires plug-in power, set this to ON. (Default: ON)

LOW CUT

Set the cutoff frequency of the low-cut filter during input.

Options

OFF (default)

40Hz

80Hz

120Hz

220Hz

CAUTION

- Set MIC POWER to OFF when connecting a dynamic microphone, microphone with a built-in battery, or external audio device. If set to ON, the plug-in power may damage such microphones or generate noise.
- Use headphones to monitor when you are recording with a microphone. If you use speakers to monitor, the sound output from the speakers may also be recorded, causing a poor recording and even feedback.

NOTE

MIC POWER and LOW CUT can be set even when recording or in recording standby.

TIP

- The low cut filter can reduce noise such as offensive wind noise from air-conditioners and projectors.
- Use the built-in effects of this unit as necessary on the input source. (see "Using the effects" on page 85)

5. Recording

5-4. Placing the unit and making connections

Recording with the built-in mics

Point the mics at the sound source and place the unit in a stable location where there is little vibration.

Recording with external mics (MIC IN)

Connect an external mic to the MIC/EXT IN connector. Point the mic at the sound source and place the unit in a stable location where there is little vibration. When connecting a microphone that requires plug-in power, turn on mic power. (see "Making input settings" on page 41)

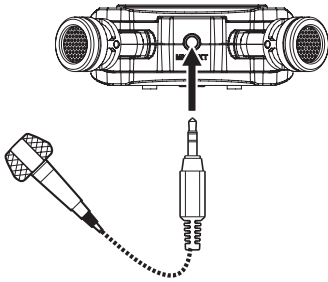

NOTE

The setting of left-right channels is disabled if an external mic is connected to the MIC/EXT IN jack.

Recording an external device (EXT IN)

Connect an external device to the MIC/EXT IN connector. Use a stereo mini cable to connect to the output of an external audio device.

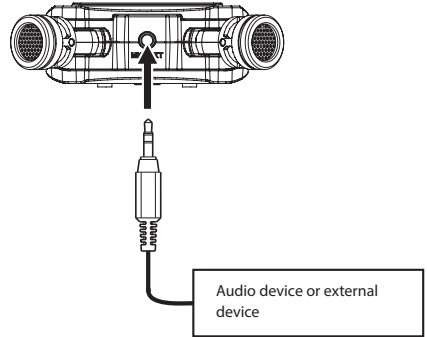

CAUTION

- Line level is not supported.
- If the input sound is still distorted after adjusting the input level of the unit, reduce the playback sound of the external device.

NOTE

Settings for the built-in stereo mic and mic left-right channels are disabled when an external device is being used.

5-5. Adjusting the input level

The input level can be adjusted to prevent sounds that are too loud from being distorted and sounds that are too quiet from becoming inaudible due to being masked by noise. Adjustment is also possible when 32-bit float is selected. With 32-bit float, adjusting to suitable levels afterward during editing is possible. Adjusting while recording, however, will make adjustment afterward easier.

CAUTION

This unit does not have a function for adjusting levels after recording. Make adjustments using, for example, editing software on a computer.

TIP

In addition to adjusting the INPUT level, try changing the distance and angle between the microphone and the sound source. The angle and distance of the microphone can also change the character of the recorded sound.

Manually adjusting the input level

NOTE

When using 32-bit float, the LEVEL MODE is always MANUAL.

Adjusting the input level

1. Press the RECORD [●] button to begin recording standby. The REC indicator flashes red and the recording screen opens.

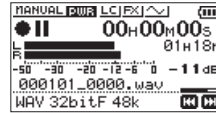

2. Use the ◀◀ or ▶▶ button to adjust the input level. Press the ◀◀ or ▶▶ button to show a pull-up MENU Screen for input level setting.

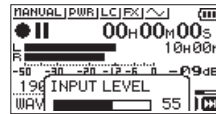

If the input is too high, the PEAK indicator on the upper left above the display lights.

A ▲ mark is provided at -12dB on the level meters.

Set the input level so that the indicator bars fluctuate centered on this mark without causing the PEAK indicator to light red when the loudest sounds occur.

NOTE

Even if no adjustments are made when recording with 32-bit float, levels can be adjusted suitably afterward when editing. If the PEAK indicator lights, however, the level is excessive at the input section, so move the unit farther away from the sound source.

NOTE

- Press the ◻/I (HOME) [■] button to exit recording standby.
- When in recording standby or recording, the speaker will not output sound even if the I/O SETTING Screen SPEAKER setting is on.

If you need to monitor sound to adjust the input level and make recordings, connect the headphone to the Ω/LINE OUT jack.

Use the + or - button on the Home Screen to adjust the monitoring volume. This does not affect the sound to be recorded.

5. Recording

Using the LEVEL MODE function

Operation from the MENU Screen

1. Press the MENU button to open the MENU Screen.

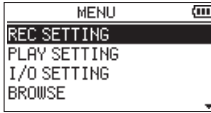

2. Use the + or – button to select the I/O SETTING item, and press the ► button. The I/O SETTING Screen will open.

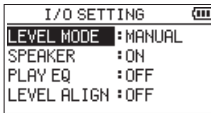

3. Use the + or – button to select the LEVEL MODE item, and press the ► button.

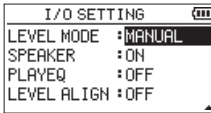

4. Use the + or – button to set the LEVEL MODE function.

Options

MANUAL (default)

Manually adjusting the input level

LIMITER

This function prevents distortion when signals that are too loud are input suddenly.

This mode is also suited for recording of live performances with large volume changes.

In this mode, the input level can be changed manually during recording.

CAUTION

Distortion of sounds may occur when excessively large input signals are input even if the LIMITER function is activated.

In such a case, lower the input level or increase the distance between the unit and the source.

PEAK REDUCTION

If the input sound is too loud, the input level is automatically lowered to a suitable level. This function makes handling difficult input level settings easier.

The input level can be raised manually if required.

TIP

When recording live performances, for example, you could test PEAK REDUCTION before the actual recording.

Select the PEAK REDUCTION mode in recording standby, and maximize the input level. By conducting a rehearsal performance, the input gain will be reduced to an appropriate level for recording, setting an optimum input level for the performance.

This set input level can be used for recording by turning this mode off (MANUAL) before starting recording. Otherwise, the input level will continue to be adjusted automatically in response to the input signal during recording.

AUTO LEVEL

Low input levels are raised and high input levels are lowered automatically, making this useful for recording meetings, for example. In this mode, the recording level cannot be changed manually.

5. After completing the setting, press the $\odot/1$ (HOME) [■] button to return to the Home Screen.

NOTE

When the recording format is 32-bit float, the LEVEL MODE will function as MANUAL regardless of its setting.

Operation from the Quick menu

1. Press the RECORD [●] button to begin recording standby. The REC indicator flashes red and the recording screen opens.
2. Press the QUICK button. The Quick menu will open.



3. Select **LEVEL MODE**, and press the ► button. This opens the LEVEL MODE Setting Screen.

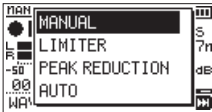

Options

MANUAL (default)

LIMITER

PEAK REDUCTION

AUTO LEVEL

4. Use the + and – buttons to select the function, and press the ► button. This enables it and reopens the Recording Screen. The selected mode is shown with an icon in the Recording Screen.

NOTE

When the recording format is 32-bit float, level adjustment becomes manual, and the level mode is shown in the Quick menu.

5. Recording

5-6. Recording

The following operation procedures assume that the input source is set, input level adjustment is complete, and the Home Screen is open.

1. Press the RECORD [●] button to begin recording standby.

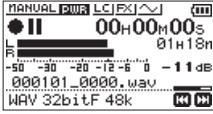

The screen shows the recording file name, the recording audio file type and sampling frequency. Confirm that these are as desired before starting recording.

2. To start recording, press the RECORD [●] button again. Normal recording starts.

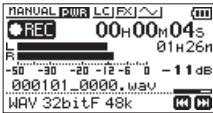

When recording starts, the REC indicator lights continuously, and the display shows the elapsed recording time and the remaining recording time.

3. To stop recording, press the \odot /I (HOME) [■] button. To pause recording, press the RECORD [●] button. Press the RECORD [●] button again to restart recording in the same file. If you press the \odot /I (HOME) [■] button while paused, a recorded audio file up to the moment that you paused recording is created.

CAUTION

Noise may occur when recording with a microphone if the unit is too close to the AC adapter. In such a case, keep sufficient distance between the AC adapter and the unit.

5-7. Recording playback and input sounds together (overdubbing)

By overdubbing, you can play an instrument or sing as you play back a saved track and mix and record both sounds in a new file.

NOTE

- The pre-recording and auto-recording functions are disabled when in overdubbing mode.
- When overdub recording, you cannot start new files manually.
- Pausing is not possible in overdubbing mode (RECORD [●] button is disabled).
- The sampling frequency of the playback file is preserved regardless of the sampling frequency setting for overdub recording.
- You cannot make an mp3 file when overdubbing a WAV file with a sampling frequency of 96 kHz.

Select the file you want to overdub

Use the ◀◀ and ▶▶ buttons and the Browse Screen to select that files that you want to overdub.

NOTE

See "Working with Files and Folders (Browse Screen)" on page 57 for selecting files using the Browse Screen.

Selecting file format

1. Press the MENU button to open the MENU Screen.

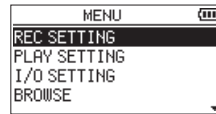

2. Use the + or – button to select the REC SETTING item, and press the ► button. The REC SETTING Screen opens.

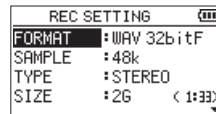

3. Use the + or – button to select the FORMAT item, and press the ▶▶ or ► button.
4. Set the file format with the + or – button.
5. After completing the setting, press the ◀/1 (HOME) [■] button to return to the Home Screen.

5. Recording

Enabling overdubbing mode

In overdubbing mode, the mixed input and playback sounds can be monitored.

NOTE

When in overdubbing mode, sound will not be output from the speaker even if the speaker setting is on.

1. Press the MENU button to open the MENU Screen.



2. Use the + or – button to select the OVERDUBBING item, and press the ► button. The OVERDUBBING Screen will open.

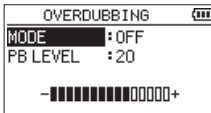

3. Use the + or – button to select the MODE item, and press the ►► or ► button.
4. Use the + or – button to select ON. (Default: OFF)

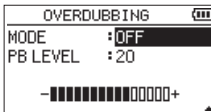

Monitoring of input sound is now enabled.

5. Press the I◀◀ button to enable selection of settings.
6. Use the + or – button to select the PB LEVEL item, and press the ►►I or ► button.

7. Use the + or – button to adjust the playback volume level.

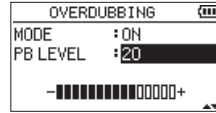

This can be set from 0–30. (Default: 20)

When set to 20, the playback level will be the same as it was when recorded.

8. After completing the setting, press the ◀/I (HOME) [■] button to return to the Home Screen. When in overdubbing mode, **OVERDUBBING** appears on the screen.

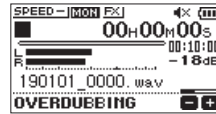

TIP

When in overdubbing mode, the playback control function can be used to practice singing or playing an instrument along with the playback sound.

Adjusting the input level

When in overdubbing mode, press the QUICK button to enable input level adjustment.

1. Press the QUICK button while the Home Screen is open during playback or when stopped. The Quick menu will open.



Quick menu when stopped

2. While listening to the input sound, use the ◀◀ or ▶▶ button to adjust the input level.

CAUTION

- When the Quick menu is open, the level meters cannot be viewed while making adjustments.
- At the level when distortion of the input sound is about to occur, the PEAK indicator on the left above the display will light. Adjust the input level so the PEAK indicator does not light.

NOTE

When in overdubbing mode, the PEAK indicator lights when the combined input and playback signals become higher than the set level.

Conducting overdubbing

1. Press the RECORD [●] button to begin recording standby.



The following error message appears if the selected file cannot be played back.



2. Press the RECORD [●] button. Overdubbing will start. When recording starts, the REC indicator lights and the display shows the elapsed and remaining recording times.
3. To stop recording, press the ⏻/I (HOME) [■] button.

5. Recording

5-8. Recording automatically (AUTO REC)

This function starts and pauses recording, starts new files, and sets marks automatically according to the input signal level.

1. Press the MENU button to open the MENU Screen.

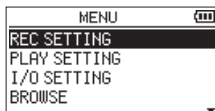

2. Use the + or - button to select the REC SETTING item, and press the ► button. The REC SETTING Screen opens.

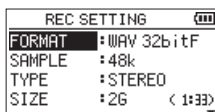

3. Use the + or - button to select the MODE item, and press the ►► or ► button.
4. Use the + and - buttons to set the AUTO REC MODE item.

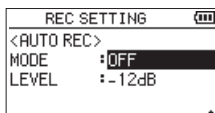

Options

OFF (default)

NEW FILE

Records and pauses automatically

MARK

Sets marks automatically during recording

5. Press the I◀◀ button to enable selection of settings.
6. Use the + or - button to select the LEVEL item, and press the ►►► or ►► button.

7. Use the + and - buttons to set the reference level for determining when signals are input.

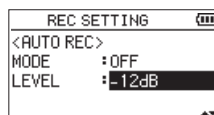

Options

-6dB

-12dB (default)

-24dB

-48dB

8. After completing the setting, press the ◊/I (HOME) [■] button to return to the Home Screen.
9. Press the RECORD [●] button to begin recording standby. Recording starts automatically when the input signal exceeds the LEVEL setting. Recording operation changes according to the MODE setting.

NEW FILE

If the input signal level falls below the standard level set by LEVEL for more than five seconds, the unit enters recording standby. When the input signal level becomes higher than the standard level, the unit starts recording a new file.

MARK

If the input signal level falls below the standard level set by LEVEL for more than five seconds, the unit adds a mark when the input signal level becomes higher than the standard level again.

10. To stop recording, press the ◊/I (HOME) [■] button.

TIP

By using this in combination with the PRE REC function, you can record events without losing the beginnings of sounds.

CAUTION

- The self-timer function cannot be used when using the AUTO REC function.
- The automatic recording function cannot be used when in overdubbing mode or when overwriting.

5-9. Continuing to record in a new file (track incrementing)

Recording of the current file can be stopped and recording continued in a new file automatically. This can be done manually or when the maximum file size set on the REC SETTING Screen is reached during recording (track incrementation function).

Manual track incrementation during recording

During recording, you can manually start a new file and continue recording.

Press the QUICK button while recording.

NOTE

Numbers at the end of file name will increment each time when a new file is created.

CAUTION

- A new file cannot be created if the total number of files and folders would exceed 5000.
- Files shorter than 2 seconds cannot be created. (4 seconds if the sampling frequency is 96 kHz).
- If the name of a newly created file would be the same as that of an existing file, the number will be incremented until the new file has a unique name.
- Track incrementing is not possible during overdub or overwrite recording.

Automatic track incrementation by file size

Recording of the current file can be stopped and recording continued in a new file automatically when the maximum file size set on the REC SETTING Screen is reached during recording.

Follow the procedures below to set the maximum file size.

1. Press the MENU button to open the MENU Screen.

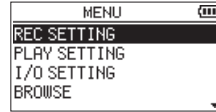

2. Use the + or – button to select the REC SETTING item, and press the ► button. The REC SETTING Screen opens.

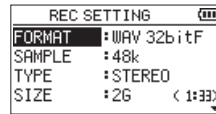

3. Use the + or – button to select the SIZE item, and press the ►► or ► button. Set the maximum file size for automatic track incrementation with the + and – buttons.

Options

64M

128M

256M

512M

1G

2G (default)

4. After completing the setting, press the ◀/1 (HOME) [■] button to return to the Home Screen.

CAUTION

A new file cannot be created if the total number of files and folders would exceed 5000.

NOTE

Depending on the file format, the amount of recording time will differ for the same file size.

5. Recording

5-10. Capturing a few seconds before starting recording (PRE REC)

By using prerecording, when the unit is in recording standby, up to two seconds of the signal input can be captured before recording starts.

1. Press the MENU button to open the MENU Screen.

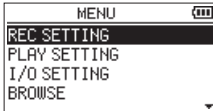

2. Use the + or - button to select the REC SETTING item, and press the ► button. The REC SETTING Screen opens.

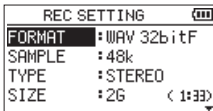

3. Use the + or - button to select the PRE REC item, and press the ►► or ► button.
4. Use the + or - button to select ON.

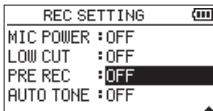

Options

OFF (default)

ON

5. After completing the setting, press the ϕ /I (HOME) [■] button to return to the Home Screen.

TIP

By using this in combination with the AUTO REC function, you can record events without losing the beginnings of sounds.

NOTE

- If you start recording within two seconds from when the record standby mode is turned ON, recording will begin from the moment of record standby.
- The automatic recording function cannot be used when in overdubbing mode or during overwrite recording.

5-11. Self-timer

Similar to a camera, the DR-07XP has a self-timer function to begin recording after a set period of time.

1. Press the RECORD [●] button when stopped or playing back to set the unit in recording standby. The REC indicator flashes red and the recording screen opens.

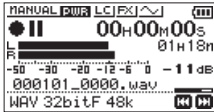

2. Press the PB CONT button.

The self-timer icon  appears with the time shown to the right on the recorder status screen.

Each time you press the PB CONT button, the setting changes as follows.

Time shown to the right of the icon

OFF (default) → 5S (5 seconds) → 10S (10 seconds)
→ OFF

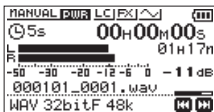

3. Set the time period, and press the RECORD [●] or ► button. Recording will start after the set time period.

NOTE

- When the set time is elapsing, the REC indicator blinks faster.
- The self-timer cannot be used when recording is paused.
- The self-timer function cannot be used when using the AUTO REC function.
- During overwrite recording, the self-timer cannot be used.

5-12. Using tone output

The tone output function can be used to automatically insert a tone signal whenever recording starts and stops. By connecting the Ω/LINE OUT jack on the left side of the unit and the external mic input jack of a digital SLR camera and using the auto tone function, the same tone signal will be recorded to files on both units. These tones can be used as guides when synchronizing the files in video editing software.

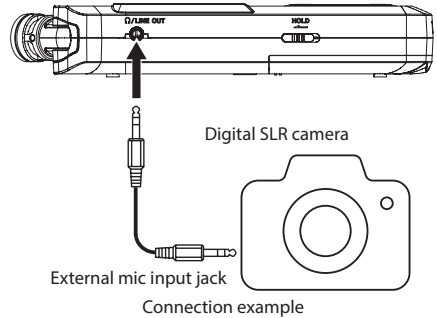

5. Recording

Setting the AUTO TONE

1. Press the MENU button to open the MENU Screen.

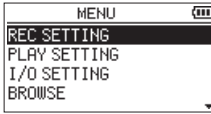

2. Use the + or – button to select the REC SETTING item, and press the ► button. The REC SETTING Screen opens.

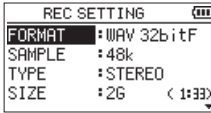

3. Use the + or – button to select the AUTO TONE item, and press the ►► or ► button.
4. Use the + or – buttons to set when tone signals are inserted.

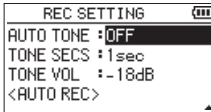

Options

OFF (default)

HEAD (recording start only)

HEAD+TAIL (recording start and stop)

5. After completing the setting, press the ◂/| (HOME) [■] button to return to the Home Screen.

CAUTION

- When recording is stopped by the AUTO REC function, no tone signal will be recorded when it stops.
- During overwrite recording, the automatic tone function cannot be used.

Setting the AUTO TONE length

You can set the length of the AUTO TONE.

1. Press the MENU button to open the MENU Screen.

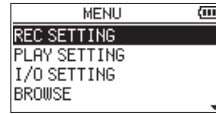

2. Use the + or – button to select the REC SETTING item, and press the ► button. The REC SETTING Screen opens.

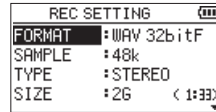

3. Use the + or – button to select the TONE SECS item, and press the ►► or ► button.
4. Use the + or – buttons to set the tone length.

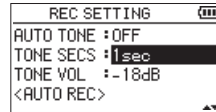

Options

0.5sec

1sec (default)

2sec

3sec

5. After completing the setting, press the ◂/| (HOME) [■] button to return to the Home Screen.

Adjusting the AUTO TONE volume

You can adjust the volume of the AUTO TONE.

1. Press the MENU button to open the MENU Screen.

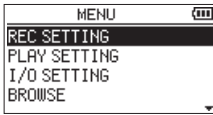

2. Use the + or – button to select the REC SETTING item, and press the ► button. The REC SETTING Screen opens.
3. Use the + or – button to select the TONE VOL item, and press the ►► or ► button.
4. Use the + and – buttons to adjust the tone volume.



Options

- 12dB
 - 18dB (default)
 - 24dB
 - 30dB
 - 36dB
5. After completing the setting, press the ϕ /I (HOME) [■] button to return to the Home Screen.

5. Recording

5-13. Recording duration

The table below shows the maximum recording time on microSD/microSDHC/microSDXC cards of different capacities and recording formats.

Recording format		microSD/microSDHC/microSDXC card capacity (hours:minutes)					
		2 GB	16 GB	32 GB	64 GB	128 GB	
WAV 16-bit (stereo)	44.1 kHz	3:05	24:40	49:20	98:40	197:20	
	48 kHz	2:50	22:40	45:20	90:40	181:20	
	96 kHz	1:25	11:20	22:40	45:20	90:40	
WAV 24-bit (stereo)	44.1 kHz	2:03	16:28	32:56	65:52	131:44	
	48 kHz	1:53	15:08	30:16	60:32	121:04	
	96 kHz	0:56	7:32	15:04	30:08	60:16	
WAV 32-bit float (stereo)	44.1 kHz	1:32	12:20	24:40	49:20	98:40	
	48 kHz	1:25	11:20	22:40	45:20	90:40	
	96 kHz	0:42	5:40	11:20	22:40	45:20	
MP3 (stereo/mono)	32 kbps	44.1/48 kHz	138:06	1104:48	2209:36	4419:12	8838:24
	64 kbps	44.1/48 kHz	69:03	552:24	1104:48	2209:36	4419:12
	96 kbps	44.1/48 kHz	42:02	368:16	736:32	1473:04	2946:08
	128 kbps	44.1/48 kHz	34:31	276:12	552:24	1104:48	2209:36
	192 kbps	44.1/48 kHz	23:01	184:08	368:16	736:32	1473:04
	256 kbps	44.1/48 kHz	17:15	138:04	276:08	552:16	1104:32
	320 kbps	44.1/48 kHz	13:48	110:28	220:56	441:52	883:44

- The recording times shown above are estimates. They might differ depending on the SD/SDHC/SDXC card in use.
- The recording times shown above are not continuous recording times, but rather they are the total possible recording times for the microSD/microSDHC/microSDXC card.
- If the recording time exceeds 24 hours, the unit will automatically continue recording in a new file.
- If recorded in mono in WAV files, the maximum recording time will be double the figures above.

6. Working with Files and Folders (Browse Screen)

On the Browse Screen, you can view the contents of the MUSIC Folder, which contains the audio files on the microSD card that you can use with the unit. On this screen, you can also play and erase selected audio files, create folders, add tracks to the playlist and so on. (see "Using the playlist" on page 64)

TIP

If you connect the unit with a computer by USB or mount the microSD card on a computer using a card reader or other input, you can use the computer to change the folder structure within the MUSIC folder and erase files as you would the contents of a hard drive. Furthermore, you can change file names from the computer.

6-1. Opening the Browse Screen

1. Press the MENU button to open the MENU Screen.

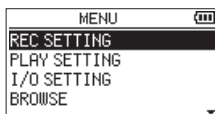

2. Use the + or – button to select the BROWSE item, and press the ► button.

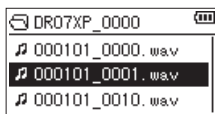

The contents of the folder that contains the file that was selected on the Home Screen before the Browse Screen was opened appears on the display.

6-2. Screen navigation

On the Browse Screen, folders and music files appear in a hierarchical structure much like they would appear on a computer. Only two levels of folders can be created.

- Use the + or – button to select files and folders.
- When a folder is selected, press the ►► button to show the contents of that folder.
- When a file or folder is selected, press the ◀◀ button to exit the currently open folder and go up a level in the folder structure.
- When a file or folder is selected, press the QUICK button to open the pop-up window.
- When a file is selected, press the ► button to return to the Home Screen and play the file. This folder that contains this file becomes the current folder, and new recorded file will be saved in this folder. If the playback area has been set to FOLDER, this folder becomes the new playback area.
- When a folder is selected, press the ► button to return to the Home Screen. The first file in the folder (shown at the top of the file list) will be played. This folder becomes the current folder, and new recorded files will be saved in this folder. Regardless of the previous setting, the playback area is set to FOLDER, and this folder becomes the new playback area.

6. Working with Files and Folders (Browse Screen)

6-3. Icons on the Browse Screen

The meanings of icons that appear on the Browse Screen are as follows.

Root Music Folder (MUSIC)

The MUSIC Folder is the highest (root) level folder in the hierarchy shown on the Browse Screen.

Audio file

The  icon appears before the names of music files.

Plus folder

This is a folder that contains subfolders.

Plain folder

This is a folder that does not contain subfolders.

Open folder ()

The contents of the folder marked with this icon currently appear on this screen.

6-4. File operations

Select the desired audio file on the Browse Screen and press the QUICK button to open the pop-up window that is shown below.



Use the + or – button to select the item you want from the following list and press ► button to execute it.

INFORMATION

Information (date/time, size) about the selected file appears.

Press the ◀◀ button to return to the Browse Screen.

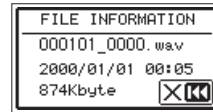

ADD PLAYLIST

Adds the selected file to the playlist. (see "Using the playlist" on page 64)

DELETE

A message appears to confirm that you want to delete the file.

To delete the file, press the ►► button. To cancel deletion, press the ◀◀ button.



NOTE

The pop-up menu can also be closed by pressing the QUICK button.

6. Working with Files and Folders (Browse Screen)

6-5. Folder operations

Select the desired folder on the Browse Screen and press the QUICK button to open the pop-up window that is shown below.



Use the + or – button to select the item you want from the following list and press ► button to execute it.

SELECT

Returns to the Home Screen and selects the first file in the folder. Regardless of the previous setting, the playback area is set to FOLDER, and this folder becomes the new playback area. When recording, files are created in this folder.

ALL DEL

A pop-up message appears to confirm that you want to delete all the files in the selected folder at once. To delete the file, press the ►► button. To cancel deletion, press the ◀◀ button.



FOLDER DELETE

A pop-up message appears to confirm immediate deletion of the selected folder and all files in it. Press the ►► button to delete the folder and all files in it. Press the ◀◀ button to cancel deletion.

NOTE

- You cannot erase read-only files and files that are not recognized by this unit.
- The pop-up menu can also be closed by pressing the QUICK button.

6-6. Creating a new folder

1. Use the + and – buttons to select NEW FOLDER, which appears at the bottom of the folder list.

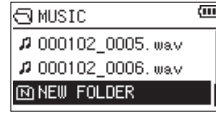

2. Press the ► button. It shows a message to confirm creation of a new folder.



3. Press the ►► button to create a new folder or press the ◀◀ button to cancel.

A newly created folder becomes the current folder (currently selected folder), and recorded files are saved in this folder. If the playback area has been set to FOLDER, this folder becomes the playback area.

NOTE

Since this unit supports only a two-level folder structure, the NEW FOLDER function is not available in second-level folders.

7. Playback

On the Home Screen, you can use the **◀◀** and **▶▶** buttons to select the playback track. The files that you can select are determined by the playback area setting. Limiting the playback area makes track selection easier when you have numerous recorded and copied tracks on the microSD card. On the PLAY SETTING Screen, you can select all files, the current folder or the playlist as the playback area. You can also use the Browse Screen to set a folder as the playback area.

NOTE

On the Browse Screen, regardless of the playback area setting, you can select any file on the microSD card that you want.

7-1. Adjusting the playback volume

The volume of output through the built-in speaker or the Ω /LINE OUT connector can be adjusted using the + or – button while the Home Screen is open.

A pull-up volume indicator appears.

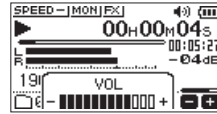

7-2. Setting the playback area (AREA)

Set the playback area for repeat and ordinary playback on the PLAY SETTING Screen.

1. Press the MENU button to open the MENU Screen.

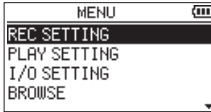

2. Use the + or – button to select the PLAY SETTING item, and press the ► button. This opens the PLAY SETTING Screen.

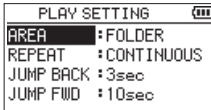

3. Use the + or – button to select the AREA item, and press the ►► or ► button.

4. Use the + or – button to set the playback area.

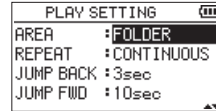

Options

ALL FILES

Set the playback area as all files in the Music Folder on the microSD card.

FOLDER (default)

Set the playback area as all the files in the currently selected folder.

PLAYLIST

Set the playback area as the files in the playlist. (see "Using microSD cards" on page 8)
If there is no playlist defined, a No PLAYLIST pop-up appears.



5. After completing the setting, press the ◂/1 (HOME) [■] button to return to the Home Screen.

The current playback area setting appears in the lower left of the Home Screen.

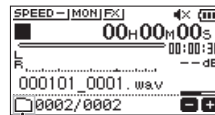

Playback area indication

7. Playback

7-3. Selecting a folder for the playback area (1)

Regardless of the current playback area, if you select a folder on the Browse Screen, the playback area changes to the selected folder.

1. Press the MENU button to open the MENU Screen.

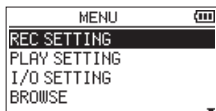

2. Use the + or – button to select the BROWSE item, and press the ► button.
The Browse Screen will open.

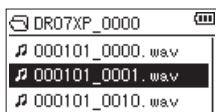

The content of the folder that contains the file selected on the Home Screen is displayed.

3. Use the ◀◀ or ▶▶ button to select a folder level, and use the + or – button to select a folder.

NOTE

For an explanation of how to use the Browse Screen, see "Working with Files and Folders (Browse Screen)" on page 57.

4. Press the QUICK button to open the following pop-up window.



5. Use the + or – button to select the SELECT item, and press the ► button.

The Home Screen reopens with the first file in the folder selected, and the unit is stopped.

Regardless of the previous setting, the playback area is set to FOLDER, and this folder becomes the playback area. This folder becomes the current folder, and new recorded files will be saved in this folder.

7-4. Selecting a folder for the playback area (2)

When the playback area is set to FOLDER, if you select a file on the Browse Screen, the folder that contains the selected file becomes the playback area.

1. Press the MENU button to open the MENU Screen.

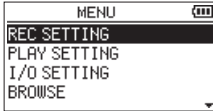

2. Use the + or – button to select the BROWSE item, and press the ► button. The Browse Screen will open.

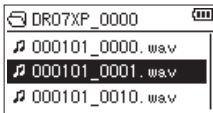

The content of the folder that contains the file selected on the Home Screen is displayed.

3. Use the ◀◀ or ▶▶ button to select a folder level, and use the + or – button to select the folder that contains the track (file) you want to play.

NOTE

For an explanation of how to use the Browse Screen, see "Working with Files and Folders (Browse Screen)" on page 57.

4. Press the ▶▶ button.

5. Use the + or – button to select the desired file.

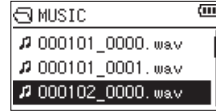

6. Press the ► button.

The display returns to the Home Screen, and the selected track starts playing. This folder becomes the current folder, and new recorded files will be saved in this folder.

In addition, the folder that contains this file becomes the playback area regardless of the playback area folder set previously.

7. Playback

7-5. Using the playlist

You can make a list of files for playback (playlist).

On the PLAY SETTING Screen if you select PLAYLIST for the AREA item, you can set playback to just the tracks in your playlist.

Adding files to the playlist

1. Press the MENU button to open the MENU Screen.

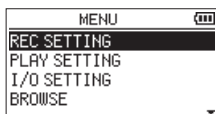

2. Use the + or – button to select the BROWSE item, and press the ► button. The Browse Screen will open.

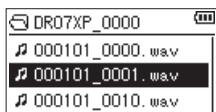

The content of the folder that contains the file selected on the Home Screen is displayed.

NOTE

For an explanation of how to use the Browse Screen, see "Working with Files and Folders (Browse Screen)" on page 57.

3. Use the + or – button to select the file you want to add to the playlist, and press the QUICK button. A pop-up window appears.

NOTE

For details about how to select the file, see "Working with Files and Folders (Browse Screen)" on page 57.

4. Use the + or – button to select ADD LIST.



5. Press the ► button. The track is added to the playlist and the popup window closes.
6. Repeat steps 3, 4, and 5 as necessary to add more tracks to the playlist. The tracks are numbered in the order that they are added.

Editing the playlist

You can view and edit the playlist you have made on the PLAYLIST Screen. You can also use this screen to play tracks and to edit the playlist.

1. Press the MENU button to open the MENU Screen.

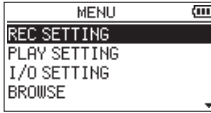

2. Use the + or – button to select the BROWSE item, and press the ► button. The Browse Screen will open.

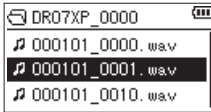

The content of the folder that contains the file selected on the Home Screen is displayed.

3. Use the ◀◀ button to move to the top folder level.



4. Use the + or – button to select the PLAYLIST item, and press the ►► button. This opens the PLAYLIST Screen.



5. Use the + or – button to select the file you want to edit and press the QUICK button. A pop-up window appears.



6. Use the + or – button to select the item you want from the following list and press ► button to execute it.

MOVE

Select this to change the order of tracks in the playlist. In addition to the file name, the track number also appears highlighted in inverse.

- 1) Use the + or – button to move the selected track to a different position in the playlist.

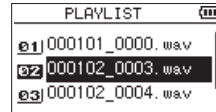

In the above example, the 4th track has been moved to the 3rd track position.

- 2) Press the ► button.

This completes movement and reopens the PLAYLIST Screen.

DELETE

Remove the selected track from the playlist. The file is removed from the playlist, but it is not erased from the microSD card.

ALL CLEAR

A confirmation message appears to confirm that you want to remove all the files from the playlist. Press the ►► button to clear the files. Press the ◀◀ button to cancel removal.

For this operation, it does not matter which track you select in step 3. All the files are removed from the playlist, but they are not erased from the microSD card.



7. Playback

7-6. Selecting files for playback (skipping)

When the Home Screen is open, use the ◀◀ and ▶▶ buttons to select the file for playback.

If you press the ◀◀ button when the playback position is located at the middle of a file, it will return to the beginning of that file. If you press the ◀◀ button when located at the beginning of a file, the playback position will skip to the beginning of the previous file.

If you press the ▶▶ button when located at the beginning of or middle of a file, the playback position will skip to the beginning of the next file.

NOTE

- Files in the playback area can be played.
- The track name, file number and other file information for the currently playing file appear on the display.
- When the IN and OUT points are set between the current position and the end of the track, pressing this button skips to those points. Use the ◀◀ and ▶▶ buttons if you want to move between songs

7-7. Playing recordings

When the Home Screen is open and playback is stopped, press the ▶ button to start playback.

NOTE

- Files in the playback area can be played.
- You can also choose files for playback by name on the Browse Screen.

Pausing

When the Home Screen is open and a file is playing back, press the ⏪/⏩ (HOME) [■] button to pause playback at the current position.

Press the ▶ button again to restart playback from that position.

Stopping

When the Home Screen is open and a file is playing back, press the ⏪/⏩ (HOME) [■] button to pause playback. Press the ⏪/⏩ (HOME) [■] button again to return to the beginning of the file.

Searching backward and forward

When the Home Screen is open and a file is playing back or stopped, press and hold the ◀◀ or ▶▶ button to search the playback file backward or forward.

NOTE

Press and hold the ◀◀ or ▶▶ button to accelerate the search speed.

7-8. Repeat playback (REPEAT)

You can repeatedly play one file or multiple files within a designated area.

1. Press the MENU button to open the MENU Screen.

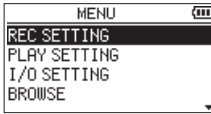

2. Use the + or – button to select the PLAY SETTING item, and press the ► button. This opens the PLAY SETTING Screen.

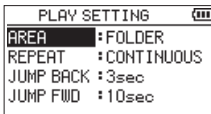

3. Use the + or – button to select the REPEAT item, and press the ►| or ► button.

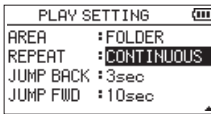

4. Use the + or – button to select a repeat mode.

Options

CONTINUOUS (default)

All files in the playback area are played in sequence one time. (This setting is the ordinary playback mode.)

SINGLE

The selected track is played once without repeating.

The icon appears on the Home Screen.

1 REPEAT

The current file is played repeatedly.

The icon appears on the Home Screen.

ALL REPEAT

All files in the selected playback area are played back repeatedly.

The icon appears on the Home Screen.

NOTE

If you start loop playback, the repeat operation automatically switches to CONTINUOUS if it is in SINGLE, 1 REPEAT, or ALL REPEAT mode.

5. After completing the setting, press the ◂/1 (HOME) [■] button to return to the Home Screen and start playback.

7. Playback

7-9. Special playback control functions

The unit has some special playback control functions.

For example, you can playback a selected section of a file repeatedly or change the tempo of music without changing the pitch. You can also enhance the perceived overall sound pressure for comfortable listening when the playback sound is difficult to hear.

These playback control functions enable effective practice and analysis of musical passages.

Playback Control Screen

Use the Playback Control Screen to set the playback control functions.

While the Home Screen is open when stopped or playing back, press the PB CONT button to open the Playback Control Screen.

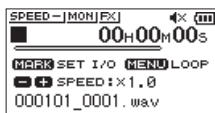

This screen can be used to make settings for the playback speed and loop playback.

After you finish making settings on this screen, press the ϕ /I (HOME) [■] or PB CONT button to return to the Home Screen.

Loop playback of a selection

With this function, you can continuously repeat (loop) the playback of a selection that you make.

1. While the Home Screen is open when stopped or playing back, press the PB CONT button to open the Playback Control Screen.

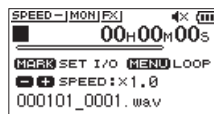

2. Press the ► button to start playback, and press the MARK button at the start point of the section that you want to play repeatedly.

This position is set as the IN (start) point.



3. Press the MARK button at the end point of the section that you want to play repeatedly.

This position is set as the OUT (end) point, and loop playback of the section between the IN and OUT points starts.



During loop playback the ϕ I/O indicator also appears.

4. Press the PB CONT button to return to the Home Screen while maintaining the IN (start) and OUT (end) point and loop settings.

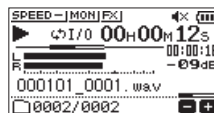

NOTE

- The I/O Too Short pop-up message appears if the section between the IN and OUT points is too short. Set them again. The section should be 1 second or longer.
- Press the MARK button again to clear the IN and OUT points.
- To stop loop playback, press the MENU button when the Playback Control Screen is open. Press the MENU button again to start loop playback between the set IN and OUT points.
- You cannot set the IN and OUT points in different files.
- The previous IN and OUT point settings are lost when you set the IN point on a different file.
- Accurate assignment of IN and OUT points is not always possible for variable bit rate (VBR) MP3 files.

Changing the playback speed (VSA)

This unit has a built-in variable speed audition (VSA) function to change the playback speed without changing its pitch.

NOTE

The VSA function will not work when you select a file recorded with a sampling rate of 96 kHz. At this time, **SPEED X** will appear on the Home Screen. However, the playback speed can be changed. Even though it will not affect this file, the playback speed adjustment will become effective when a 44.1/48 kHz file is selected using the **◀◀** or **▶▶** button on the Home Screen.

When the Playback Control Screen is open, press the + or – button to increase or decrease the playback speed.

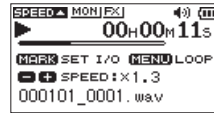

The VSA function can change the playback speed in the range from 0.5 (50%) to 2.0 (200%) times (in 0.1 increments) the normal speed.

Press the PB CONT button to return to the Home Screen while maintaining the set playback speed.

The **SPEED ▲** or **SPEED ▼** icon appears if the playback speed is set to a value larger or smaller than 1.0, respectively.

7. Playback

7-10. Setting the playback equalizer

You can choose from different sound equalization settings to enhance listenability (PLAYEQ). Use the PLAYEQ item on the I/O SETTING Screen or the Quick menu to set the playback equalization.

Operation from the MENU Screen

1. Press the MENU button to open the MENU Screen.

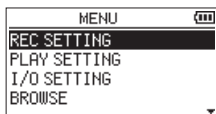

2. Use the + or – button to select the I/O SETTING item, and press the ► button. The I/O SETTING Screen will open.

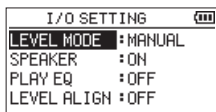

3. Use the + or – button to select the PLAYEQ item, and press the ► button.
4. Use the + and – buttons to adjust the playback equalization. TREBLE, MIDDLE, and BASS indicate that adjustment in the high, middle, or low frequency range is enabled, and + and – indicate that the sound level in that range is increased or decreased, respectively.

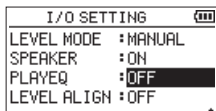

Options

OFF (default)

TREBLE +

TREBLE –

MIDDLE +

MIDDLE –

BASS +

BASS –

5. After completing the setting, press the ◀/1 (HOME) [■] button to return to the Home Screen.

Operation from the Quick menu

1. During playback when the Home Screen is open, press the QUICK button to open the Quick menu.



2. Use the + or – button to select the PLAYEQ item, and press the ► button. This opens the PLAYEQ Setting Screen.

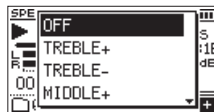

Options

OFF (default)

TREBLE +

TREBLE –

MIDDLE +

MIDDLE –

BASS +

BASS –

3. Use the + or – button to select a setting, and press the ► button to enable it and return to the Home Screen.

7-11. Increasing the perceived overall sound pressure to enhance listenability (LEVEL ALIGN)

If the playback sound is very small and indiscernible, the perceived overall sound pressure can be increased to enhance listenability.

Operation from the MENU Screen

1. Press the MENU button to open the MENU Screen.

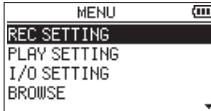

2. Use the + or – button to select the I/O SETTING item, and press the ► button. The I/O SETTING Screen will open.

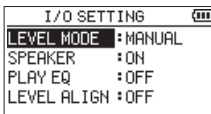

3. Use the + or – button to select the LEVEL ALIGN item, and press the ► button.
4. Use the + and – buttons to set the LEVEL ALIGN function.

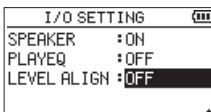

Options

OFF (default)

ON

5. After completing the setting, press the ◀/I (HOME) [■] button to return to the Home Screen.

Operation from the Quick menu

1. During playback when the Home Screen is open, press the QUICK button to open the Quick menu.



2. Use the + or – button to select the LEVEL ALIGN item, and press the ► button.
3. A screen to enable/disable the level alignment function appears.

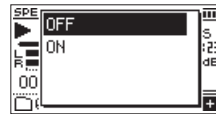

4. Use the + or – button to select ON, and press the ► button to enable the level alignment function. Select OFF and press the ► button to disable the level alignment function.

NOTE

The level alignment function might not have much effect depending on the source of the sound (for example, a music file that has already had sound pressure adjusted).

7. Playback

7-12. Using the jump function

During playback, you can jump backward or forward from the current playback position by a set amount of time.

The same playback status will be retained after jumping.

The jump forward function can only be used during dictation playback mode, overwrite recording mode and with the file division function. Operation differs in these modes.

Use the JUMP BACK and JUMP FWD settings to set the backward and forward times.

	JUMP BACK	JUMP FWD
Options	OFF	OFF
	1sec	1sec
	3sec (default)	3sec
	5sec	5sec
	10sec	10sec (default)
	30sec	30sec
	1min	1min
	5min	5min
	10min	10min

Operation when not using dictation playback mode, overwrite recording mode or the file division function

Jump back

During playback, press the ► button to jump back from the current position by the set JUMP BACK time.

Operation when using dictation playback mode, overwrite recording mode or the file division function

Jump back

During playback, press the ► button to jump back from the current position by the set JUMP BACK time.

Jump forward

During playback, press the ►► button to jump forward from the current position by the set JUMP FWD time.

NOTE

When jumping back, if the amount of time from the current playback position to the beginning of the file is less than the set JUMP BACK time, playback will jump to the beginning of the file. When jumping forward, if the amount of time from the current playback position to the end of the file is less than the set JUMP FWD time, playback will jump to the end of the file and pause.

Setting the jump back time

Operation from the MENU Screen

1. Press the MENU button to open the MENU Screen.

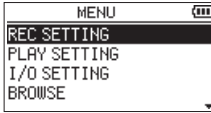

2. Use the + or – button to select the PLAY SETTING item, and press the ► button. This opens the PLAY SETTING Screen.

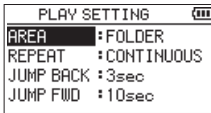

3. Use the + or – button to select the JUMP BACK item, and press the ► button.
4. Use the + and – buttons to set the jump back time.

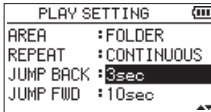

Options

- OFF
- 1sec
- 3sec (default)
- 5sec
- 10sec
- 30sec
- 1min
- 5min
- 10min

5. After completing the setting, press the ◀/I (HOME) [■] button to return to the Home Screen.

NOTE

If the amount of time to the beginning of the file is less than the set time, playback will jump to the beginning of the file and continue playing or pause.

Operation from the Quick menu

1. Switch the operation mode of the unit to dictation playback mode. (see "Enabling DICTATION PLAY mode" on page 79)
2. During playback when in dictation playback mode, press the QUICK button to open the Quick menu.



3. Use the + or – button to select the JUMP BACK item, and press the ► button. The JUMP BACK Time Setting Screen will open.

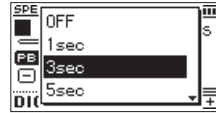

4. Use the + or – button to select a setting, and press the ► button to enable it and return to the Home Screen.

7. Playback

Setting the jump forward time

Operation from the MENU Screen

1. Press the MENU button to open the MENU Screen.

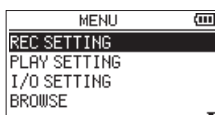

2. Use the + or – button to select the PLAY SETTING item, and press the ► button. This opens the PLAY SETTING Screen.

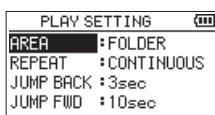

3. Use the + or – button to select the JUMP FWD item, and press the ► button.
4. Use the + and – buttons to set the jump forward time.



Options

OFF

1sec

3sec

5sec

10sec (default)

30sec

1min

5min

10min

5. After completing the setting, press the ϕ /I (HOME) [■] button to return to the Home Screen.

Operation from the Quick menu

1. During playback when in dictation playback mode, press the QUICK button to open the Quick menu.

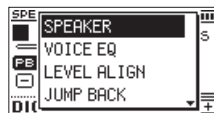

2. Use the + or – button to select the JUMP FWD item, and press the ► button. The JUMP FWD Time Setting Screen will open.



3. Use the + or – button to select a setting, and press the ► button to enable it and return to the Home Screen.

NOTE

If the amount of time to the end of the file is less than the set time, playback will jump to the end of the file and pause.

8. Quick Operations

8-1. Features of the QUICK button

The QUICK button can be used for the following functions.

The functions of the QUICK button for different screens and states are as follows.

Screen	State	Menu item	Action	Reference
Home Screen	Stopped/ paused	DELETE	Delete the current file.	see page 76
		DIVIDE	Divide the current file.	see page 77
		OVERWRITE	Record over (overwrite) the current file.	see page 78
		DICTIONATION PLAY	Enable dictation playback mode.	see page 79
	During playback	SPEAKER	Turn the built-in speaker on/off.	see page 34
		PLAYEQ	Set playback equalization.	see page 70
		LEVEL ALIGN	Increase the perceived overall sound pressure to enhance listenability.	see page 71
	Recording standby	LEVEL MODE	Set the LEVEL MODE function. This will not be shown when using 32-bit float.	see page 44
		LOW CUT	Set the low-cut filter.	see page 41
MIC LR SWAP		Set mic left/right reversal.	see page 37	
Home Screen DICTIONATION PLAY mode	SPEAKER	Turn the built-in speaker on/off.	see page 34	
	VOICE EQ	This function enhances the vocal frequency range to make voices easier to hear in the playback sound.	see page 79	
	LEVEL ALIGN	Increase the perceived overall sound pressure to enhance listenability.	see page 71	
	JUMP BACK	Set the jump back time.	see page 73	
	JUMP FWD	Set the jump forward time.	see page 74	
	MODE EXIT	Exit DICTIONATION PLAY mode.	see page 79	
Playback Control Screen	SPEAKER	Turn the built-in speaker on/off.	see page 34	
	PLAYEQ	Set playback equalization.	see page 70	
	LEVEL ALIGN	Increase the perceived overall sound pressure to enhance listenability.	see page 71	
Browse Screen	When file selected	FILE INFORMATION	Show file information for the selected file.	see page 58
		ADD PLAYLIST	Add the selected file to the playlist.	
		DELETE	Delete the selected file.	
	When folder selected	SELECT	Select the first file in the selected folder.	see page 59
		ALL DELETE	Deletes all files in the selected folder.	
		FOLDER DELETE	Delete the selected folder and all files in it.	
PLAYLIST Screen	MOVE	Change the order of files that have been added to the playlist.	see page 65	
	DELETE	Remove a file that has been added to the playlist.		
	ALL CLEAR	Remove all files that have been added to the playlist.		
TUNER Setting Screen			Switches between CALIB and INPUT LEVEL items	see page 87
Overwrite recording mode	TO EDIT POINT	Move to where overwrite recording started.	see page 78	
	UNDO	Restore to state before most recent overwrite recording.	see page 78	
	MODE EXIT	Exit OVERWRITE mode.	see page 78	

8. Quick Operations

8-2. Quick menu

Press the QUICK button to open the Quick menu for use. The content of the Quick menu differs according to the recorder status and operation mode.

Press the QUICK or $\phi/1$ (HOME) [■] button to close the Quick menu.



Quick menu when playback is stopped or paused

8-3. Deleting files

The currently selected file can be deleted without using the Browse Screen.

1. To delete a file, select it using the $\blacktriangleleft\blacktriangleleft$ or $\blacktriangleright\blacktriangleright$ button or the Browse Screen.
2. While the Home Screen is open when stopped, press the QUICK button to open the Quick menu.



3. Use the + or – button to select DELETE.
4. Press the \blacktriangleright button to open a confirmation screen for file deletion.



5. To delete the file, press the $\blacktriangleright\blacktriangleright$ button. To cancel deletion, press the $\blacktriangleleft\blacktriangleleft$ button.

8-4. Dividing the selected file (DIVIDE)

A recorded file can be divided into two at a specified position.

1. Select a file to be divided using the **I◀◀** or **▶▶I** button or the Browse Screen.
2. While the Home Screen is open when stopped, press the QUICK button to open the Quick menu.



3. Use the + or – button to select the DIVIDE item, and press the **▶** button. The DIVIDE Screen will open.

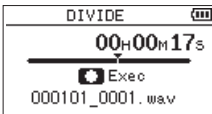

4. Use the + or – button to specify the position for file division, and press the RECORD [●] button. The following pop-up window appears.



5. Press the **▶▶I** button to divide the file. If you press the **I◀◀** button, the file will not be divided and the DIVIDE Screen will reopen.

NOTE

- When the DIVIDE Screen is open, you can press the **▶** button and set the divide position while playing the track.
- When the DIVIDE Screen is open, press the **▶** button to start/pause playback and press the **I◀◀/▶▶I** button to move to the beginning/end of the track. Adjust the position for file division using the + or – button. Press and hold the + or – button to move the position continuously.
- After dividing a file, two new files with “_a” and “_b” added to the end of the original file name are created.

Examples

File name before division

000101_0001.wav

File names after division

000101_0001_a.wav (part before division point)

000101_0001_b.wav (part after division point)

CAUTION

- MP3 files cannot be divided.
- If the microSD card has insufficient open space, division might not be possible.
- Division is not possible if the file name would become more than 200 characters long.
- Division is not possible if the name that would be given to a new file is the same as the name of an existing file.

TIP

Add marks during recording at positions where you want to divide a file. By opening the DIVIDE Screen after moving to a mark, you can divide at its position. (see "Adding marks manually" on page 84)

8. Quick Operations

8-5. Overwrite recording

A recorded file can be overwritten from a desired position.

Selecting a file to overwrite record

On the Browse Screen, select the file to overwrite record.

NOTE

File skipping cannot be used to select files in overwrite recording mode.

Activating overwrite recording mode

1. While the Home Screen is open when stopped, press the QUICK button to open the Quick menu.



2. Use the + or - button to select the OVERWRITE item, and press the ► button. This will activate overwrite recording mode.

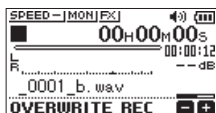

3. Use the ◀◀, ▶▶ and ► buttons to stop at the position where you want to start overwrite recording. At this time, using the ◀◀ or ▶▶ button will jump. (see "Using the jump function" on page 72)

Conducting overwrite recording

1. Press the RECORD [●] button. The following pop-up window appears.



Press the ►► button to close the pop-up window and start recording standby.

2. Press the RECORD [●] button again to start overwrite recording.
3. Press the ◻/I (HOME) [■] button to stop overwrite recording. After stopping recording, the unit will return to the overwrite recording starting point and stop.

Checking the result of recording

Play the recorded file to check it.

NOTE

To return to the starting point of overwrite recording, you can select TO EDIT POINT from the Quick menu.

Undoing and redoing

In overwrite recording mode, you can undo an overwrite recording once to return to the immediately previous state. You can also restore (REDO) an undone change.

CAUTION

- Overwrite recording does not change the file name.
- Overwrite recording can be done as many times as you like, but only the file before the most recent overwritten recording will be retained. Overwriting again will delete the earlier file.

Ending overwrite recording mode

When the Home Screen is open and the unit is stopped, use the Quick menu to select MODE EXIT, and press the ► button.

This ends overwrite recording mode.

CAUTION

Ending overwrite recording mode will delete any file available for UNDO (REDO) operations.

8-6. Transcribing recorded files (DICTATION PLAY)

The DICTATION PLAY mode allows you to search for the parts of the selected file that you want to hear during playback, making it useful for transcribing meeting minutes, for example. In DICTATION PLAY mode, the file skip function is disabled to prevent accidentally moving to the previous or next file. Select the file before enabling DICTATION PLAY Mode.

Enabling DICTATION PLAY mode

1. While the Home Screen is open when stopped, press the QUICK button to open the Quick menu.



2. Use the + or – button to select the DICTATION PLAY item, and press the ► button. This will activate DICTATION PLAY mode.

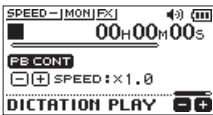

NOTE

- Recording is not possible in DICTATION PLAY mode.
- Menu operations are not possible in DICTATION PLAY mode.
- To use a menu, exit DICTATION PLAY mode temporarily.

Adjusting the playback equalization

Using the Quick menu, you can make the audio easier to hear.

VOICE EQ

This makes the vocal frequency range easier to hear.

LEVEL ALIGN

The overall sound pressure is increased to enhance listenability.

Changing the playback position

Press ◀◀ briefly: jump back

Press ▶▶ briefly: jump forward

NOTE

You can set the jump back and jump forward times from the Quick menu when stopped.

Changing the playback volume and speed

Press the PB CONT button to switch between changing the volume and speed of playback.

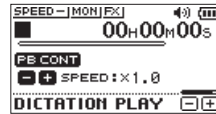

Playback speed adjustment mode

Use the + and – buttons to change the playback volume/speed.

8. Quick Operations

Exiting DICTATION PLAY mode

1. While the Home Screen is open when stopped, press the QUICK button to open the Quick menu.



2. Use the + or – button to select the MODE EXIT item, and press the ► button. This exits DICTATION PLAY mode.

NOTE

- Recording is not possible in DICTATION PLAY mode.
- Menu operations are not possible in DICTATION PLAY mode.
- To use a menu, exit DICTATION PLAY mode temporarily.

9. Timer recording functions

The unit can turn itself on as well as start and stop recording at set times.

Make date and time, recording level and other recording settings before using the timer recording functions.

NOTE

When timer recording is enabled, the following functions are disabled.

- Auto recording
- Pre-recording
- Auto tone
- Automatic power saving

9-1. Setting times for timer recording

1. Press the MENU button to open the MENU Screen.

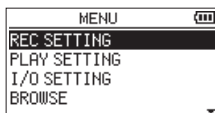

2. Use the + or – button to select the TIMER REC item, and press the ► button. The TIMER REC Screen will open.

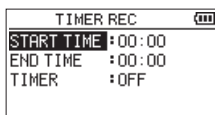

3. Use the + and – buttons to select START TIME or END TIME, and press the ►► or ► button.

An  will appear to the right of the time being set.

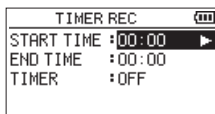

4. Press the ► button to open the time setting screen.



START TIME Screen

5. Use the ◀◀ and ▶▶ buttons to move the cursor, and use the + and – buttons to change the hour and minute.
6. After making the setting, press the ► button to confirm.

CAUTION

Always press the ► button to confirm the setting. Pressing the MENU or ◀/1 (HOME) [■] button will discard the changes.

NOTE

- The time is displayed in 24-hour format.
- A setting of no time, which is shown as --:-- can be set by setting the start or end time on a time setting screen to a value higher than 23.

If no start time is set	Recording will start as soon as timer recording is executed.
If no stop time is set	Recording will continue until the microSD card is full or the batteries die.

9. Timer recording functions

9-2. Turning on the timer recording function

1. Press the MENU button to open the MENU Screen.

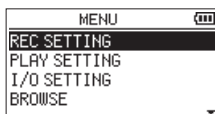

2. Use the + or – button to select the TIMER REC item, and press the ► button. The TIMER REC Screen will open.

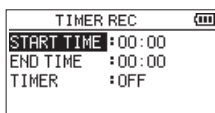

3. Use the + or – button to select the TIMER item, and press the ►► or ► button.

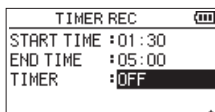

4. Use the + or – button to select the function. When the setting is being changed, ▣ appears to the right of the setting option.

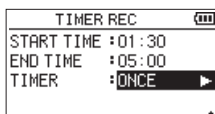

Option	Meaning
OFF	Timer recording is disabled.
ONCE	Timer recording will occur once at the specified time.
DAILY	Timer recording will occur every day at the specified time.

NOTE

- If either the START TIME or STOP TIME is left unset, the options available will be OFF and ONCE.
- Timer recording is not possible if neither the START TIME nor the STOP TIME is set (--- shown).

5. Press the ► button again to open a confirmation message.



6. Press the ►► button to set timer recording and shut down the unit.

NOTE

If the START TIME has not been set, recording will start immediately.

The unit will turn on and recording will start at the set time. During timer recording, **TIMER REC** appears on the screen.

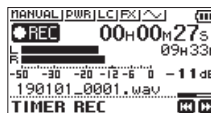

Recording will stop and the unit will turn off at the set time.

NOTE

- If the HOLD switch is set in the direction of the arrow, disable the hold function before operating.
- The START TIME and STOP TIME settings are retained after timer recording completes. The START TIME and STOP TIME settings are also retained when timer recording is canceled.

Canceling timer recording when in standby

Press the \mathcal{O}/I (HOME) [■] button to turn the power on and open a confirmation message.



Press the $\blacktriangleright\blacktriangleright$ button to cancel timer recording and return to the Home Screen. Canceling will set timer recording to OFF.

Canceling scheduled recordings during timer recording

Press the \mathcal{O}/I (HOME) [■] button to open a confirmation message.



Press the $\blacktriangleright\blacktriangleright$ button to cancel timer recording and return to the Home Screen. Canceling will set timer recording to OFF.

10. Mark functions

10-1. Adding marks manually

When playing, recording or in recording standby, press the MARK button to add a mark at any point.

When a mark is added, a pull-up appears at the bottom of the display.

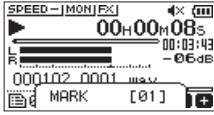

NOTE

- Mark information is stored in the file with numbers between 01–99. The maximum number of marks in a file is 99.
- Since the unit is compatible with BWF format WAV files, marks added to a WAV file during recording are stored in it. Marks stored in the file are available when playing back the file using BWF-compatible software, for example.

10-2. Adding marks automatically to a recording

This function allows the unit to add marks automatically using AUTO REC.

On the REC SETTING Screen, set the AUTO REC MODE to MARK.

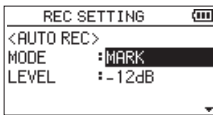

For details, see "Recording automatically (AUTO REC)" on page 50.

10-3. Moving to mark positions

When stopped, paused or playing back, press the ◀◀ or ▶▶ button while pressing the MARK button to move (skip) to the previous or next mark in the selected file.

You can use this function to go to the beginning of a song, similar to an index.

NOTE

You cannot move to a cue mark of a different file.

10-4. Clearing marks

When stopped or paused, move to a mark. Then, press the MARK button to clear that mark.

11. Using the effects

This unit has built-in effects.

Effects can be applied to the input signal during recording and practice as well as to the signal during playback.

When an effect is on, the **FX** icon appears as light letters on a dark background (**FX**) at the top of the Home Screen.

Effects ON indication

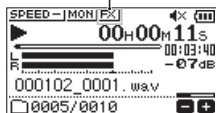

11-1. Setting the effect

1. Press the MENU button to open the MENU Screen.

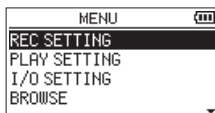

2. Use the + or – button to select OTHERS item, and press the ► button.
The OTHERS Screen opens.

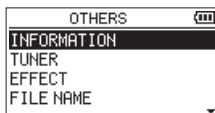

3. Use the + or – button to select the EFFECT item, and press the ► button.
The EFFECT Screen will open.

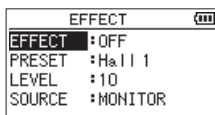

As shown in the above illustration, there are four setting items on the EFFECT Screen.

Use the ◀◀ or ▶▶ button and the + or – button to set each item.

EFFECT

Use this to turn the effect on or off.
(Default: OFF)

PRESET

Select the preset for the effect being used. See the "Effects Preset List" on page 85 for details about the preset effects.

LEVEL

Use this to change the output level of the preset effect selected in the PRESET item. Setting range: 0–20
(Default: 10)

SOURCE

Use this to set whether the effect is applied to the input signal (INPUT) or the output signal (MONITOR).
(Default: MONITOR)

4. Use the + and – buttons to select the desired item, and press the ▶▶ or ► button.
5. Use the + or – button to set the desired value.
6. Press the ◀◀ button when you are done making the setting to return to item selection status.
7. After completing the setting, press the ◀/1 (HOME) [■] button to return to the Home Screen.

CAUTION

When the sampling frequency is set to 96 kHz, or a WAV file with a sampling frequency of 96 kHz is played, the built-in effects do not work. However, you can still set the built-in effects.

Effects Preset List

Preset name	Effects
Hall 1 (Default)	This is a bright reverb modeled after a large hall-like space.
Hall 2	This is a warm reverb modeled after a large hall-like space.
Room	This reverb is modeled on a small indoor space.
Studio	This reverb is modeled on a studio-like space.
Plate 1	This is a bright plate reverb.
Plate 2	This is a warm plate reverb.

12. Tuning an instrument

This unit has a built-in tuner. By inputting sound from a musical instrument, you can tune it accurately while viewing the tuning meter shown in the display.

12-1. Using the tuner

Setting the tuner

1. Press the MENU button to open the MENU Screen.

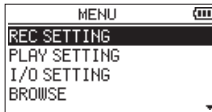

2. Use the + or - button to select OTHERS item, and press the ► button.

The OTHERS Screen opens.

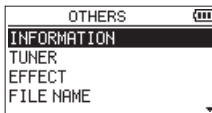

3. Use the + or - button to select the TUNER item, and press the ► button.

The TUNER Setting Screen will open.

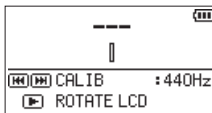

The TUNER Setting Screen contains a CALIB option to set the frequency of A.

Press the ◀◀ or ▶▶ button to decrease or increase the fundamental frequency.

Setting range: 435Hz - 445Hz

(in 1 Hz increments, default: 440Hz)

NOTE

When the TUNER Setting Screen is open, press the ► button to reverse the screen orientation.

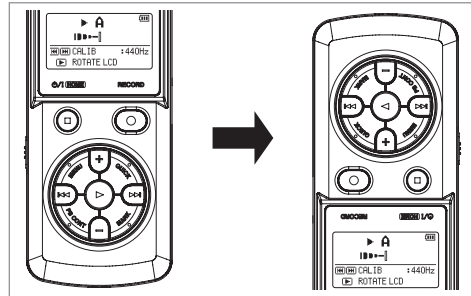

Tuning a musical instrument

1. Open the TUNER Setting Screen, and sound a note near the unit.
The closest pitch name will be shown above the center of the meter.
2. Tune the instrument so that the target pitch name appears and the center of the tuner lights.
A bar appears to the left or right of center if the sound is lower or higher than the target pitch. The bar becomes longer the more the input pitch differs from the target pitch.

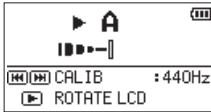

Adjusting the input level for tuning

1. When the TUNER Setting Screen is open, press the QUICK button.
The CALIB item at the bottom of the screen will be replaced with an INPUT LEVEL item.
2. Use the ◀◀ or ▶▶ button to adjust the input level.
During adjustment, a pull-up with meters showing the input level will appear at the bottom of the display.
Adjustment is the same as explained in (see "Adjusting the input level" on page 49).

13. USB connection

By connecting this unit with a computer using a USB cable, you can power the unit with USB bus power, and use the unit as an SD card reader and as a USB audio interface.

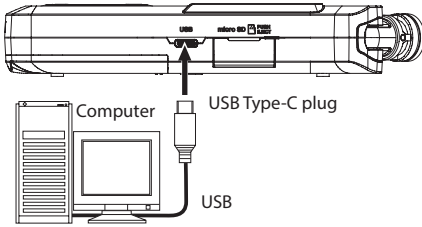

When the unit is on

When operating on batteries, if you connect the computer and the unit with a USB cable, the unit will be powered from its USB port (USB bus power is used first).

NOTE

The same thing will also happen when using an AC adapter.

CAUTION

The unit should be connected directly with the computer instead of via a USB hub.

13-1. Powering the unit with USB bus power

When the unit is off

1. Use a USB cable to connect the computer and the unit.
2. Turn the unit on.
The USB Screen will open.

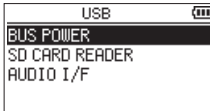

3. Use the + or - button to select BUS POWER item, and press the ► button.
The Home Screen will appear.

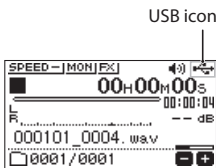

13-2. Using as an SD card reader

By connecting this unit with a computer using a USB cable, you can use it as an SD card reader. You can transfer recorded audio files to a computer and also transfer audio files from a computer to the unit.

When the unit is off

1. Use a USB cable to connect the computer and the unit.
2. Turn the unit on.
The USB Screen will open.

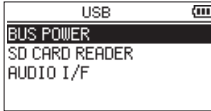

3. Use the + or - button to select the SD CARD READER item, and press the ► button.
The SD CARD READER Screen will open.



When the unit is on

1. When operating on batteries, connect the unit and the computer with a USB cable.
2. Press the MENU button to open the MENU Screen.

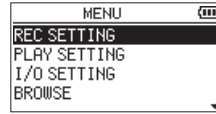

3. Use the + or - button to select USB item, and press the ► button.
The USB Screen will open.

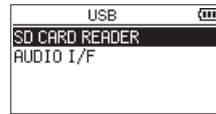

4. Use the + or - button to select the SD CARD READER item, and press the ► button.
The SD CARD READER Screen will open.



13-3. Disconnecting the unit from a computer

Before disconnecting the computer and the unit, use the proper procedures for the computer to unmount the unit, and press the **◀** button.

Disconnect from the computer and return to the Home Screen.

13-4. Transferring files from a computer

1. Click the "DR-07XP" drive on the computer screen to show the "MUSIC" and "UTILITY" folders.
2. Drag and drop files on the computer that you want to transfer to the unit to the "MUSIC" folder.

TIP

- You can manage the "MUSIC" folder from the computer.
- You can create subfolders in the "MUSIC" folder up to the second level for use with this unit. Only two levels of folders can be created. This unit cannot recognize subfolders and audio files on the third level or below.
- Since you can set the DR-07XP to only play the contents of a specific folder, you can organize files into genres, artists or other categories as you like.
- If you name the subfolders and music files, these names will appear on the screen of this unit.

13-5. Using as a USB audio interface

By connecting this unit with a computer using a USB cable, you can use it as a USB audio interface.

CAUTION

Recording is not possible when used as a USB audio interface

NOTE

96 kHz sampling rate is not supported.

Opening the AUDIO I/F Screen

When the unit is off

1. Use a USB cable to connect the computer and the unit.
2. Turn the unit on.
The USB Screen will open.

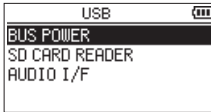

3. Use the + or – button to select the AUDIO I/F item, and press the ► button.
The AUDIO I/F Screen will open.

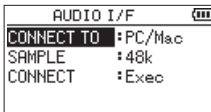

When the unit is on

1. When operating on batteries, connect the unit and the computer with a USB cable.
2. Press the MENU button to open the MENU Screen.

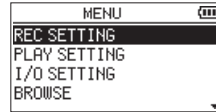

3. Use the + or – button to select USB item, and press the ► button.
The USB Screen will open.

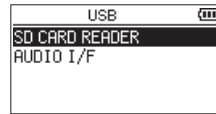

4. Use the + or – button to select the AUDIO I/F item, and press the ► button.
The AUDIO I/F Screen will open.

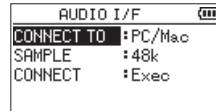

13. USB connection

Setting the connected device type

1. When the AUDIO I/F Screen is open, use the + or – button to select the CONNECT TO item, and press the ► button.
2. Use the + and – buttons to set the type of connected device.

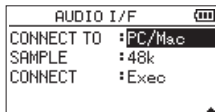

Options

PC/Mac (default)

iOS

NOTE

- With Windows, an ASIO driver for the DR-X series can be used. For details, please see the support website for this model. <https://tascam.jp/int/product/dr-07xp/support>
- With a Mac, the standard OS driver will be used, so there is no need to install any software.
- If the connected device type is iOS, this unit will operate on batteries.
- Lightning to USB Camera Adapter, for example, is necessary to connect to an iOS device.

Connecting

1. When the AUDIO I/F Screen is open, use the + or – button to select the CONNECT item, and press the ► button. Exec will appear highlighted.

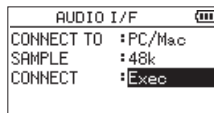

2. Press the ► button to enable audio interface mode and open the Home Screen. When in audio interface mode, "USB AUDIO I/F" will be shown on the display.



NOTE

When in audio interface mode, press the MENU button to access the following functions.

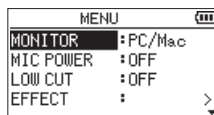

MONITOR

Set to DIRECT to mix the mic input and computer output sounds, enabling input monitoring without lag.

MIC POWER

When connecting a microphone that requires plug-in power, set this to ON.

LOW CUT

Set the cutoff frequency of the low-cut filter during input.

EFFECT

Open the effect settings screen.

DISCONNECT

End the USB audio interface mode connection.

14. Settings and Information

14-1. Viewing information (INFORMATION)

Use the Information Screen to view various types of information about this unit.

Follow the steps below to display the Information Screen.

1. Press the MENU button to open the MENU Screen.

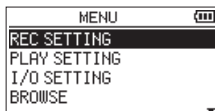

2. Use the + or – button to select OTHERS item, and press the ► button.
The OTHERS Screen opens.

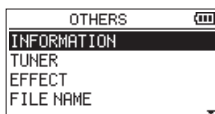

3. Use the + or – button to select the INFORMATION item, and press the ► button.

The Information Screen contains the following three pages.

Use the + or – button to move through the pages.

File information page (FILE)

Shows information about the currently loaded file.

Card information page (CARD)

Shows the use status of the currently inserted microSD card

System information page (SYSTEM)

Shows the unit's system setting information and firmware version.

File information page (FILE)

The FILE page shows information about the currently selected file.

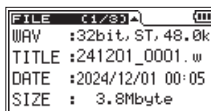

WAV/ MP3

This shows the audio file format.

For WAV files, the bit depth, stereo/mono setting and sampling rate (Hz) are shown.

For MP3 files, the bit rate (kbps), CBR (constant bit rate) or VBR (variable bit rate) type, and sampling frequency (Hz) also appear.

TITLE

Shows the file name.

If an MP3 file has ID3 tag title information that information appears.

DATE

Date of file creation

SIZE

File size

14. Settings and Information

Card information page (CARD)

The CARD page shows the status of the currently inserted microSD card.

CARD	C2/33	III
TOTAL MUSIC	: 10	
TOTAL FOLDER	: 2	
TOTAL SIZE	: 3.7G	
REMAIN SIZE	: 3.6G	

TOTAL MUSIC

Shows the number of playable files in the MUSIC Folder.

TOTAL FOLDER

Shows the total number of folders in the Music Folder.

TOTAL SIZE

Shows the total microSD card capacity.

REMAIN SIZE/ USED SIZE

Shows the amount of unused/used capacity on the microSD card.

Press the **I◀◀** or **▶▶I** button to switch between REMAIN SIZE and USED SIZE.

CARD	C2/33	III
TOTAL MUSIC	: 10	
TOTAL FOLDER	: 2	
TOTAL SIZE	: 3.7G	
USED SIZE	: 57.7M	

System information page (SYSTEM)

The SYSTEM page shows information about the unit's system settings and firmware version.

SYSTEM	C2/33	III
AUTO PWR SAVE	: 30min	
BACKLIGHT	: 5sec	
BATTERY TYPE	: ALKAL	
VERSION	: 1.11 0057	

AUTO PWR SAVE

Shows the automatic power OFF setting.

BACKLIGHT

Shows the automatic backlight OFF setting.

BATTERY

Shows the battery type setting.

VERSION

Shows the system firmware version.

14-2. System Settings

From the SYSTEM Screen, you can change various settings to optimize the device for your use environment and other requirements.

Setting the automatic power saving function

You can use the AUTO PWR SAVE item to set the amount of time from when the unit last operated or was used until the power turns off automatically.

1. Press the MENU button to open the MENU Screen.

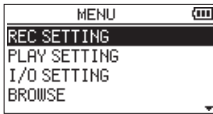

2. Use the + or – button to select the SYSTEM item, and press the ► button. This opens the SYSTEM Screen.

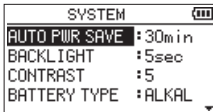

3. Use the + or – button to select AUTO PWR SAVE item, and press the ► button.
4. Use the + and – buttons to select the time.

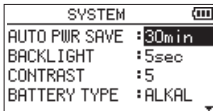

Options

OFF (does not turn off automatically)

3min

5min

10min

30min (default)

5. After completing the setting, press the ⏪/I (HOME) [■] button to return to the Home Screen.

Setting the backlight

Use the BACKLIGHT item to set the time after the last operation until the backlight automatically turns off.

1. Press the MENU button to open the MENU Screen.

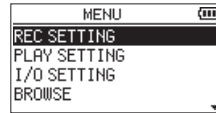

2. Use the + or – button to select the SYSTEM item, and press the ► button. This opens the SYSTEM Screen.

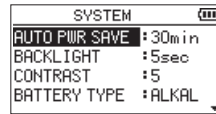

3. Use the + or – button to select the BACKLIGHT item, and press the ► button.
4. Use the + and – buttons to select the time.

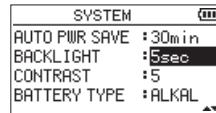

Options

OFF (backlight off)

5sec (default)

10sec

15sec

30sec

ALWAYS (always on)

5. After completing the setting, press the ⏪/I (HOME) [■] button to return to the Home Screen.

14. Settings and Information

Adjusting the display contrast

Use **CONTRAST** to adjust the display contrast.

1. Press the MENU button to open the MENU Screen.

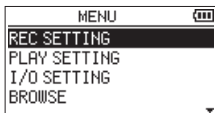

2. Use the + or – button to select the SYSTEM item, and press the ► button. This opens the SYSTEM Screen.

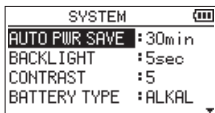

3. Use the + or – button to select CONTRAST item, and press the ► button.
4. Use the + and – buttons to select the value.

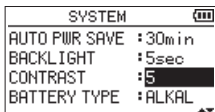

Options

1–20 (default: 5)

5. After completing the setting, press the ϕ /I (HOME) [■] button to return to the Home Screen.

Setting the battery type

Use the BATTERY TYPE item to set the battery type. This setting is used to display the remaining battery power and to calculate the minimum capacity for normal operation.

1. Press the MENU button to open the MENU Screen.

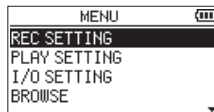

2. Use the + or – button to select the SYSTEM item, and press the ► button. This opens the SYSTEM Screen.

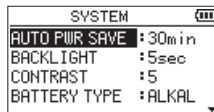

3. Use the + or – button to select the BATTERY TYPE item, and press the ► button.
4. Use the + and – buttons to select the type.

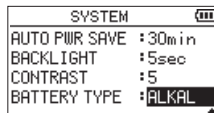

Options

ALKAL (alkaline batteries, default)

Ni-MH (nickel-metal hydride batteries)

5. After completing the setting, press the ϕ /I (HOME) [■] button to return to the Home Screen.

Set the language

Use the LANGUAGE item to set the language shown on the display.

1. Press the MENU button to open the MENU Screen.

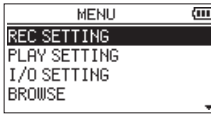

2. Use the + or – button to select the SYSTEM item, and press the ► button. This opens the SYSTEM Screen.

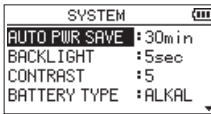

3. Use the + or – button to select the LANGUAGE item, and press the ► button.
4. Use the + and – buttons to select the desired display language.

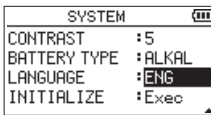

Options

- ENG: use English
- 日本語: use Japanese
- FRA: use French
- ESP: use Spanish
- DEU: use German
- ITA: use Italian
- POR: use Portuguese
- RUS: use Russian
- 中文: use Chinese
- 한글: use Korean

5. Press the ► button to open a pop-up confirmation window.



6. Press the ►► button to confirm the language selection. Press the ◀◀ button to cancel execution.

After execution, the display language will change and the SYSTEM Screen will reopen.

7. After completing the setting, press the ◻/1 (HOME) [■] button to return to the Home Screen.

Setting the language if the wrong was set

After pressing the ◻/1 (HOME) [■] button to turn the unit off, press the ◻/1 (HOME) [■] button while pressing and holding the MENU button.

The language selection menu will appear, and you will be able to select the language.

14. Settings and Information

Restoring the factory settings

Use the INITIALIZE item to restore the various settings of this unit to their factory settings.

1. Press the MENU button to open the MENU Screen.

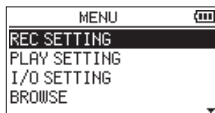

2. Use the + or – button to select the SYSTEM item, and press the ► button. This opens the SYSTEM Screen.

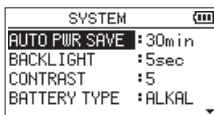

3. Use the + or – button to select the INITIALIZE item, and press the ► button. Exec will appear highlighted.

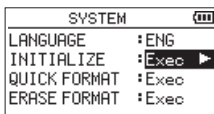

4. Press the ► button to open a pop-up confirmation window.

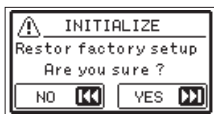

5. Press the ►► button to initialize the unit. Press the ◀◀ button to cancel execution.

When initialization completes, the SYSTEM Screen will reopen.

6. To return to the Home Screen, press the ◀/I (HOME) [■] button.

Formatting microSD cards

Use the QUICK FORMAT item to format a microSD card. Formatting a microSD card erases all music files on the card and automatically creates new “MUSIC” and “UTILITY” folders as well as a “dr-1.sys” file.

1. Press the MENU button to open the MENU Screen.

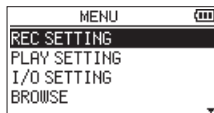

2. Use the + or – button to select the SYSTEM item, and press the ► button. This opens the SYSTEM Screen.

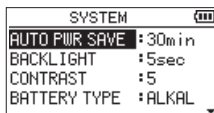

3. Use the + or – button to select the QUICK FORMAT item, and press the ► button. Exec will appear highlighted.

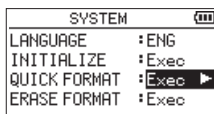

4. Press the ► button to open a pop-up confirmation window.



5. Press the ►► button to start formatting the microSD card. Press the ◀◀ button to cancel execution.

When formatting completes, the SYSTEM Screen will reopen.

6. To return to the Home Screen, press the ◀/I (HOME) [■] button.

Erasing and formatting microSD cards

Use the ERASE FORMAT item to completely format a microSD card.

Erasing and formatting a microSD card erases all music files on the card and automatically creates new "MUSIC" and "UTILITY" folders as well as a "dr-1.sys" file.

NOTE

- Using the ERASE FORMAT option might restore an SD card that has decreased writing performance due to repeated use.
- ERASE FORMAT checks the memory for errors while formatting, so it takes more time than QUICK FORMAT.

1. Press the MENU button to open the MENU Screen.

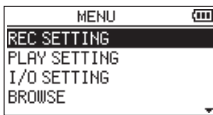

2. Use the + or – button to select the SYSTEM item, and press the ► button. This opens the SYSTEM Screen.

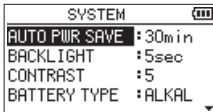

3. Use the + or – button to select the ERASE FORMAT item, and press the ► button. Exec will appear highlighted.

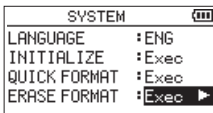

4. Press the ► button to open a pop-up confirmation window.



5. Press the ►► button to start erasing and formatting the microSD card. Press the ◀◀ button to cancel execution. When formatting completes, the SYSTEM Screen will reopen.
6. To return to the Home Screen, press the ◻/I (HOME) [■] button.

CAUTION

When formatting (or erasing and formatting) a microSD card, the batteries should have sufficient remaining power. Alternatively, the unit should be operating on power supplied by a TASCAM PS-P520U adapter (sold separately) or computer USB bus power. If the power turns off during formatting, proper formatting might not be possible.

14. Settings and Information

14-3. Setting the file name format

You can select the format of names given to files recorded by this unit.

This can be set to either the date (YYMMDD format) or a word (6 chosen characters)

DATE (default)

Example: 110101_0000.wav

WORD

Example: DR0000_0000.wav

NOTE

This unit does not have a function to change file names. Use a computer to edit file names.

1. Press the MENU button to open the MENU Screen.

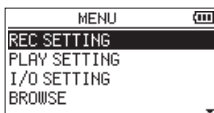

2. Use the + or – button to select OTHERS item, and press the ► button.
The OTHERS Screen opens.

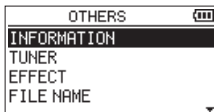

3. Use the + or – button to select the FILE NAME item, and press the ► button.
The FILE NAME Screen will open.



4. Use the ◀◀ or ▶▶ button and the + or – button to set each item.
On this screen you can make the following settings for each item.

TYPE

The TYPE item can be set to either WORD or DATE.

Options

DATE (default)

The date (YYMMDD format) is added to the file name.

Example: 110101_0000.wav

The date is set using the unit's internal clock. (see "Setting the date and time" on page 32)

WORD

The chosen characters (6) are added to the file name.

Use the WORD item to set the characters.

WORD

If WORD is selected for the TYPE item, use this to set the characters (6) added to the file name. (Default: TASCAM)

Example: DR0000_0000.wav

To set the WORD item, use the ◀◀ and ▶▶ buttons to move the cursor, and use the + or – button to select the character.

The usable characters are as follows.

English alphabet	Upper and lower case
Numbers	0 – 9
Symbols	! # \$ % & ' () + , - . : ; @ [] ^ _ ` { } ~

5. After completing the setting, press the ◀/1 (HOME) [■] button to return to the Home Screen.

14-4. Using a 2D code to access the Owner's Manual web page

The URL for a website that has the Owner's Manual can be shown as a 2D code on the display of this unit. By using a device to scan the 2D code, a document page on the website can be accessed.

NOTE

Please be aware that you are responsible for any transmission costs related to Internet connection.

1. Press the MENU button to open the MENU Screen.

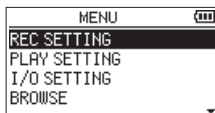

2. Use the + or - button to select the MANUALS item, and press the ► button. The DOCUMENT PAGE Screen will open.



3. Use a smartphone or similar device to scan the 2D code on the display to access a page with the Owner's Manual for this unit.
4. Press the MENU button to return to the MENU Screen.

15. Message

The following is a list of pop-up messages.

Refer to this list if one of these pop-up messages appears on the DR-07XP and you want to check the meaning or determine a proper response.

Message	Details and responses
File Name Err	The DIVIDE function would cause the file name to exceed 197 characters. Before choosing the DIVIDE function, connect the unit to a computer and edit the file name to less than 196 characters.
Dup File Name	The DIVIDE function would cause the file name to be the same as that of an existing file in the same folder. The DIVIDE function adds "_a" or "_b" to the end of the file name. Before choosing the DIVIDE function, connect the unit to a computer and edit the file name.
File Not Found	The file added to the playlist cannot be found or a file could be damaged. Please check that file.
Non-Supported	The audio file is not a supported format. Please see "Recording/playback format" on page 105 for file formats that this unit can use.
I/O Too Short	The IN and OUT points are too close together. Set them with at least 1 second between them.
File Not Found PLAYLIST	A file in the Playlist cannot be found. Please confirm that the file is still in the Music folder.
No PLAYLIST	No files have been added to the Playlist. Add a file to the Playlist or change the play mode to something besides PLAYLIST.
PLAYLIST FILL	The playlist is full. You cannot add more than 99 tracks to the Playlist.
MBR Error Init CARD	The microSD card might not be formatted properly, or it might be broken. Replace the microSD card, or press the ► button while this message is being shown to FAT format the card. <u>Execution of FAT formatting will erase all data on the microSD card.</u>
Format Error Format CARD Are you sure?	The microSD card might not be formatted properly, or it might be broken. This message also appears if the microSD card was FAT formatted using a computer connected by USB or if an unformatted microSD card was inserted in the unit. Always use the DR-07XP to conduct formatting. Replace the microSD card, or press the ► button while this message is being shown to FAT format the card. <u>Execution of FAT formatting will erase all data on the microSD card.</u>
File Not Found Make Sys File	The system file is missing. When this message appears, press the ► button to automatically create a system file.
Invalid SysFile Make Sys File	The system file required to operate this unit is invalid. When this message appears, press the ► button to automatically create a new system file.
Invalid Card Change Card	Something might be wrong with the microSD card. Change the microSD card.
Write error REC continue	Writing of the microSD card timed out. This has caused audio to be interrupted and noise to occur. A mark is added at the point when audio was interrupted.
Card slow Check BOF mark	microSD card writing performance has become worse. A mark has been added at a point when an interruption occurred because writing to the microSD card timed out. Check the audio around the BOF mark. Erase and format the microSD card or replace it.
Card Full	The microSD card has no remaining capacity. Erase unnecessary files or move them to your computer to make open space.
Can't Divide	The selected division point is not suitable. (It is too close to the beginning or end of the track.)
Max File Size	The file is larger than the designated size, or the recording time has exceeded 24 hours when the total number of folders and files was already at the limit (5000).
File Full	The total number of folders and files exceeds 5000. Erase unnecessary folders and files or move them to a computer.
Card Error	The microSD card could not be recognized properly. Change the microSD card.
Current File MP3	MP3 files cannot be divided or overwritten.

Message	Details and responses
File Protected	The file is read only and cannot be erased.
No Card	No microSD card is in the unit.
No PB File	There is no file that can be played back. The file might be damaged.
No MUSIC File	There is no playback file, so dividing or overdubbing cannot be executed.
Cannot overdub! See REC setting	You cannot make an mp3 file when overdubbing a WAV file with a sampling frequency of 96 kHz. Change the recording format to WAV. Overdubbing is also not possible when the channel settings differ from the playback file. Check the channel settings.
UNDO Can not execute	Undoing is not possible because there is no data that can be undone.
Not Continued	<p>If any of these errors occurs, turn the unit's power off and restart it. If the power cannot be turned off, remove the batteries, disconnect the AC adapter (TASCAM PS-P520U), and/or disconnect the USB cable for bus power supply. Reinserting the microSD card might also resolve the problem. If these error messages continue to appear frequently, please contact the store where you purchased this unit or TASCAM customer support service.</p>
File Error	
Can't Save Data	
Player Error	
Device Error	
Writing Failed	
Sys Rom Err	
System Err 50	
System Err 1	
System Err 2	
System Err 3	
System Err 4	
System Err 5	
System Err 6	
System Err 7	
System Err 8	
System Err 9	

16. Troubleshooting

If you are having trouble with the operation of this unit, please try the following before seeking repair. If these measures do not solve the problem, please contact the store where you purchased this unit or TASCAM customer support service.

The unit does not turn on.

- Confirm that batteries are installed correctly.
- Confirm that the HOLD switch is not set.

The unit turns off automatically

Check the automatic power saving function setting. Set it to "Off" to prevent the power from turning off automatically. (see "Setting the automatic power saving function" on page 95)

The microSD card is not recognized.

Check that the microSD card is inserted correctly.

No sound is output or sound is not output from the speaker.

- Confirm that the output volume is not lowered too much.
- Confirm that the speaker setting is on. Even if the speaker is on, sound will not be output from the speaker in the following cases.
 - Headphones are connected
 - When recording or in recording standby
 - When in overdubbing mode (see "Enabling overdubbing mode" on page 48)

Recording is not possible.

- Confirm that the REC indicator is lit. If the REC indicator is blinking, the unit is in recording standby.
- Check the remaining available recording time shown on the recording screen.

The recorded sound is quiet or distorted.

Check the input level setting.

Playback sounds distorted even though recorded using 32-bit float

- If the level exceeds 0 dB during playback, adjust it using, for example, editing software on a computer.
- If distortion occurs at the input section due to excessive input levels during recording, the distortion will remain even if the level is adjusted.
- This unit does not have a function for adjusting levels after recording. Make adjustments using, for example, editing software on a computer.

The unit is not recognized by a computer connected using a USB cable.

- Use a USB cable that can transmit data.
- Confirm that the connected computer uses a compatible operating system.
- The USB function used must be selected from the menu to enable a computer to recognize this unit.
- Confirm that the USB cable is not designed only for charging.
- Confirm that the connection is not being made through a USB hub.

Sound skips or noise occurs when in USB audio interface mode.

For Windows

- Performance options
Select "Adjust for best performance".
- Power options
Select "High performance".
- Use an ASIO driver for the DR-X series.
For details, please see the support website for this model.
<https://tascam.jp/jp/product/dr-07xp/support>
- Select the sampling rate to suit the recording app being used.

The wrong language was set accidentally.

After pressing the $\phi/1$ (HOME) [■] button to turn the unit off, press the $\phi/1$ (HOME) [■] button while pressing and holding the MENU button.

The language selection menu will appear, and you will be able to select the language.

17-1. Ratings

Recording media

microSD card
microSDHC card
microSDXC card (up to 512 GB)

Recording/playback format

WAV

Sampling frequency

44.1/48/96 kHz

Quantization bit depth

16-bit/24-bit/32-bit float

MP3

Sampling frequency

44.1/48 kHz

Bit rate

32/64/96/128/192/256/320 kbps

Number of channels

Input channels

2 (stereo)

Recording tracks

2 (stereo)

17-2. Input/output ratings

Analog audio input/output ratings

MIC/EXT IN jack (can provide plug-in power)

Connector

1/8" (3.5mm) stereo mini jack

Input impedance

18 k Ω or higher (PLUG IN PWR = OFF)
2 k Ω or higher (PLUG IN PWR = ON)

Nominal input level

-20 dBV

Maximum input level

-4 dBV

/LINE OUT jack

Connector

1/8" (3.5mm) stereo mini jack

Output impedance

12 Ω

Nominal output level

-14 dBV (with 10 k Ω load)

Maximum output level

+2 dBV (with 10 k Ω load)

Maximum output

20 mW + 20 mW (32 Ω load)

Working impedance

16-250 Ω

Built-in speaker

0.3 W (mono)

Note: 0 dBV=1 Vrms, 0 dBu=0.775 Vrms

17. Specifications

Control input/output ratings

USB

Connector

Type-C

Format

USB 2.0 HIGH SPEED mass storage class

USB 1.1 FULL SPEED audio class

USB Audio

Sampling frequency

44.1/48 kHz

Quantization bit depth

24-bit

Number of inputs

2 channels

Number of outputs

2 channels

17-3. Audio performance

Frequency response

20 Hz – 20 kHz +0/–1 dB

(MIC/EXT IN to LINE OUT, 44.1 kHz sampling frequency, JEITA)

20 Hz – 22 kHz +0/–1 dB

(MIC/EXT IN to LINE OUT, 48 kHz sampling frequency, JEITA)

20 Hz – 40 kHz +0/–1.5 dB

(MIC/EXT IN to LINE OUT, 96 kHz sampling frequency, JEITA)

Total harmonic distortion ratio (THD+N)

0.01% or less

(MIC/EXT IN to LINE OUT, 44.1/48/96 kHz sampling frequency, JEITA)

Note: JEITA indicates conformance to JEITA CP-2150

17-4. Other specifications

Power

2 AA batteries (alkaline or NiMH, sold separately)

USB bus power from a computer 5 V/0.5 A

Dedicated AC adapter (TASCAM PS-P520U, sold separately):

DC 5V/2A

Power consumption

1.7 W (maximum)

Battery operation time (continuous operation)

- Using alkaline batteries (EVOLTA)

Recording/ playback	File format (recording setting)	Operation time	Note
Recording	WAV, 96 kHz, 32-bit float	About 14.5 hours	With built-in stereo mic input
	WAV, 96 kHz, 24-bit	About 15.5 hours	With built-in stereo mic input
	WAV, 44.1 kHz, 16-bit	About 17.5 hours	With built-in stereo mic input
	MP3, 44.1 kHz, 128 kbps	About 13 hours	With built-in stereo mic input
	MP3, 48 kHz, 320 kbps	About 11 hours	With built-in stereo mic input
Playback	WAV, 96 kHz, 32-bit float	About 11 hours	Using headphones
		About 11 hours	Using built-in speaker
	WAV, 96 kHz, 24-bit	About 14 hours	Using headphones
		About 14 hours	Using built-in speaker
	WAV, 44.1 kHz, 16-bit	About 16.5 hours	Using headphones
		About 16.5 hours	Using built-in speaker
	MP3, 44.1 kHz, 128 kbps	About 16.5 hours	Using headphones
		About 16.5 hours	Using built-in speaker
	MP3, 48 kHz, 320 kbps	About 15.5 hours	Using headphones
		About 15.5 hours	Using built-in speaker

Recording: JEITA recording time

Playback: JEITA music playback time

- Using NiMH battery (eneloop)

Recording/ playback	File format (recording setting)	Operation time	Note
Recording	WAV, 96 kHz, 32-bit float	About 11.5 hours	With built-in stereo mic input
	WAV, 96 kHz, 24-bit	About 12.5 hours	With built-in stereo mic input
	WAV, 44.1 kHz, 16-bit	About 14.5 hours	With built-in stereo mic input
	MP3, 44.1 kHz, 128 kbps	About 13 hours	With built-in stereo mic input
	MP3, 48 kHz, 320 kbps	About 10 hours	With built-in stereo mic input
Playback	WAV, 96 kHz, 32-bit float	About 10 hours	Using headphones
		About 10 hours	Using built-in speaker
	WAV, 96 kHz, 24-bit	About 13 hours	Using headphones
		About 12 hours	Using built-in speaker
	WAV, 44.1 kHz, 16-bit	About 14 hours	Using headphones
		About 15 hours	Using built-in speaker
	MP3, 44.1 kHz, 128 kbps	About 13.5 hours	Using headphones
		About 13 hours	Using built-in speaker
	MP3, 48 kHz, 320 kbps	About 13.5 hours	Using headphones
		About 13 hours	Using built-in speaker

Recording: JEITA recording time

Playback: JEITA music playback time

NOTE

The battery operation times (during continuous operation) could vary depending on the media being used.

17. Specifications

Dimensions

68 x 159.6 x 27 mm (W x H x D, when the microphone pair is closed)
90.3 x 159.6 x 27 mm (when the microphone pair is open)

Weight

184/136 g (with/without batteries)

Operating temperature range

0°C–40°C

- Illustrations in this manual might differ in part from the actual product.
- Specifications and external appearance might be changed without notification to improve the product.

17-5. Dimensional drawings

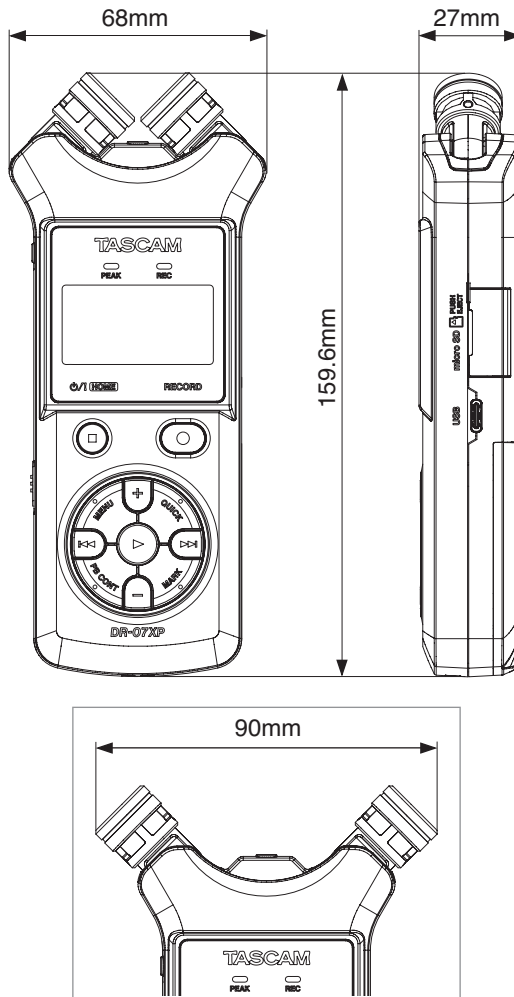

Dimension of the microphone opened

TASCAM

TEAC CORPORATION

<https://tascam.jp/jp/>

1-47 Ochiai, Tama-shi, Tokyo 206-8530 Japan

TEAC AMERICA, INC.

<https://tascam.com/us/>

10410 Pioneer Blvd., Unit #3, Santa Fe Springs, California 90670, U.S.A

TEAC UK Ltd.

<https://www.tascam.eu/en/>

Luminous House, 300 South Row, Milton Keynes, Buckinghamshire, MK9 2FR, UK

TEAC EUROPE GmbH

<https://www.tascam.eu/de/>

Bahnstrasse 12, 65205 Wiesbaden-Erbenheim, Germany

TEAC SALES & TRADING(SHENZHEN) CO., LTD

<https://tascam.cn/cn/>

Room 817, Xinian Center A, Tairan Nine Road West, Shennan Road, Futian District, Shenzhen,
Guangdong Province 518040, China

1124.MA-3898A