

TASCAM

D01194420F



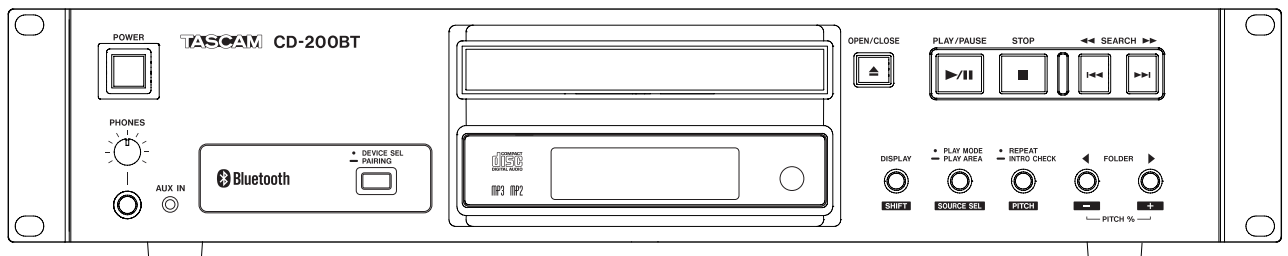

CD-200BT

CD Player / Bluetooth Receiver

OWNER'S MANUAL



IMPORTANT SAFETY INSTRUCTIONS

  	CAUTION: TO REDUCE THE RISK OF ELECTRIC SHOCK, DO NOT REMOVE COVER (OR BACK). NO USER-SERVICEABLE PARTS INSIDE. REFER SERVICING TO QUALIFIED SERVICE PERSONNEL.
	The lightning flash with arrowhead symbol, within equilateral triangle, is intended to alert the user to the presence of uninsulated "dangerous voltage" within the product's enclosure that may be of sufficient magnitude to constitute a risk of electric shock to persons.
	The exclamation point within an equilateral triangle is intended to alert the user to the presence of important operating and maintenance (servicing) instructions in the literature accompanying the appliance.

WARNING: TO PREVENT FIRE OR SHOCK HAZARD, DO NOT EXPOSE THIS APPLIANCE TO RAIN OR MOISTURE.

For U.S.A.

Supplier's Declaration of Conformity

Model Number: CD-200BT

Trade Name: TASCAM

Responsible party: TEAC AMERICA, INC.

Address: 10410 Pioneer Blvd., Unit #3, Santa Fe Springs, CA 90670, U.S.A

Telephone number: 1-323-726-0303



This device complies with "Part 15 of FCC Rules".

Operation is subject to the following two conditions:

- (1) This device may not cause interference, and
- (2) This device must accept any interference, including interference that may cause undesired operation of this device.

INFORMATION TO THE USER

This equipment has been tested and found to comply with the limits for a Class A digital device, pursuant to Part 15 of the FCC Rules. These limits are designed to provide reasonable protection against harmful interference when the equipment is operated in a commercial environment. This equipment generates, uses, and can radiate radio frequency energy and, if not installed and used in accordance with the instructions, may cause harmful interference to radio communications.

Operation of this equipment in a residential area is likely to cause harmful interference in which case the user will be required to correct the interference at his own expense.

CAUTION

Changes or modifications to this equipment not expressly approved by TEAC CORPORATION for compliance could void the user's authority to operate this equipment.

IN USA/CANADA, USE ONLY ON 120 V SUPPLY.

For Canada

THIS CLASS A DIGITAL APPARATUS COMPLIES WITH CANADIAN ICES-003.

APPAREIL NUMERIQUE DE LA CLASSE A EST CONFORME A LA NORME NMB-003 DU CANADA.

For the customers in Europe

WARNING

This equipment is compliant with Class A of CISPR 32. In a residential environment this equipment may cause radio interference.

1. Read these instructions.
2. Keep these instructions.
3. Heed all warnings.
4. Follow all instructions.
5. Do not use this apparatus near water.
6. Clean only with dry cloth.
7. Do not block any ventilation openings. Install in accordance with the manufacturer's instructions.
8. Do not install near any heat sources such as radiators, heat registers, stoves, or other apparatus (including amplifiers) that produce heat.
9. Do not defeat the safety purpose of the polarized or grounding-type plug. A polarized plug has two blades with one wider than the other. A grounding type plug has two blades and a third grounding prong. The wide blade or the third prong are provided for your safety. If the provided plug does not fit into your outlet, consult an electrician for replacement of the obsolete outlet.
10. Protect the power cord from being walked on or pinched particularly at plugs, convenience receptacles, and the point where they exit from the apparatus.
11. Only use attachments/accessories specified by the manufacturer.

IMPORTANT SAFETY INSTRUCTIONS

- 12.** Use only with the cart, stand, tripod, bracket, or table specified by the manufacturer, or sold with the apparatus. When a cart is used, use caution when moving the cart/apparatus combination to avoid injury from tip-over.



- 13.** Unplug this apparatus during lightning storms or when unused for long periods of time.
- 14.** Refer all servicing to qualified service personnel. Servicing is required when the apparatus has been damaged in any way, such as power-supply cord or plug is damaged, liquid has been spilled or objects have fallen into the apparatus, the apparatus has been exposed to rain or moisture, does not operate normally, or has been dropped.

- The apparatus draws nominal non-operating power from the AC outlet with its POWER or STANDBY/ON switch not in the ON position.
- The mains plug is used as the disconnect device, the disconnect device shall remain readily operable.
- Caution should be taken when using earphones or headphones with the product because excessive sound pressure (volume) from earphones or headphones can cause hearing loss.
- If you are experiencing problems with this product, contact TEAC for a service referral. Do not use the product until it has been repaired.

WARNING

- To prevent possible hearing damage, do not listen at high volume levels for long periods.



CAUTION

- Do not expose this apparatus to drips or splashes.
- Do not place any objects filled with liquids, such as vases, on the apparatus.
- Do not install this apparatus in a confined space such as a book case or similar unit.
- The apparatus should be located close enough to the AC outlet so that you can easily grasp the power cord plug at any time.
- If the product uses batteries (including a battery pack or installed batteries), they should not be exposed to sunshine, fire or excessive heat.
- CAUTION for products that use replaceable lithium batteries: there is danger of explosion if a battery is replaced with an incorrect type of battery. Replace only with the same or equivalent type.
- Installed battery subjected to extremely low air pressure may result in an explosion or the leakage of flammable liquid or gas.

CAUTION

- DO NOT REMOVE THE EXTERNAL CASES OR CABINETS TO EXPOSE THE ELECTRONICS. NO USER SERVICEABLE PARTS ARE INSIDE.
- IF YOU ARE EXPERIENCING PROBLEMS WITH THIS PRODUCT, CONTACT THE STORE WHERE YOU PURCHASED THE UNIT FOR A SERVICE REFERRAL. DO NOT USE THE PRODUCT UNTIL IT HAS BEEN REPAIRED.
- USE OF CONTROLS OR ADJUSTMENTS OR PERFORMANCE OF PROCEDURES OTHER THAN THOSE SPECIFIED HEREIN MAY RESULT IN HAZARDOUS RADIATION EXPOSURE.

RACK-MOUNTING THE UNIT

Use the supplied rack-mounting kit to mount the unit in a standard 19-inch rack, as shown below.

Remove the feet of the unit before mounting.

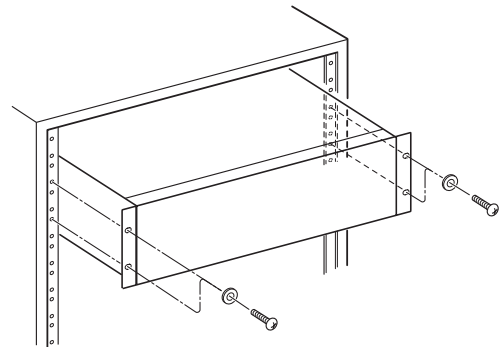

CAUTION

- Leave 1U of space above the unit for ventilation.
- Allow at least 10 cm (4 in) at the rear of the unit for ventilation.

IMPORTANT SAFETY INSTRUCTIONS

LASER INFORMATION

This laser product is a consumer laser product according to EN 50689:2021 and complies with all consumer laser product requirements except child appealing products.

This product contains a laser system and is classified as a CLASS 1 LASER PRODUCT according to IEC 60825-1:2014. This class does not require special attention in normal use. Do not take apart to prevent being exposed to the laser beam.

Notes on Laser Product

This product has been designed and manufactured according to FDA regulations "title 21, CFR, chapter 1, subchapter J, based on the Radiation Control for Health and Safety Act of 1968," and is classified as a class 1 laser product. There is no hazardous invisible laser radiation during operation because invisible laser radiation emitted inside of this product is completely confined in the protective housings.

The label required in this regulation is shown at ①.

For U.S.A

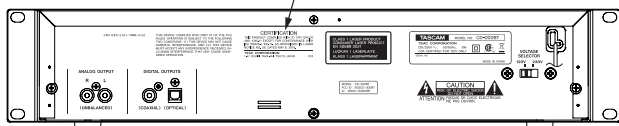

CAUTION

- **DO NOT REMOVE THE PROTECTIVE HOUSING USING A SCREWDRIVER.**
- **USE OF CONTROLS OR ADJUSTMENTS OR PERFORMANCE OF PROCEDURES OTHER THAN THOSE SPECIFIED HEREIN MAY RESULT IN HAZARDOUS RADIATION EXPOSURE.**

Optical pickup

Type : EP-C101

Manufacturer : Ever Bright Technology and Science
Electronical Co.,LTD

Laser output : Less than 0.3 mW

Wavelength : 790±25nm

CAUTIONS ABOUT BATTERIES

This product uses batteries. Misuse of batteries could cause a leak, rupture or other trouble. Always abide by the following precautions when using batteries.

- Never recharge non-rechargeable batteries. The batteries could rupture or leak, causing fire or injury.
- When installing batteries, pay attention to the polarity indications (plus/minus (+/-) orientation), and install them correctly in the battery compartment as indicated. Putting them in backward could make the batteries rupture or leak, causing fire, injury or stains around them.
- When you store or dispose batteries, isolate their terminals with insulation tape or something like that to prevent them from contacting other batteries or metallic objects.
- When throwing used batteries away, follow the disposal instructions indicated on the batteries and the local disposal laws.
- Do not use batteries other than those specified. Do not mix and use new and old batteries or different types of batteries together. The batteries could rupture or leak, causing fire, injury or stains around them.

- Do not carry or store batteries together with small metal objects. The batteries could short, causing leak, rupture or other trouble.
- Do not heat or disassemble batteries. Do not put them in fire or water. Batteries could rupture or leak, causing fire, injury or stains around them.
- If the battery fluid leaks, wipe away any fluid on the battery case before inserting new batteries. If the battery fluid gets in an eye, it could cause loss of eyesight. If fluid does enter an eye, wash it out thoroughly with clean water without rubbing the eye and then consult a doctor immediately. If the fluid gets on a person's body or clothing, it could cause skin injuries or burns. If this should happen, wash it off with clean water and then consult a doctor immediately.
- The unit power should be off when you install and replace batteries.
- Remove the batteries if you do not plan to use the unit for a long time. Batteries could rupture or leak, causing fire, injury or stains around them. If the battery fluid leaks, wipe away any fluid on the battery compartment before inserting new batteries.
- Do not disassemble a battery. The acid inside the battery could harm skin or clothing.

For European Customers

Disposal of electrical and electronic equipment and batteries and/or accumulators

- a) All electrical/electronic equipment and waste batteries/accumulators should be disposed of separately from the municipal waste stream via collection facilities designated by the government or local authorities.
- b) By disposing of electrical/electronic equipment and waste batteries/accumulators correctly, you will help save valuable resources and prevent any potential negative effects on human health and the environment.
- c) Improper disposal of waste electrical/electronic equipment and batteries/accumulators can have serious effects on the environment and human health because of the presence of hazardous substances in the equipment.
- d) The Waste Electrical and Electronic Equipment (WEEE) symbols, which show wheeled bins that have been crossed out, indicate that electrical/electronic equipment and batteries/accumulators must be collected and disposed of separately from household waste.
If a battery or accumulator contains more than the specified values of lead (Pb) and/or cadmium (Cd) as defined in the Battery Regulation (EU) 2023/1542, then the chemical symbols for those elements will be indicated beneath the WEEE symbol.
- e) Return and collection systems are available to end users. For more detailed information about the disposal of old electrical/electronic equipment and waste batteries/accumulators, please contact your city office, waste disposal service or the shop where you purchased the equipment.



Pb, Cd

Wireless equipment precautions

Compliance of radio transmitter and interference

This product has the function of broadband transmitter using 2.4GHz Band.

Use frequency range: 2402 MHz - 2480 MHz

Maximum output power: Bluetooth® Class 2 (less than 2.5 mW)

Please use only in the country where you purchased the product. Depending on the country, restrictions on the use of Bluetooth wireless technology might exist.

Model for USA

Labeling of authorization

FCC ID: XEG-CD200BT

Model for Canada

Compliance of radio transmitter

This device complies with Innovation, Science and Economic Development Canada's licence-exempt RSSs.

Operation is subject to the following two conditions:

- 1) This device may not cause interference
- 2) This device must accept any interference, including interference that may cause undesired operation of the device

Labeling of authorization

IC: 1559C-CD200BT

Modèle pour le Canada

Conformité de l'émetteur radio

Cet appareil est conforme aux normes CNR sans licence d'Innovation, Sciences et Développement économique Canada.

Son fonctionnement est soumis aux deux conditions suivantes:

- 1) Cet appareil ne doit pas provoquer d'interférences
- 2) Cet appareil doit accepter toute interférence, y compris celles susceptibles de provoquer un fonctionnement indésirable de l'appareil

Marquage d'autorisation

IC : 1559C-CD200BT

Model for EEA (European Economic Area)



Hereby, TEAC CORPORATION declares that the radio equipment type CD-200BT is in compliance with Directive 2014/53/EU, and the other European Directives, or Commission Regulations.

Model for UK



Hereby, TEAC CORPORATION declares that the radio equipment type CD-200BT is in compliance with UK Radio Equipment Regulations.

The full text of the EU and UK declaration of conformity is available at the following internet address: Please contact us by e-mail.

<https://tascam.eu/en/contact.html>

Radiation Exposure requirements

This equipment meets the regulation, which is recognized internationally, for the case of human exposure to radio waves generated by the transmitter.

Statement of compliance

Model for USA/Canada

This equipment complies with FCC/IC radiation exposure limits set forth for an uncontrolled environment and meets the FCC radio frequency (RF) Exposure Guidelines and RSS-102 of the IC radio frequency (RF) Exposure rules. This equipment has very low levels of RF energy that it deemed to comply without maximum permissive exposure evaluation (MPE). But it is desirable that it should be installed and operated keeping the radiator at least 20 cm or more away from person's body (excluding extremities: hands, wrists, feet and ankles).

Modèle pour les États-Unis/Canada

Cet équipement est conforme aux limites d'exposition aux rayonnements énoncées pour un environnement non contrôlé et respecte les règles les radioélectriques (RF) de la FCC lignes directrices d'exposition et d'exposition aux fréquences radioélectriques (RF) CNR-102 de l'IC. Cet équipement émet une énergie RF très faible qui est considérée conforme sans évaluation de l'exposition maximale autorisée. Cependant, cet équipement doit être installé et utilisé en gardant une distance de 20 cm ou plus entre le dispositif rayonnant et le corps (à l'exception des extrémités : mains, poignets, pieds et chevilles).

Model for EEA and UK

This equipment complies with EN 62479; Assessment of the compliance of low power electronic and electrical equipment with the basic restrictions related to human exposure to electromagnetic fields.

Contents

IMPORTANT SAFETY INSTRUCTIONS	2
Wireless equipment precautions	5
1 – Introduction	7
Features	7
Included items	7
Conventions used in this manual.....	7
Trademarks.....	8
Precautions for placement	8
Power supply	8
Beware of condensation	8
Cleaning the unit	8
Using the TEAC Global Site.....	8
About TASCAM customer support service.....	8
About discs	9
Handling of compact discs	9
Bluetooth overview.....	9
Transmission conditions	9
Profiles.....	9
Codecs.....	9
Content protection.....	9
Transmission security.....	9
2 – Names and functions of parts	10
Top panel	10
Rear panel.....	11
Display	12
Remote control unit (TASCAM RC-CD200BT).....	12
3 – Preparations	14
Making connections	14
Connecting a device to the AUX IN jack.....	15
Preparing the remote control.....	15
Inserting batteries.....	15
Replacing the batteries	15
Cautions about the use of batteries	15
Cautions about using the remote control.....	15
Loading a CD	16
Selecting the audio to output (current source)	16
4 – CD playback	17
Playable discs and files	17
Folders and tracks on data CDs	17
Playback area	18
Setting the playback area.....	18
Playback modes.....	18
Selecting the playback mode	18
Playback	19
Selecting a track.....	19
Skipping to the next or previous track.....	19
Selecting by track number.....	19
Search forward and backward	20
Folder playback (data CDs).....	20
Setting the playback folder	20
Programmed playback	20
Setting the program.....	20
Checking the program	21
Replacing a program track.....	21
Adding more program tracks	22
Clearing the program	22
Repeat playback.....	22
Time and text information display	23
Pitch control.....	24
Intro Check function.....	24
5 – Bluetooth device playback	25
Pairing	25
Searching for Bluetooth devices	25
Controlling Bluetooth devices	25
Playback from Bluetooth devices.....	25
Bluetooth information display	26
Deleting pairing information.....	26
6 – Message Lists	27
Operation messages.....	27
Warning messages	27
Error messages.....	27
7 – Troubleshooting	28
8 – Specifications	29
Ratings	29
Input and output ratings.....	29
Analog audio input.....	29
Analog audio output ratings.....	29
Digital audio output ratings.....	29
Audio performance.....	29
Backup memory	29
Bluetooth	29
General	30
Dimensions	30

1 – Introduction

Thank you for your purchase of the TASCAM CD-200BT CD Player / Bluetooth Receiver.

Before connecting and using the unit, please take time to read this manual thoroughly to ensure you understand how to properly set up and connect the unit, as well as the operation of its many useful and convenient functions. After you have finished reading this manual, please keep it in a safe place for future reference.

You can also download the Owner's Manual from the TEAC Global Site (<https://teac-global.com/>).

Features

- Plays back audio CDs (CD-DA) and data CDs (CD-ROM/RW) with WAV, MP3 and MP2 format files.
- 2U rack mount size
- Analog (RCA) and digital (coaxial and optical) outputs
- Headphone output with level control
- TASCAM RC-CD200BT remote control with number (0-9) buttons included
- Displays CD text and ID3 tag information (including artist, album and track names)
- 4 playback modes (continuous, single, random and program)
- Repeat playback function can be turned ON and OFF
- Playback area can be designated for data CDs (ALL PLAY or FOLDER)
- CD playback pitch control function ($\pm 14\%$)
- Intro check function
- Time can be displayed as track elapsed time, track remaining time or total remaining time for audio CDs and as track elapsed time for data CDs
- CD drive has 10-second shockproof memory (protection against skipping).
- Built-in Bluetooth® audio receiver enables output of audio from computers and portable audio devices that support Bluetooth (A2DP)
- In addition to SBC, Bluetooth (A2DP) supports AAC and Qualcomm®aptX™ audio decoding, enabling the reception of high-quality audio
- Bluetooth (A2DP) also supports SCMS-T, enabling the reception of protected audio content
- Stereo line mini jack enables audio input from portable audio players that do not support Bluetooth

Included items

This product includes the following items.

Take care when opening the package not to damage the items. Keep the packing materials for transportation in the future.

Please contact the store where you purchased this unit if any of these items are missing or have been damaged during transportation.

- Main unit x 1
- Wireless remote control unit (RC-CD200BT) x 1
- AA batteries x 2
- A rack-mounting screw kit..... x 1
- TASCAM ID registration guide x 1
- Warranty card x 1
- Owner's Manual (this manual)..... x 1

Conventions used in this manual

In this manual, we use the following conventions:

- Buttons, connectors and other parts of the unit and external devices are indicated like this: **DISPLAY** button
- Text displayed on the display of the unit and external devices appears like this: **ON**.
- CD-DA format discs are sometimes called "audio CDs."
- CDs that contain audio files in MP2, MP3 or WAV formats are called "data CDs."
- Audio CDs and data CDs are sometimes generically called "CDs".
- MP3, MP2 and WAV files are sometimes generically called "audio files".
- The currently selected audio source is called the "current source".
- The currently selected folder is called the "current folder".
- The currently selected file is called the "current file".
- A computer, portable audio device or other equipment that is connected to this unit by Bluetooth is called a "Bluetooth device".
- Additional information is provided as necessary as tips, notes and cautions.

TIP

These are tips about how to use the unit.

NOTE

These provide additional explanations and describe special cases.

CAUTION

Failure to follow these instructions could result in injury, damage to equipment or lost recording data, for example.

1 – Introduction

Trademarks

- TASCAM is a registered trademark of TEAC Corporation.
- The Bluetooth® word mark and logos are registered trademarks owned by Bluetooth SIG, Inc. and any use of such marks by TEAC CORPORATION is under license.
- Qualcomm aptX is a product of Qualcomm Technologies, Inc. and/or its subsidiaries.
- Qualcomm is a trademark of Qualcomm Incorporated, registered in the United States and other countries. aptX is a trademark of Qualcomm Technologies International, Ltd., registered in the United States and other countries.



Qualcomm® aptX™

- MPEG Layer-3 audio coding technology licensed from Fraunhofer IIS and Thomson.
- Other company names, product names and logos in this document are the trademarks or registered trademarks of their respective owners.

Any data, including, but not limited to information, described herein are intended only as illustrations of such data and/or information and not as the specifications for such data and/or information. TEAC Corporation disclaims any warranty that any use of such data and/or information shall be free from infringement of any third party's intellectual property rights or other proprietary rights, and further, assumes no liability of whatsoever nature in the event of any such infringement, or arising from or connected with or related to the use of such data and/or information.

This product is designed to help you record and reproduce sound works to which you own the copyright, or where you have obtained permission from the copyright holder or the rightful licensor. Unless you own the copyright, or have obtained the appropriate permission from the copyright holder or the rightful licensor, your unauthorized recording, reproduction or distribution thereof may result in severe criminal penalties under copyright laws and international copyright treaties. If you are uncertain about your rights, contact your legal advisor. Under no circumstances will TEAC Corporation be responsible for the consequences of any illegal copying performed using the recorder.

Precautions for placement

- The operating temperature should be between 5°C and 35°C (41°F and 95°F).
- Make sure that the unit is mounted in a level position for correct operation.
- Do not place any object on the unit for heat dissipation.
- Avoid installing this unit on top of any heat-generating electrical device such as a power amplifier.

Power supply

Connect the unit to the standard power outlet. Hold the plug when connecting and disconnecting the power cord.

Beware of condensation

If the unit is moved from a cold to a warm place, or used immediately after a cold room has been heated or otherwise exposed to a sudden temperature change, condensation could occur. Should this happen, leave the unit for one or two hours before turning the unit on.

Cleaning the unit

To clean the unit, wipe it gently with a soft dry cloth. Do not wipe with chemical cleaning cloths, paint thinner, ethyl alcohol or other chemical agents to clean the unit as they could damage the surface.

Once every five years, please contact the retailer where you purchased the unit or a TASCAM service center for internal cleaning. If the unit is not cleaned for a long time and dust is allowed to accumulate inside it, fire or malfunction could result. Cleaning is more effective when conducted before the humid season. Please check with us about the cost of internal cleaning.

Using the TEAC Global Site

You can download updates for this unit from the TEAC Global Site: <https://teac-global.com/>

In the TASCAM Downloads section, select the desired language to open the Downloads website page for that language.

About TASCAM customer support service

TASCAM products are supported and warranted only in their country/region of purchase.

To receive support after purchase, on the TASCAM Distributors list page of the TEAC Global Site (<https://teac-global.com/>), search for the local company or representative for the region where you purchased the product and contact that organization.

When making inquiries, the address (URL) of the shop or web shop where it was purchased and the purchase date are required.

Moreover, the warranty card and proof of purchase might also be necessary.

About discs

In addition to audio CDs (CD-DA), the CD-200BT can play CD-R and CD-RW discs on which audio CD, MP3, MP2 or WAV format files are recorded. The CD player can also play 3-inch CDs.

Handling of compact discs

- Always place the compact discs in the trays with their label facing upward.
- To remove a disc from its case, press down on the center of the disc holder, then lift the disc out, holding it carefully by the edges.
- Do not touch the signal side (the unlabeled side). Fingerprints, oils and other substances can cause errors during playing.
- To clean the signal side of a disc, wipe gently with a soft dry cloth from the center towards the outside edge. Dirt on discs can lower the sound quality, so clean them and always store them in a clean state.
- Do not use any record spray, anti-static solutions, benzine, paint thinner or other chemical agents to clean CDs. This could damage the delicate playing surface and cause CDs to become unplayable.
- Do not apply labels or other materials to discs. Do not use discs that have had tape, stickers or other materials applied to their surface. Do not use discs that have sticky residue from stickers, etc. Such discs could become stuck in the unit or cause it to malfunction.
- Never use a commercially available CD stabilizer. Using stabilizers with this unit will damage the mechanism and cause it to malfunction.
- Do not use cracked discs.
- Only use circular compact discs. Do not use non-circular promotional, etc. discs.

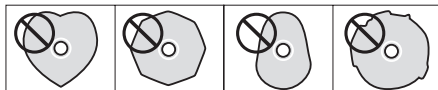

- Some record companies sell copy-protected discs or copy-controlled discs that may not play back correctly in this unit. Since such discs may not conform with the CD standard, do not use them in this unit.
- If you experience problems with such non-standard discs, you should contact the producers of the disc.

- In case of the failure of the Product caused by the tapes or other media ("Media") you used, the repair for the failure shall not be covered by the warranty of the Product and must be done at your own expense.
 - It is highly recommended that you shall avoid using the Media such as those not used for years or used after a long period of use or those with mold, blots, stickiness, folds, creases or twists.
 - TEAC shall never be responsible for any damages due to the Media including but not limited to the corruption or breakage of the Product or the Media, dragging the tapes into the Product, and/or loss of data in whole or in part that arises out of or related to the use of the Media. That is the same for any damages such as lost profit, indirect or consequential damages, and/or special damages.
- * It is highly recommended that you shall take appropriate measures to prepare for the unexpected loss of data along with the Copyright Act of your country or region.

Bluetooth overview

This unit has a built-in Bluetooth audio receiver, allowing it to output the audio playback of a computer or portable audio device that supports Bluetooth. In addition, this unit can be used to control the playback of such Bluetooth devices.

CAUTION

Operation and connection of this unit's Bluetooth functions with all Bluetooth devices are not guaranteed.

Transmission conditions

This is a Class 2 Bluetooth transmission output device. It has an approximate transmission range of 10 m, but this distance can vary due to the interference of obstacles and electromagnetic waves.

An obstacle between this unit and another Bluetooth device could interfere with Bluetooth transmission. If this occurs, remove the obstacle.

Moreover, the use of a wireless LAN (IEEE802.11b/g) or microwave oven in the same operating environment could also interfere with Bluetooth transmission. If this occurs, stop using that equipment or move this unit and the Bluetooth device at least 10 m away from it.

Profiles

This unit supports the following Bluetooth profiles.

- A2DP (Advanced Audio Distribution Profile)
- AVRCP (Audio/Video Remote Control Profile)

Bluetooth devices must support A2DP in order to transmit audio via Bluetooth.

Bluetooth devices must support AVRCP in order to enable playback control via Bluetooth.

Even if they have the same Bluetooth profile, however, different Bluetooth devices can have different functions depending on their specifications.

Codecs

This unit supports the following A2DP codecs and automatically selects one of them during audio transmission.

- SBC
- AAC
- Qualcomm®aptX™ audio

It will select the appropriate A2DP codec to use according to the codec support of the Bluetooth device and transmission conditions.

NOTE

You cannot use buttons, for example, to select the A2DP codec.

Due to the nature of Bluetooth wireless technology, playback from this unit will start slightly later than when triggered from the Bluetooth device.

Content protection

This unit supports SCMS-T content protection during audio transmission, enabling the playback of protected audio.

Transmission security

This unit supports security functions during Bluetooth transmission according to the Bluetooth standards, but the invisibility of transmission is not guaranteed.

Our company will take absolutely no responsibility if data is leaked during Bluetooth transmission.

2 – Names and functions of parts

Top panel

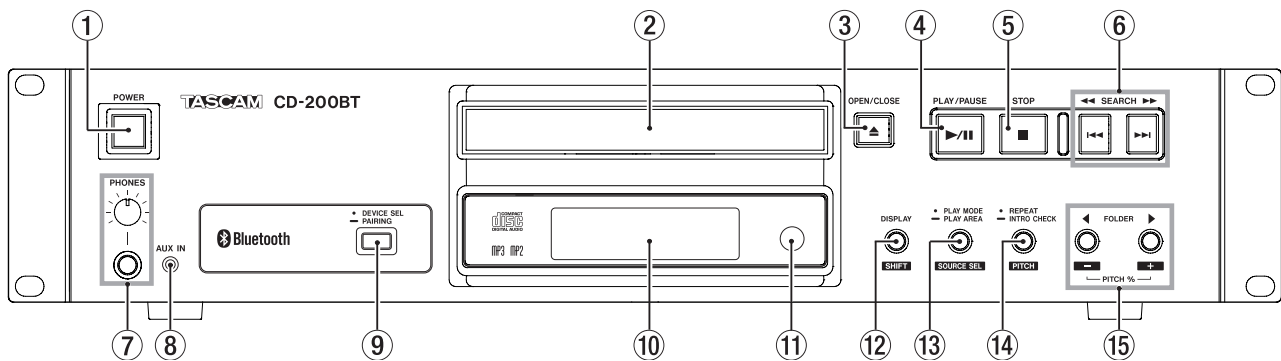

- ① **POWER switch**
Press this switch to turn the unit on or off.

CAUTION

- Before turning the power on, minimize the volume of connected equipment. Failure to do so could cause sudden loud noises, which might harm your hearing, for example.
- Do not wear headphones when turning the power ON/OFF. Noise could damage speakers or your hearing.

- ② **Disc tray**
Insert discs (CD, CD-R, CD-RW) here.
- ③ **OPEN/CLOSE button**
Use to open and close the disc tray.
- ④ **PLAY/PAUSE button**
Press during playback to pause. When playback is stopped or paused, press to start playback.
- ⑤ **STOP button**
Press this button to stop playback.
Press this button when editing a program to clear all items added to the program. (See “Setting the program” on page 20.)
- ⑥ **SEARCH ◀◀/▶▶ [◀◀/▶▶] buttons**
Press briefly to select tracks (skip). Press and hold to search a track.
- ⑦ **PHONES jack and knob**
Use this standard stereo jack to connect stereo headphones. Use a plug adapter when connecting headphones with mini-plugs. Use the **PHONES** knob to adjust the headphone output level.

CAUTION

Use the **PHONES knob** to minimize the volume before connecting headphones. Failure to do so could cause a sudden burst of loud noise, which might result in hearing damage, for example.

- ⑧ **AUX IN jack**
Use this stereo mini jack for line level audio input. Connect a portable digital audio player or other external audio device to it.

CAUTION

Before connecting an external device to the **AUX IN jack**, minimize the volume of that device. Failure to do so could result in sudden loud noises that could, for example, harm your hearing.

- ⑨ **DEVICE SEL/PAIRING button**
Press this button briefly to show the name of the device connected (or ready to be connected) by Bluetooth for two seconds. Press this button again briefly during this time to change the device to be connected by Bluetooth. (See “Searching for Bluetooth devices” on page 25.)
Press and hold this button to start Bluetooth pairing mode. Press this button when in pairing mode to end pairing mode. (See “Pairing” on page 25.)
- ⑩ **Display**
Displays various information.
- ⑪ **Remote Sensor**
When operating the remote control unit (RC-CD200BT), point it towards here.
- ⑫ **DISPLAY [SHIFT] button**
You can change the time and other information shown on this display.
When this button is pressed, the type of information currently displayed is shown for two seconds. Press the button again during this time to change the type of information shown. The information that can be shown depends on the current source, type of media and the status of operation. (See “Time and text information display” on page 23.) (See “Bluetooth information display” on page 26.)
Press this button at the same time as another button to use its shift function, which is shown as black letters on a white background beneath the button.

2 – Names and functions of parts

13 PLAY MODE/PLAY AREA [SOURCE SEL] button

Press briefly to change the playback mode.

The four playback modes are continuous, single, random and program. (See “Playback modes” on page 18.)

Press and hold this button to select ALL PLAY or FOLDER as the play area during data CD playback. (See “Setting the playback area” on page 18.)

Press this button while pressing and holding the **DISPLAY [SHIFT]** button to cycle through the current source options in the following order.

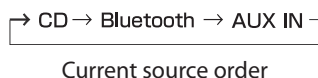

NOTE

AUX IN cannot be selected if nothing is connected to the AUX IN jack.

CAUTION

The playback mode and playback area settings can be changed when the current source is Bluetooth, but these settings have no effect on Bluetooth playback.

14 REPEAT/INTRO CHECK [PITCH] button

Press to turn the repeat playback function ON/OFF. (See “Repeat playback” on page 22.)

Press and hold this button during playback or when stopped to use the intro check playback function. The first 10 seconds of each track on the CD will be played back one after the other. During intro check playback, press and hold this button again to return to the previously active playback mode and continue playing back the current track. (See “Intro Check function” on page 24.)

While pressing and holding the **DISPLAY [SHIFT]** button, press this button to turn the CD playback pitch control function ON/OFF. (See “Pitch control” on page 24.)

CAUTION

The repeat setting can be changed when the current source is Bluetooth, but this setting has no effect on Bluetooth playback. Moreover, when using Bluetooth the intro check function cannot be used.

15 FOLDER ◀/▶ [PITCH -/+] buttons

Use these buttons when the current source is a CD and the playback area is FOLDER to change the playback folder. (See “Setting the playback folder” on page 20.)

Use these buttons when the current source is a CD and the playback area is ALL PLAY to skip between folders.

Press this button while pressing and holding the **DISPLAY [SHIFT]** button to set the pitch control value. (See “Pitch control” on page 24.)

Rear panel

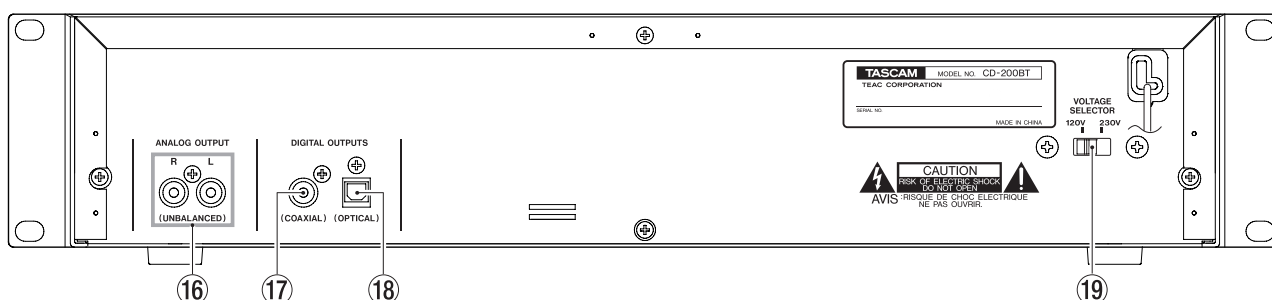

16 ANALOG OUTPUT (UNBALANCED) jacks

These jacks output analog signals (Standard output: -10 dBV) of the CD or Bluetooth playback signal or the signal input through the **AUX IN** jack.

17 DIGITAL OUTPUTS (COAXIAL) jack

This jack outputs the CD playback signal in S/PDIF digital format.

18 DIGITAL OUTPUTS (OPTICAL) jack

This jack outputs the CD playback signal in S/PDIF digital format.

19 VOLTAGE SELECTOR

Switches the voltage to either **230 V** or **120 V**.

NOTE

- *The voltage selector is only available on units for specific markets.*
- *In North America, use only on 120V supply.*

NOTE

- *Audio from Bluetooth playback and audio input through the AUX IN jack can only be output as analog signals. These audio sources cannot be output as digital signals.*
- *The sampling frequency of this unit's digital output is always 44.1 kHz regardless of the playback file sampling frequency.*
- *Digital output is possible when the pitch control function is on with CD, but the sampling frequency is changed by an amount proportional to the pitch control value.*

2 – Names and functions of parts

Display

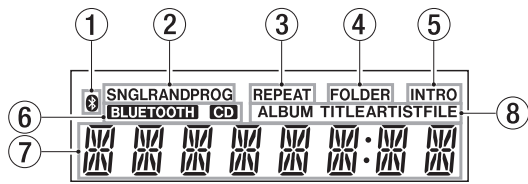

- ① **Bluetooth icon**
Shows the status of connection with a Bluetooth device.

Indicator	Meaning
Blinking	Unconnected
Lit	Connected
Blinking rapidly	Currently pairing

- ② **Playback mode indicator**
This shows the current playback mode.

Indicator	Playback mode
None	Continuous playback mode
SNGL	Single playback mode
RAND	Random playback mode
PROG	Program playback mode

- ③ **REPEAT indicator**
REPEAT appears when the repeat playback function is ON.
- ④ **FOLDER indicator**
FOLDER appears when the playback area is set to FOLDER.
- ⑤ **INTRO indicator**
INTRO appears when the intro check function is ON.
- ⑥ **Current source indicator**
This shows the current source.

Indicator	Current source
CD	CD
BLUETOOTH	Bluetooth
None	AUX (-AUX- appears in the main display area)

- ⑦ **Main display area**
The track number and time or text information is shown. The status of the unit (OPEN, CLOSE, TOC* READ, etc.) and messages (NO DISC, etc.) are also shown. Items with more than eight characters are scrolled when shown.
* TOC means "Table Of Contents," which is track information written on the disc

- ⑧ **Main display information type indicator**
When text information is shown in the main display area, these indicate the type of information.

Indicator	Meaning
ALBUM TITLE	CD-TEXT album title or current folder name
ALBUM ARTIST	CD-TEXT album artist
TITLE	CD-TEXT track title or track title of the current file (from its tag data)
ARTIST	CD-TEXT track artist or track artist of the current file (from its tag data)
FILE	Current file name

Remote control unit (TASCAM RC-CD200BT)

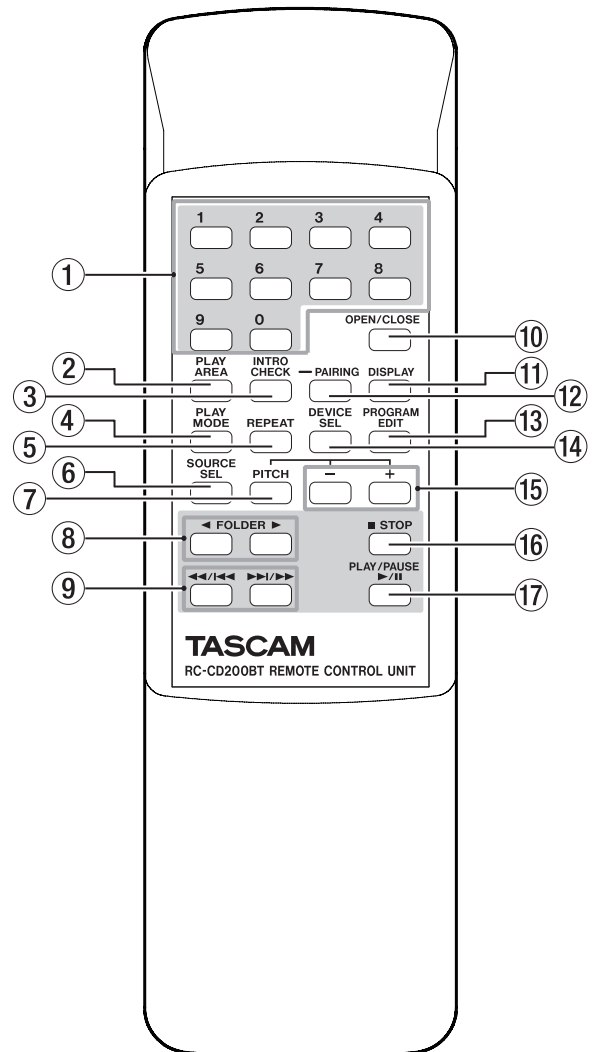

- ① **Number (0-9) buttons**
Use these buttons to input numbers for track selection. (See "Selecting by track number" on page 19.)
Track numbers have a maximum of 2 characters for audio CDs and a maximum of 3 characters for a data CDs.
- ② **PLAY AREA button**
Press to set the playback area of data CDs to ALL PLAY or FOLDER. (See "Setting the playback area" on page 18.)
- ③ **INTRO CHECK button**
Use for intro check playback. The first 10 seconds at the beginnings of tracks on the CD will be played back one after another.
During intro check playback, press this button again to return to ordinary playback mode. (See "Intro Check function" on page 24.)

2 – Names and functions of parts

④ **PLAY MODE button**

Press to change the playback mode.

The four playback modes are continuous, single, random and program. (See “Playback modes” on page 18.)

CAUTION

The playback mode, playback area, and repeat settings can be changed when the current source is Bluetooth, but these settings have no effect on Bluetooth playback. Moreover, when using Bluetooth the intro check function cannot be used.

⑤ **REPEAT button**

Press to turn the repeat playback function ON/OFF. (See “Repeat playback” on page 22.)

⑥ **SOURCE SEL button**

Change the current source in the following order. (See “Selecting the audio to output (current source)” on page 16.)

→ CD → Bluetooth → AUX IN →

Current source order

NOTE

AUX IN cannot be selected if nothing is connected to the AUX IN jack.

⑦ **PITCH button**

Press this button to turn the CD playback pitch control function ON/OFF. (See “Pitch control” on page 24.)

⑧ **FOLDER ◀/▶ buttons**

Use these buttons when the playback area is set to **FOLDER** to change the playback folder. (See “Setting the playback folder” on page 20.)

Use these buttons when the playback area is set to **ALL PLAY** to skip between folders.

⑨ **◀◀/▶▶ and ▶▶/◀◀ buttons**

Press briefly to select tracks (skip). Press and hold to search a track.

⑩ **OPEN/CLOSE button**

Use to open and close the disc tray.

⑪ **DISPLAY button**

Press to change how the time is shown and other information. When this button is pressed, the type of information currently displayed is shown for two seconds. Press the button again during this time to change the type of information shown. The information that can be shown depends on the current source, type of disc and status of operation. (See “Time and text information display” on page 23.) (See “Bluetooth information display” on page 26.)

⑫ **PAIRING button**

Press and hold this button to start Bluetooth pairing mode. Press this button when in pairing mode to end pairing mode. (See “Pairing” on page 25.)

⑬ **PROGRAM EDIT button**

Use to set, confirm and edit programs. (See “Programmed playback” on page 20.)

⑭ **DEVICE SEL button**

The name of the device connected (or ready to be connected) by Bluetooth is shown for two seconds. Press this button again during this time to change the device to be connected by Bluetooth. (See “Searching for Bluetooth devices” on page 25.)

⑮ **–/+ buttons**

Use these adjust the pitch control value during CD playback. (See “Pitch control” on page 24.)

⑯ **STOP button**

Press this button to stop playback.

Press this button when editing a program to clear all items added to the program. (See “Setting the program” on page 20.)

⑰ **PLAY/PAUSE button**

Press during playback to pause. When playback is stopped or paused, press to start playback.

3 – Preparations

Making connections

Examples of connections that can be made with a CD-200BT are shown below.

■ Precautions before making connections

- Before connecting other devices, read their operation manuals carefully and connect them properly.
- Turn the power OFF or set the power to standby for this unit and all units to be connected to it.
- Set up all the units so that they are powered from the same line. When using a power strip, for example, use a thick cable with a high current capacity to reduce fluctuation of the power voltage.

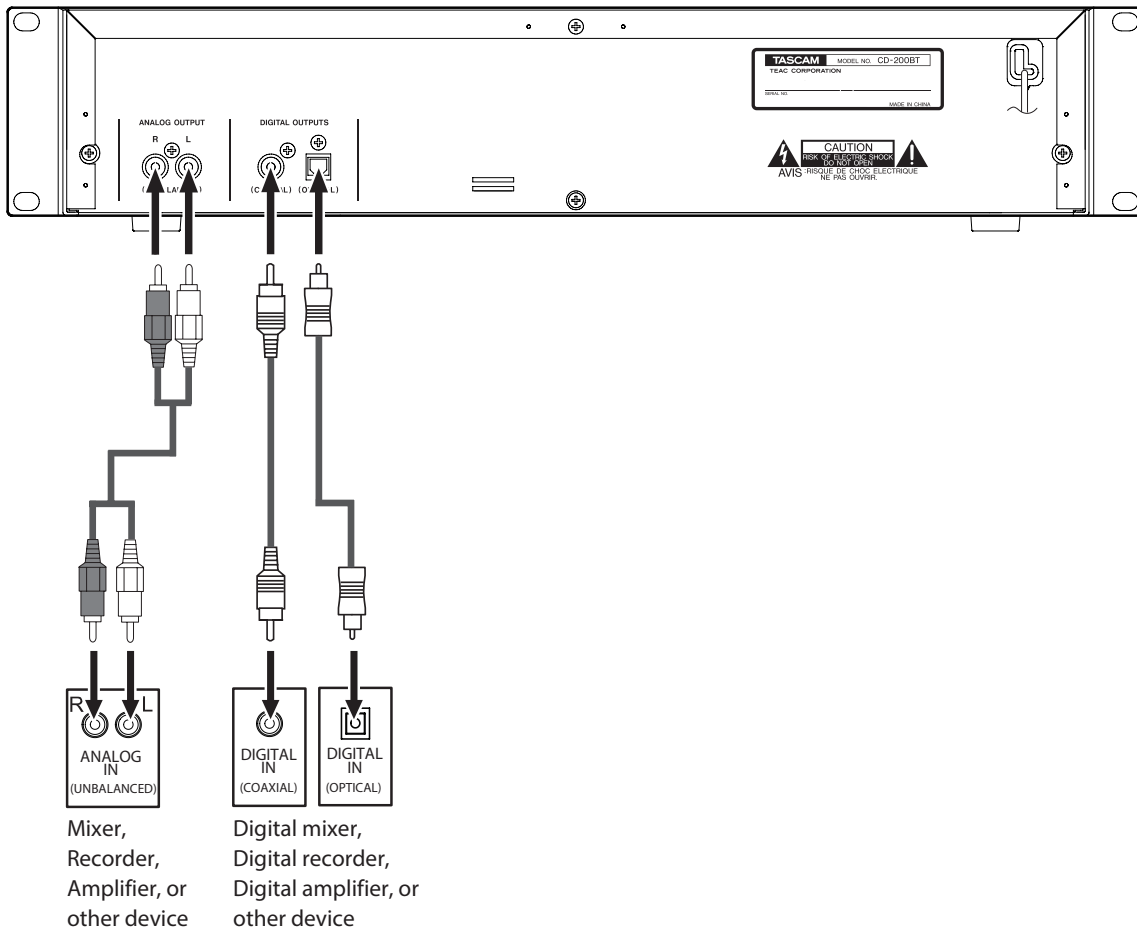

■ Connecting analog audio devices

Connect the analog output jacks of this unit to the input jacks of a stereo amplifier, mixer, recorder or other device with analog inputs.

NOTE

- Cables are not included with this unit.
- Do not bundle RCA cables with power cords or speaker cables. Doing so could cause reduced audio quality or noise.

■ Connecting digital audio devices

Connect a digital output jack (coaxial or optical) of this unit to the input jack of a stereo amplifier, mixer, recorder or other device with a digital input.

NOTE

- Bluetooth audio playback signals and AUX IN input signals can only be output from the analog jacks. They cannot be output from the digital connectors.
- The sampling frequency of this unit's digital output is always 44.1 kHz regardless of the playback media/file sampling frequency.
- During playback of CD, digital output is possible when the pitch control function is in use, but the sampling frequency is changed by an amount equivalent to the pitch control value. When the pitch control function is on, some devices might not be able to accept signals from the digital outputs of this unit.

Connecting a device to the AUX IN jack

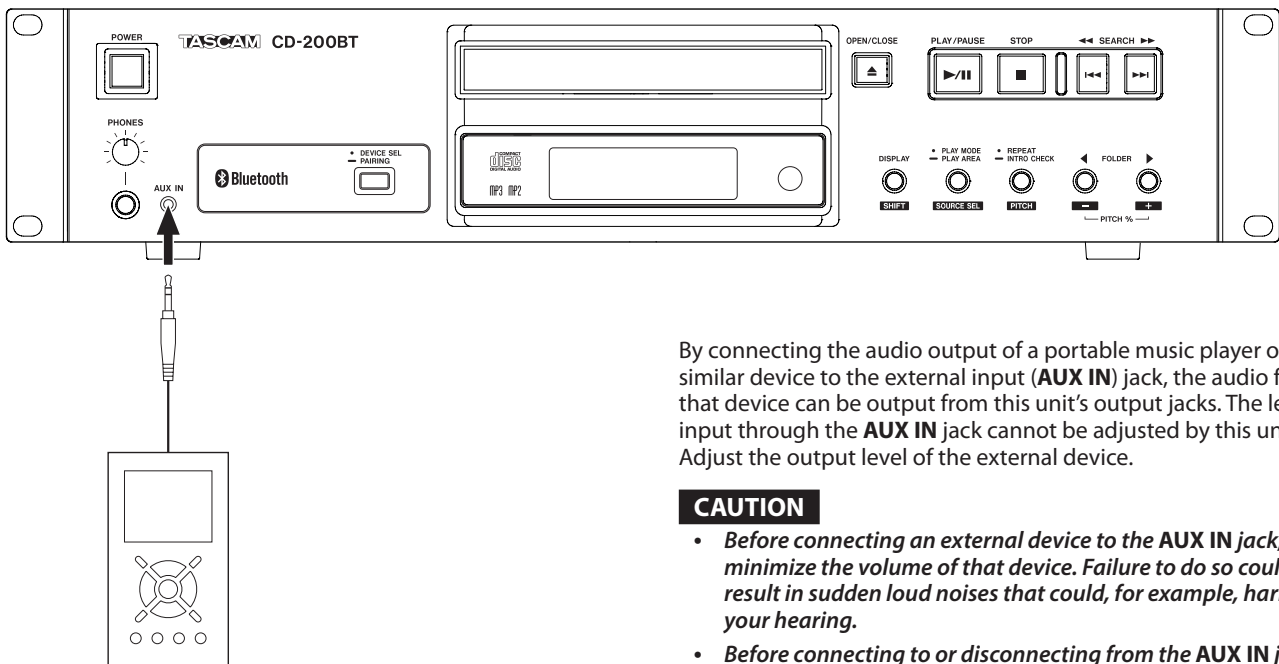

By connecting the audio output of a portable music player or similar device to the external input (**AUX IN**) jack, the audio from that device can be output from this unit's output jacks. The level input through the **AUX IN** jack cannot be adjusted by this unit. Adjust the output level of the external device.

CAUTION

- Before connecting an external device to the **AUX IN** jack, minimize the volume of that device. Failure to do so could result in sudden loud noises that could, for example, harm your hearing.
- Before connecting to or disconnecting from the **AUX IN** jack, change the current source to something other than **AUX IN** (CD or Bluetooth), or turn this unit off.

Preparing the remote control

Inserting batteries

1. Open the lid.

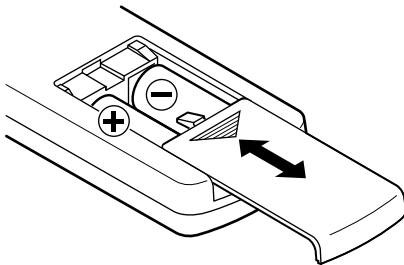

2. Confirm +/- polarity, and insert two AA batteries.
3. Close the lid.

Replacing the batteries

Replace both batteries with new ones when the range of the remote control becomes short or if the function buttons become unresponsive.

Cautions about the use of batteries

Misuse of batteries could cause them to leak, rupture or otherwise be damaged. Please read and abide by the precautions on them when using batteries. Also see "CAUTIONS ABOUT BATTERIES" on page 4.

Cautions about using the remote control

- When using other devices controlled by infrared rays, use of this remote control might operate these devices by mistake.
- Use the remote control within the following range.

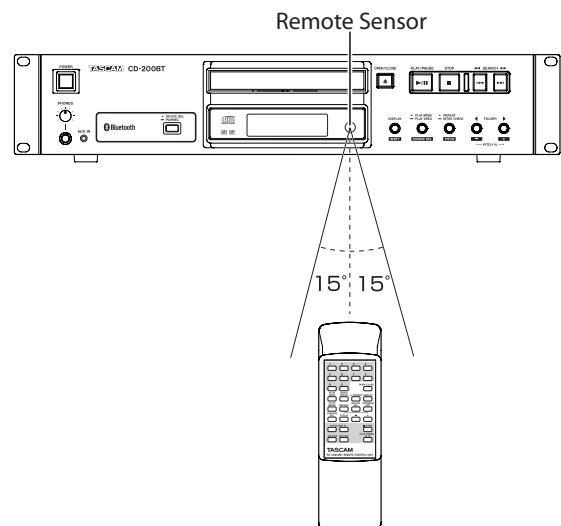

Operation distance
 Directly in front: Within 7 meters
 15° left or right: Within 7 meters

3 – Preparations

Loading a CD

To load a CD, press the **OPEN/CLOSE** button on the main unit or on the remote control to open the disc tray, and put the CD into the tray with the label facing up.

Press the **OPEN/CLOSE** button again to close the disc tray. After loading the disc, the unit reads the disc's information and the display shows the total number of tracks and total playback time if it is an audio CD or the total number of tracks in the current folder or on the entire disc if it is a data CD.

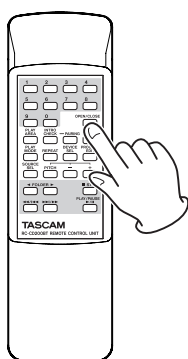
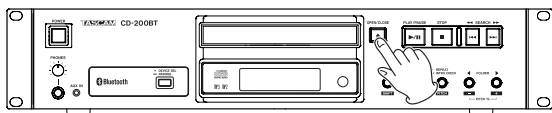

NOTE

- When the current source is set to CD, instead of pressing the **OPEN/CLOSE** button to close the disc tray, you can press the **PLAY/PAUSE** button to close the disc tray and begin playback immediately.
- If you open the disc tray while this unit is in use, the following settings are lost.
 - Program
 - Current folder (for data CDs)

Selecting the audio to output (current source)

You can select the CD playback signal, the audio signal received via Bluetooth or the signal input through the **AUX IN** jack as the audio signal output from this unit.

Press the **PLAY MODE/PLAY AREA [SOURCE SEL]** button while pressing and holding the **DISPLAY [SHIFT]** button on this unit, or press the **SOURCE SEL** button on the remote control to cycle through the current source options as shown below.

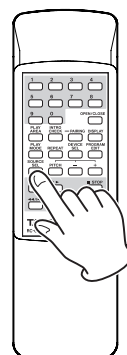
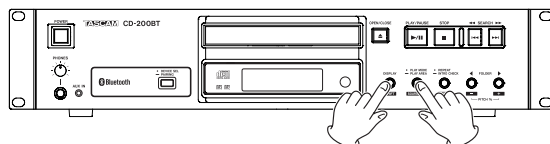

Cycle through the current source options in the following order.

→ CD → Bluetooth → AUX IN

Current source order



Display when current source is CD



Display when current source is Bluetooth



Display when current source is AUX IN

NOTE

- **AUX IN** cannot be selected if nothing is connected to the **AUX IN** jack.
- When the current source is changed from CD to Bluetooth, the CD will stop if playing back or paused. When the current source is changed from Bluetooth to AUX IN or CD, playback of the connected Bluetooth device will stop.
- Even if the current source is changed, the CD playback mode, current folder and program contents will not be erased.

4 – CD playback

In this chapter, we explain playback functions that can be used with tracks on CDs.

The following explanations assume that a CD that contains audio files/tracks has been loaded in this unit, the power is ON and the CD has been set as the current source. (See “Selecting the audio to output (current source)” on page 16.)

Playable discs and files

This unit can play back the following types of discs and files.

■ CD-DA (audio CD) format discs

Music CDs that are commercially available and CD-R and CD-RW discs that have been recorded as audio CD format can be played. In this manual, these types of discs are called “audio CDs.”

■ Data CDs

This unit can play back CD-ROM/R/RW discs with MP3, MP2 and WAV files in ISO 9660 Level 1, Level 2 and Joliet formats. In this manual, these types of discs are called, “data CDs.”

NOTE

- This unit cannot read CD-R/RW discs that have not been finalized.
- For details about playable sampling frequencies and bit rates, see “Playback file formats” on page 29.
- The sampling frequency of this unit’s digital output is always 44.1 kHz regardless of the playback disc/file sampling frequency. Digital output is possible when pitch control is ON, but the sampling frequency is altered in proportion to the pitch control value. When the pitch control function is ON, therefore, some equipment might not be able to receive the digital output of this unit.
- This unit’s display can only show single-byte characters (alphabet and numbers). File with names that use Japanese, Chinese or other double-byte characters can be played back, but those characters will be shown as _ on the display.
- This unit identifies MP3 and MP2 files by their “.mp3” and “.mp2” file extensions. This unit cannot play MP3/MP2 files that do not have the correct “.mp3” and “.mp2” file extension, so always include these file extensions at the ends of MP3/MP2 file names. This unit cannot play files that are not in the MP3/MP2 data format even if they have an “.mp3” and “.mp2” file extension.
- The unit identifies WAV files with the “.wav” file extension. This unit cannot play WAV files that do not have the “.wav” file extension, so always include the “.wav” file extension at the end of the name of an WAV file. The unit cannot play files that are not in the WAV data format even if they have the “.wav” file extension.
- Data CDs with more than 999 files or 512 folders might not play correctly.
- Depending on disc conditions, this unit might not be able to play some discs, or skips in the sound might occur.

Folders and tracks on data CDs

This unit treats all the audio files on data CDs as “tracks”. Some data CDs store files inside folders in the same way that computers usually do. In addition, multiple folders can be stored inside another folder creating a multilevel structure. (The maximum number of folder levels is 16.)

You can use this unit’s folder search function to look for audio files among multiple folders. Searching starts from high-level folders and then moves to lower-level subfolders.

If there are audio files in the root directory of a data CD, this root directory is also treated as a folder.

Folders that do not directly contain audio files will be ignored when searching folders. For example, folders C and D in the illustration below would be ignored when searching folders.

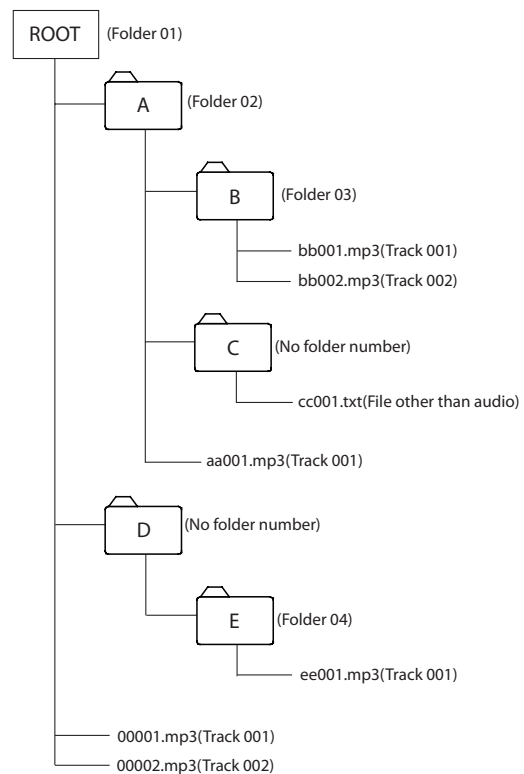

Example of data CD structure

4 – CD playback

Playback area

With data CDs, you can set the area to be used for playback (PLAY AREA setting). Follow the procedures below to set the playback area.

Setting the playback area

Press and hold the **PLAY MODE/PLAY AREA [SOURCE SEL]** button on the main unit or press the remote control **PLAY AREA** button to set the playback area.

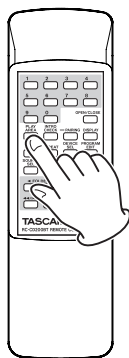
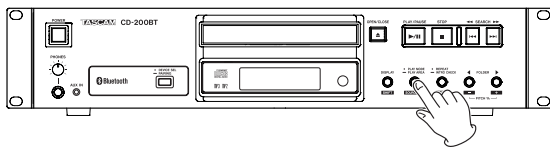

The selected playback area is shown as follows in the main display area for about two seconds and then disappears. Depending on the selected playback area, the **FOLDER** indicator might also appear on the display.

Main display area	FOLDER indicator	Meaning
ALL PLAY	Not shown	All files on the data CD will be played back.
FOLDER	Shown	All files in the selected folder on the data CD will be played back.

Playback modes

This unit can play back tracks using the following four playback modes.

Continuous playback mode (default setting)

Tracks on the CD are played back in numerical order.

NOTE

When FOLDER is the playback area for a data CD, the tracks in the current folder will be played back in numerical order.

Single playback mode

The selected track on the CD is played back once and then playback stops.

Random playback mode

The tracks on the CD are played back in random order regardless of their track numbers. Playback stops after all tracks have been played.

NOTE

When FOLDER is the playback area for a data CD, the tracks in the current folder will be played back in random order. (See "Folder playback (data CDs)" on page 20.)

Program playback mode

The programmed tracks are played back in program order. See "Programmed playback" on page 20 for details.

Selecting the playback mode

Press the main unit **PLAY MODE/PLAY AREA [SOURCE SEL]** button or the remote **PLAY MODE** button to cycle through the playback modes. During playback, however, you can only switch among continuous, single and random playback modes.

To select programmed playback, press the main unit **PLAY MODE/PLAY AREA [SOURCE SEL]** button or the remote **PLAY MODE** button when playback is stopped.

The currently selected playback mode is shown on the display as follows.

Indicator	Playback mode
No indicator	Continuous playback mode
SNGL	Single playback mode
RAND	Random playback mode
PROG	Program playback mode

The selected playback mode is retained even when the power is turned off.

NOTE

*Immediately after pressing the **PLAY MODE/PLAY AREA [SOURCE SEL]** button on the main unit or the **PLAY MODE** button on the remote control, the selected mode is shown on the main display area as follows.*

<i>Continuous playback mode set:</i>	CONTINUE
<i>Single playback mode set:</i>	SINGLE
<i>Random playback mode set:</i>	RANDOM
<i>Programmed playback mode set:</i>	PROGRAM

Playback

The following procedures assume that the necessary connections have been completed, the unit's power has been turned ON and CD has been loaded.

To start playback, press the **PLAY/PAUSE** button on the main unit or the remote control.

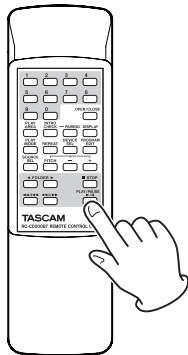
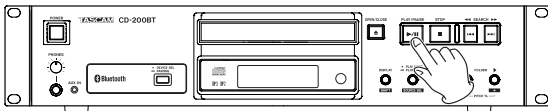

■ Stopping playback

Press the **STOP** button on the main unit or the remote control.

■ Pausing playback

Press the **PLAY/PAUSE** button on the main unit or the remote control.

In this manual, unless stated otherwise, explanations are given assuming that the playback mode is continuous. (See "Playback modes" on page 18.)

Selecting a track

There are two ways to select a track. You can move (skip) to the previous or next track, or you can select a track directly by its track number.

Skipping to the next or previous track

Use the main unit **SEARCH** \lll/\ggg [\lll/\ggg] buttons or the remote search (\lll/\lll and \ggg/\ggg) buttons to skip to tracks.

After selecting the track, press the **PLAY/PAUSE** button on the main unit or the remote control to start track playback.

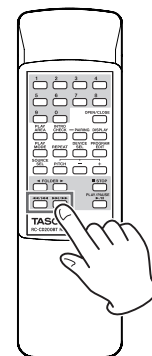
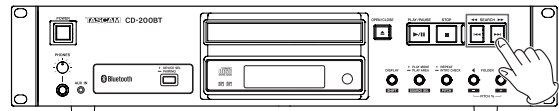

NOTE

*If you press the main unit **SEARCH** \lll/\ggg buttons or the remote search (\lll/\lll and \ggg/\ggg) buttons during playback, playback will resume after skipping tracks.*

Selecting by track number

Use the number (0–9) buttons on the remote control to directly select tracks for playback.

Track numbers can have up to two digits for audio CDs and up to three digits for data CDs.

- Use the number (0–9) buttons on the remote control to input the track number. Enter the track number starting from the largest digit.
 - To select track 1:**
Press the **1** button one time.
 - To select track 12:**
Press the **1** button followed by the **2** button.
- Press the **PLAY/PAUSE** button on the main unit or the remote control. The selected track begins to play. If you press the **STOP** button on the main unit or the remote control, the display stops showing the track number input and the display returns to its previous state.

NOTE

- When the playback area is set to ALL PLAY, use the **FOLDER** \lll/\ggg buttons on the main unit or the remote control to skip between folders.*
- When in program or random mode, you cannot use the number (0–9) buttons to select tracks.*

4 – CD playback

Search forward and backward

You can search forward and backward in a track while listening to it.

1. Play or pause the desired track.
2. Press and hold a **SEARCH** ◀◀/▶▶ [◀◀/▶▶] button on the main unit or a search (◀◀/▶▶ or ▶▶/▶▶) button on the remote control to start searching forward or backward.
3. Release the button that you are holding to stop searching and return the unit to the state it was in before searching (playback or pause).

NOTE

Searching forward and backward is possible with data CDs.

Folder playback (data CDs)

With data CDs, you can set the selected folder (current folder) as the playback area. Follow the procedures below to set the playback folder. You can also set the playback area to be all the tracks/files on the CD by selecting **ALL PLAY**.

Setting the playback folder

1. Press and hold the **PLAY MODE/PLAY AREA [SOURCE SEL]** button on the main unit or press the remote **PLAY AREA** button to set the playback area to **FOLDER**.
2. Use the main unit **FOLDER** ◀/▶ [PITCH -/+] buttons or the remote **FOLDER** ◀/▶ buttons to skip to the previous or next folder.

This will skip to the beginning of the first track in the previous or next folder. If you hold down one of these buttons, you can skip through folders continuously in order.

NOTE

- *When you skip to a different folder, it becomes the current folder.*
- *During folder playback, repeat playback will play back all tracks inside the current folder repeatedly.*
- *During folder playback, random playback will play back all tracks inside the current folder randomly.*

Programmed playback

To use programmed playback, you must set a program either before or after setting the playback mode to programmed playback mode. (See “Selecting the playback mode” on page 18.)

When in programmed playback mode, press the **PLAY/PAUSE** button on the main unit or the remote control to start playback of the set program in order from the first track (program step 01).

Press the main unit **SEARCH** ◀◀/▶▶ [◀◀/▶▶] button or the remote search (◀◀/▶▶ or ▶▶/▶▶) button to skip to the previous or next program step.

When playback is stopped in program playback mode using an audio CD, the total number of tracks in the program and the total program time are shown.

When using a data CD, only the program number is shown.

NOTE

- *To select programmed playback, when stopped, press the main unit **PLAY MODE/PLAY AREA [SOURCE SEL]** button or the remote **PLAY MODE** button.*
- *With data CDs, you cannot set a program when the playback area is **ALL PLAY**. Change the playback area to **FOLDER** to enable tracks in the current folder to be used in the program.*

Setting the program

When no program is set, follow the procedures below to set a program using the remote control.

NOTE

- *The program cannot be set from the main unit.*
 - *You can set a program at any time regardless of the current playback mode.*
 - *CD programs are cleared when the disc tray is opened or the current folder is changed.*
1. Press the remote **PROGRAM EDIT** button when playback is stopped.

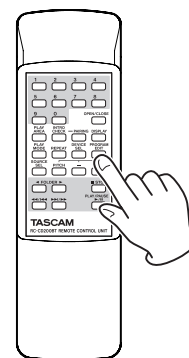

The unit enters program setting mode. If no program has been set, it will be possible to choose a track for program step 01 (PROG indicator blinks).



Audio CD example

4 – CD playback

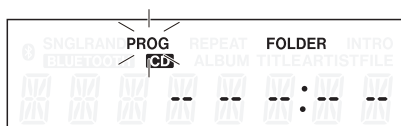

Data CD example

NOTE

If the program is already set, the track number of the track set as program step 01 is shown.

- Use the remote number (0–9) buttons or search (◀◀/▶▶ and ▶▶/▶▶) buttons to select a track to set as program step 01 (PROG and the track number blink). Use the number (0–9) buttons to input the number starting with the largest digit.



Track number Playback time

Audio CD example

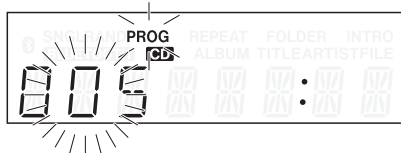

Data CD example

NOTE

- When using a data CD, the screen switches to file name display if more than a second passes after pressing one of the remote number (0–9) or search (◀◀/▶▶ and ▶▶/▶▶) buttons, but you can still add the track to the program.
 - If you press the STOP button while a track is selected, selection of that track is canceled, and the screen returns to the state where you can select a track.
- Press the remote PROGRAM EDIT button to add the selected track as program step 1.



- The unit is now ready for you to add another track as the next program step.
- If you are finished adding tracks to the program, press the remote PROGRAM EDIT button when the empty program step is shown. The unit exits program setting mode.

NOTE

- The same track can be added to the program multiple times.

- If you press the STOP button when the empty program step where it is possible to add a track appears, all steps in the program are cleared.
- If you try to add more than 99 tracks, a PGM FULL error message appears. Only 99 tracks can be added.

Checking the program

You can check the contents of the program.

- Press the PROGRAM EDIT button on the remote control while playback is stopped to put the unit into program setting mode. The track number and playback time of the track set as program step 01 is shown on the screen and PROG blinks. (Program step number is displayed instead of playback time when using a data CD.)

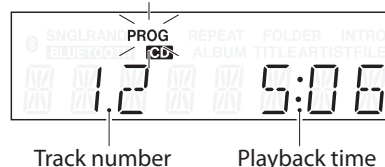

Track number Playback time

- Press the PROGRAM EDIT button to show the track information of the next program step.



- If you press the PROGRAM EDIT button when the final program step is shown, it becomes possible to add another program step. (No track number is shown and PROG blinks.)

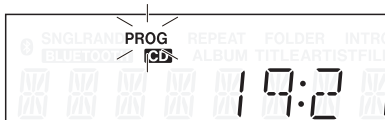

- Press the PROGRAM EDIT button again to exit the program setting mode.

Replacing a program track

You can replace a track that has already been added to the program.

- Press the PROGRAM EDIT button on the remote control while playback is stopped to put the unit into program mode.
- Follow the steps in "Checking the program" above and press the PROGRAM EDIT button to show the program step with the track that you want to replace.
- Use the remote number (0–9) buttons or skip (◀◀/▶▶ and ▶▶/▶▶) buttons to select the desired track and press the PROGRAM EDIT button. After replacing a track, the display shows the empty step at the end of the program and you can add another track to the end of the program if desired.
- Press the PROGRAM EDIT button again to exit program setting mode.

4 – CD playback

Adding more program tracks

You can add tracks to the end of an already set program.

1. Press the **PROGRAM EDIT** button on the remote control while playback is stopped to activate program setting mode.
2. Press and hold the **PROGRAM EDIT** button until the empty program step where it is possible to add a track appears. (No track number is shown and **PROG** blinks.)
3. Use the remote number (**0–9**) buttons or skip (**◀◀/▶▶** and **▶▶/▶▶**) buttons to select the track to add and press the **PROGRAM EDIT** button.
4. In this state, you can repeat step 3 to add more tracks, or you can press the **PROGRAM EDIT** button to exit program setting mode.

CAUTION

- Although tracks can be added to the end of a program and tracks can be replaced with different tracks, tracks cannot be inserted into the middle of a program.
- If you want to insert a track into the middle of the program, replace and add program tracks to alter the program contents.

Clearing the program

You can clear the entire program that has been set.

1. Press the **PROGRAM EDIT** button on the remote control while playback is stopped to activate program setting mode.
2. Press and hold the **PROGRAM EDIT** button until the empty program step where it is possible to add a track appears. (No track number is shown and **PROG** blinks.)
3. Press the remote **STOP** button.
–**CLEAR**– appears on the display. After clearing completes, program setting mode resumes with the empty program.



In addition to the above procedure, opening the disc tray or changing the current folder also clears the program.

Repeat playback

You can play back all the tracks in the playback area repeatedly.

Press the main unit **REPEAT/INTRO CHECK [PITCH]** button or the remote **REPEAT** button to turn the repeat playback function ON/OFF.

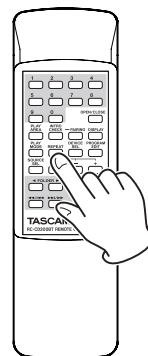
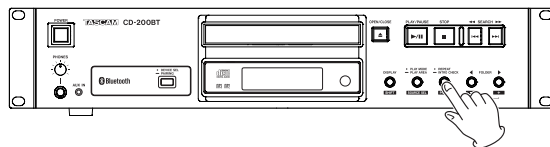

Repeat ON (REPEAT indicator appears)

All tracks are played back repeatedly.



Repeat OFF (no indicator)

Repeat playback is OFF.



NOTE

- With data CDs, during folder playback all tracks within the current folder will be played back repeatedly. During program playback, all tracks within the program will be played back repeatedly.
- If the repeat playback function is turned ON during playback, playback continues as is until the end and then playback continues from the beginning.
- If repeat playback is turned ON when stopped, repeat playback begins when the **PLAY/PAUSE** button is pushed.
- The repeat playback function's ON/OFF state is retained even when the power is turned OFF.

Time and text information display

You can set what type of time and text information is shown on the display.

Press the **DISPLAY [SHIFT]** button on the main unit or the **DISPLAY** button on the remote control to show for two seconds the type of information (playback time or text information) that is currently set to appear in the main area of the display. Press this button again while this is being shown to change the type of information displayed.

The types of data that can be shown when changing the display depend on the type and status of the current source or loaded disc, as well as this unit's operation status.

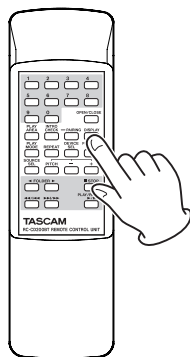
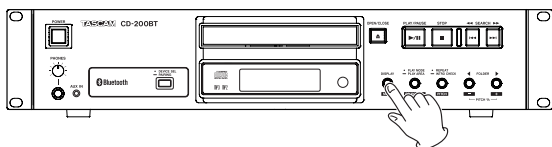

■ Audio CDs with CD text

When playing back or paused, you can change the information shown on the display, cycling through track elapsed time, track remaining time, total remaining time, track title and track artist.

When stopped, you can also change the information shown, but the album title, album artist and total number of tracks and total playback time are shown.

■ Audio CDs without CD text

When playing back or paused, you can change the information shown on the display, cycling through track elapsed time, track remaining time and total remaining time.

When stopped, you can also change the information shown, but the total number of tracks and total playback time are shown.

■ Data CD

When playing back or paused, you can change the information shown on the display, cycling through track elapsed time, track title, track artist and file name.

When stopped, you can still change the display mode from the track elapsed time to the album title.

When stopped, you can switch to the album title (current folder).

NOTE

- For details about display when the current source is Bluetooth, see "Bluetooth information display" on page 26.
- After pressing the **DISPLAY [SHIFT]** button on the main unit or the **DISPLAY** button on the remote control, the currently selected type of information to be shown on the main display appears for two seconds as follows.

Track elapsed time: ELAPSED
 Track remaining time: REMAIN
 Total remaining time: T REMAIN
 Album/track title: TITLE
 Album/track artist: ARTIST
 File name: FILENAME

- The text information shown on the display is CD text information for audio CDs and ID3 tag information for data CDs. When information is not included for a disc or file, NO TITLE (title information) or NO NAME (artist information) is shown. If the information contains characters that cannot be displayed, those characters are replaced by _.
- When an audio CD is in programmed playback mode the elapsed time and remaining time of the entire program is shown.
- The display contents setting is retained even when the power is turned off.

4 – CD playback

Pitch control

Using pitch control playback, CDs can be played back at a different pitch (sound frequency and playback speed). Follow the procedures below to use pitch control playback.

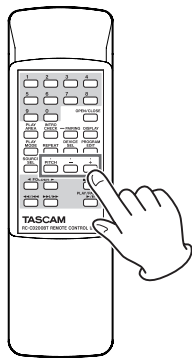
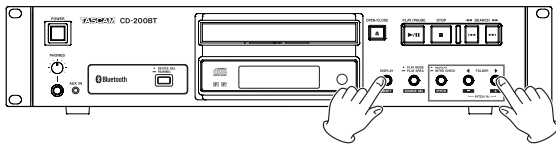

1. Press the **REPEAT/INTRO CHECK [PITCH]** button while pressing and holding the **DISPLAY [SHIFT]** button on the main unit or press the **PITCH** button on the remote control to turn pitch control ON. The current pitch control value is shown at this time.



2. Use the **FOLDER ◀/▶ [PITCH -/+]** buttons while pressing and holding the **DISPLAY [SHIFT]** button on the main unit or use the **PITCH -/+** button on the remote control to set the pitch in 0.5% units in a range of $\pm 14.0\%$.

■ To turn pitch control playback OFF:

Press the **REPEAT/INTRO CHECK [PITCH]** button while pressing and holding the **DISPLAY [SHIFT]** button on the main unit or press the **PITCH** button on the remote control.



NOTE

- During playback, turning pitch control playback ON or OFF might cause the playback sound to skip momentarily.
- Using pitch control playback with a data CD (MP3, MP2, WAV) sometimes causes the playback sound to skip.
- When the pitch control function is on, digital output is possible, but the sampling frequency will be changed by an amount equivalent to the pitch control value. When the pitch control function is on, some devices might not be able to receive this unit's digital output.
- The pitch control function cannot be used with Bluetooth.

Intro Check function

When stopped or during playback press and hold the main unit **REPEAT/INTRO CHECK [PITCH]** button or press the remote **INTRO CHECK** button to play the first 10 seconds of each track one after another. The **INTRO** indicator appears when this function is active.

During intro check playback, press and hold the **REPEAT/INTRO CHECK [PITCH]** button on the main unit or the **INTRO CHECK** button on the remote to return to ordinary playback mode (**INTRO** disappears from the display).

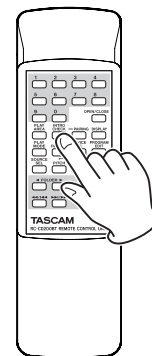
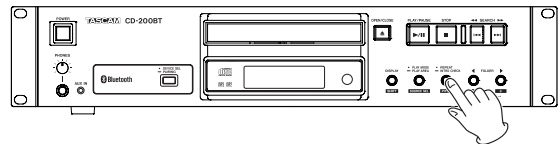

- When using Intro Check, briefly press the main unit **SEARCH** ◀/▶ [◀◀/▶▶] buttons or the remote search (◀◀/▶▶ and ▶▶/◀◀) buttons to skip to the preceding or next track.
- Press the **STOP** button to stop Intro Check.
- The intro check function can be used during program and folder playback modes.

CAUTION

The intro check function cannot be used with Bluetooth.

5 – Bluetooth device playback

This unit can output audio from a computer, portable audio device or other equipment (Bluetooth device) that supports Bluetooth (A2DP). Moreover, if the Bluetooth device supports AVRCP, you can use this unit's **PLAY/PAUSE** button, for example to control playback of the Bluetooth device

Pairing

Following these procedures to pair with a Bluetooth device in order to communicate with it.

NOTE

Pairing also requires operating the Bluetooth device. For instructions about how to do this, refer to the operation manual for the Bluetooth device you are using.

1. Press and hold the **DEVICE SEL/PAIRING** button on the main unit, or press and hold the **PAIRING** button on the remote control.

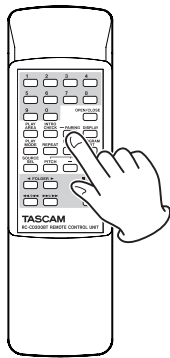
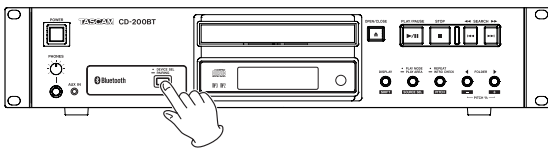

When you do this, **PAIRING** appears blinking on the display, and the  icon blinks rapidly.



2. Prepare the Bluetooth device for Bluetooth transmission.
3. Select this unit (CD-200BT) from the Bluetooth device.

When pairing succeeds, **PAIRED** appears on the display and the unit is connected to that device.

NOTE

- After pairing once, pairing again is not necessary. The paired Bluetooth device will be detected and connect automatically.
- This unit can store pairing data for a maximum of 8 devices. If more than 8 devices are paired the oldest pairing data will be overwritten with newer data.
- While pairing, press the **DEVICE SEL/PAIRING** button on the main unit or the **PAIRING** button on the remote control to cancel pairing. **CANCELED** will appear on the display.
- Some older Bluetooth devices require the input of a passkey when pairing. If this is the case, enter 0000.

Searching for Bluetooth devices

Using this unit, you can select one Bluetooth device that has already been paired and only search for and connect with it. Press the **DEVICE SEL/PAIRING** button on the main unit or the **DEVICE SEL** button on the remote control to show the name of the currently connected Bluetooth device (or Bluetooth device that is ready to be connected) on the display. It will blink for two seconds.





During this time, press the **DEVICE SEL/PAIRING** button on the main unit or the **DEVICE SEL** on the remote control again to change the Bluetooth device.

NOTE

When an already paired Bluetooth device seeks to connect with this unit, this unit will accept and connect with that Bluetooth device if this unit is not already connected to another Bluetooth device.

Controlling Bluetooth devices

If the connected Bluetooth device supports AVRCP, you can control it using this unit or the included RC-CD200BT wireless remote control.

- | | |
|--|--------------------------|
| PLAY/PAUSE button: | Play and pause |
| STOP button: | Stop |
| Skip ( /  and  / ) buttons: | Select tracks and search |

CAUTION

These might not function properly depending on the connected Bluetooth device.

Playback from Bluetooth devices

After pairing with a Bluetooth device in advance, you can play back audio from that device using the following procedures.

1. Press the **PLAY MODE/PLAY AREA [SOURCE SEL]** button while pressing the **DISPLAY [SHIFT]** button on the main unit or press the **SOURCE SEL** button on the remote control to set the current source to Bluetooth.
2. The unit searches for the selected Bluetooth device (shown on the display) and connects with it as soon as it finds it. When connected, **CONNECT** appears on the display for two seconds and the  icon appears.

After doing this, you will be able to control the Bluetooth device from this unit or the included RC-CD200BT wireless remote control, as well as output the playback audio from the Bluetooth device from this unit.

5 – Bluetooth device playback

Bluetooth information display

The  icon on the display shows the connection status of the Bluetooth device.

 icon status	Connection status
Blinking	Not connected (searching for Bluetooth device)
Not blinking	Connected with Bluetooth device

When the current source is Bluetooth, you can select the information shown on the display (name of connected device or connected (A2DP) codec).

Press the **DISPLAY [SHIFT]** button on the main unit or the **DISPLAY** button on the remote control to show the type of information currently selected in the main display area for two seconds.

During this time, press the **DISPLAY [SHIFT]** button on the main unit or the **DISPLAY** button on the remote control again to change the type of information shown.

The A2DP codec used for connection is displayed as one of the following.



Not connected (searching)



SBC codec used



AAC codec used



Qualcomm®aptX™ audio codec used

NOTE

- After pressing the **DISPLAY [SHIFT]** button on the main unit or the **DISPLAY** button on the remote control, the currently selected type of display information is shown for two seconds as follows.

Connected device name: DEV NAME

Connected A2DP codec: CODEC

- If the name of the connected device contains characters that cannot be shown, _ will appear in place of those characters.
- Depending on the connected Bluetooth device, the device's name might not be shown. " _____ " appears instead.

- If pairing has not been conducted (or pairing information has been deleted), NO PAIR will appear in place of the connected device name and the connected A2DP codec.

Deleting pairing information

Use the following procedures to delete all pairing information from this unit.

If you delete pairing information, connection with Bluetooth devices will not occur.

- Press the **POWER** switch to turn the unit off.
- While pressing and holding the **PAIRING** button on the unit, press the **POWER** switch again to turn the unit on.

When **ERASING** appears on the display, release the **PAIRING** button on the unit.



After the pairing information is deleted, the unit begins operation as normal.

6 – Message Lists

Operation messages

Depending on the operation of the unit, the following messages will appear in the main display area.

Message	Meaning	Response
-AUX-	AUX IN is selected as the current source.	
CANCELED	An operation has been canceled.	
-CLEAR-	All programs have been cleared.	
CLOSE	The disc tray is closing.	
CONNECT	The unit is connected with a Bluetooth device.	
ERASING	All pairing data is being erased.	
NO DISC	There is no disc or the disc cannot be verified.	
NO FILES	The data CD has no files that can be played back.	Load a disc that contains playable files.
NO NAME	There is no artist data or no file data that can be displayed.	
NO PAIR	The unit is not paired with any Bluetooth device.	
NO TITLE	There is no title data that can be displayed.	
OPEN	The disc tray is open.	
PAIRED	Pairing has succeeded.	
PAIRING (Blinking)	Pairing is being conducted.	
TOC READ	A file is being processed. Do not remove the media.	

Warning messages

If an operation cannot be completed, one of the following messages will appear for about two seconds and then disappear.

Message	Meaning	Response
NO PGM	No program has been created.	Add tracks to the program.
PGM FULL	No more tracks can be added to the program.	A program can contain a maximum of 99 tracks. Clear tracks from the program and try again.

Error messages

If one of the following error messages is shown, please refer to the Response column and try to resolve it. If you are still unable to correct the problem, please contact the nearest retailer or TASCAM customer support service.

Message	Meaning	Response
BT ERR (Blinking)	Communication with the Bluetooth receiver is not possible.	Contact the nearest retailer or TASCAM customer support service.
COMM ERR (Blinking)	Cannot communicate with the CD drive.	Contact the nearest retailer or TASCAM customer support service.
COMM ERR	An error occurred during communication with the CD drive.	Contact the nearest retailer or TASCAM customer support service.
DEC ERR	The file type is not supported or otherwise could not be played.	Change the data CD.
DISC ERR	The TOC or file system could not be read, or focus adjustment was not possible.	Clean or change the disc.
DRV ERR	The CD drive hardware is broken.	Contact the nearest retailer or TASCAM customer support service.
READ ERR	The track cannot be accessed.	Clean or change the disc.

7 – Troubleshooting

If you have problems with your system, look through this chart and see if you can solve the problem yourself before calling the nearest retailer or TASCAM customer support service.

■ No power

- ➔ Is the unit's power plug completely inserted into a working power outlet?

■ Remote control doesn't work.

- ➔ Check to see if the batteries are properly installed in the remote control.
- ➔ If the batteries are dead, change the batteries.

■ No sound

- ➔ Check the connection to the monitor system again.
- ➔ Check the volume and settings of the amplifier.

■ There is unwanted noise.

- ➔ Are the connecting cables all properly connected and functioning?

■ A CD cannot be played back.

- ➔ If you are using a data CD with MP3 files, confirm that the file bit-rates are compatible with this unit.
- ➔ Is the disc scratched or dirty?

■ I cannot play back all the files on a data CD.

- ➔ Make sure the unit is not in folder playback mode.

■ I cannot use program playback.

- ➔ Make sure the playback area is not set to **ALL PLAY**. To use program playback with data CDs, the playback area must be set to **FOLDER**.

■ The audio skips or there is noise.

- ➔ Is there a wireless LAN, another Bluetooth device, a microwave oven or a similar device nearby? Use this unit as far as possible from such devices.
- ➔ Reduce the distance between the Bluetooth device and this unit when using them together. Try changing the positions of the Bluetooth device and this unit.
- ➔ If you are using any applications on a smart phone other than one for audio playback, the sound might skip. If this occurs, stop the operation of applications other than the one for audio playback.

■ The unit cannot connect to the device or transmission between them is disrupted.

- ➔ Confirm that the Bluetooth device's power is on and that its Bluetooth function is also on.
- ➔ Is the Bluetooth device too far from the unit? Is a wall or other obstacle interfering with transmission? If the Bluetooth device is behind this unit, the unit itself could be blocking transmission. Change the positions of the Bluetooth device and this unit.
- ➔ Try turning this unit off and then on again.
- ➔ Delete the "CD-200BT" pairing from the Bluetooth device and then follow the procedures in "Pairing" to pair with it again.

■ Cannot pair with a device.

- ➔ Confirm that the Bluetooth device you want to pair with supports A2DP and AVRCP.
- ➔ Confirm that the Bluetooth device you want to connect with is able to communicate. For details, refer to the operation manual of that device.
- ➔ Turn this unit and the Bluetooth device off once and on again, and then try pairing them.
- ➔ Turn off any other Bluetooth devices other than the one that you are trying to pair with.
- ➔ Delete the "CD-200BT" pairing from the Bluetooth device and then try pairing again.

8 – Specifications

Ratings

Supported disc types

CD, CD-R and CD-RW discs
(including 12cm, 8cm and multisession discs and discs with CD text)

Playback file formats

CD-DA: 44.1kHz, 16-bit stereo
MP2: 32/44.1/48kHz, 32–384kbps (data CDs)
MP3: 32/44.1/48kHz, 32–320kbps, VBR (data CDs)
WAV: 8/16/32/11.025/22.05/44.1/12/24/48kHz, 16-bit
(data CDs)

Input and output ratings

Analog audio input

AUX IN jack

Connector: 3.5mm stereo mini jack
Reference input level: –20 dBV
Maximum input level: –4 dBV
Input impedance: 22 k Ω

Analog audio output ratings

ANALOG OUTPUT (UNBALANCED)

Connector: RCA pin jack
Output Impedance: 200 Ω
Reference Output Level: –10 dBV (0.32 Vrms)
Maximum Output Level: +6 dBV (2.0 Vrms)

PHONES output

Connector: 6.3 mm (1/4") Stereo Phone Jack
Maximum Output Level: 20 mW + 20 mW
(THD+N: 0.1%, 32 Ω)

Digital audio output ratings

DIGITAL OUTPUT (COAXIAL)

Connector: RCA Pin Jack
Compatible Signal Format: IEC-60958-3 (S/PDIF)

DIGITAL OUTPUT (OPTICAL)

Connector: TOS (JEITA RC-5720C)
Compatible Signal Format: IEC-60958-3 (S/PDIF)

Audio performance

Frequency Response

20 Hz - 20 kHz \pm 1.0 dB (during playback, JEITA)

Signal-to-Noise Ratio (S/N)

More than 90 dB (during playback, JEITA)

Total Harmonic Distortion

Less than 0.01% (during playback, JEITA)

Dynamic Range

More than 90 dB (during playback, JEITA)

Channel Separation

More than 90 dB (during playback, JEITA)

Backup memory

The following settings are backed up even when the unit power is turned off.

- Time and title display settings
- Playback mode
- Program (when CD loaded)
- Current folder (when data CD loaded)
- Current source
- Repeat playback function setting (ON/OFF)
- Pitch control ON/OFF (CD)
- Pitch control value (CD)
- Bluetooth pairing information (up to 8 devices)

Bluetooth

Version:	3.0
Output class:	Class 2
(approximate transmission distance:	10m*)
Supported profiles:	A2DP, AVRCP
Supported A2DP codecs:	SBC, AAC,
Qualcomm [®] aptX [™] audio	
Supported A2DP content protection:	SCMS-T

*The transmission distance is approximate. The transmission distance could vary depending on the surrounding environment and electromagnetic waves.

8 – Specifications

General

Power Requirement

AC 120 V, 60 Hz (U.S.A./Canada)
AC 230 V, 50 Hz (U.K./Europe)
AC 240 V, 50 Hz (Australia)

Power Consumption

8 W (U.S.A./Canada/U.K./Europe)
9 W (Australia)

Dimensions (W x H x D)

481 x 94.5 x 298 (mm) / 18.94 x 3.72 x 11.73 (in)

Weight

4.5 kg (9.92 lb)

Operating Temperature

5 to 35°C

Inclination of installation

5° or less

Dimensions

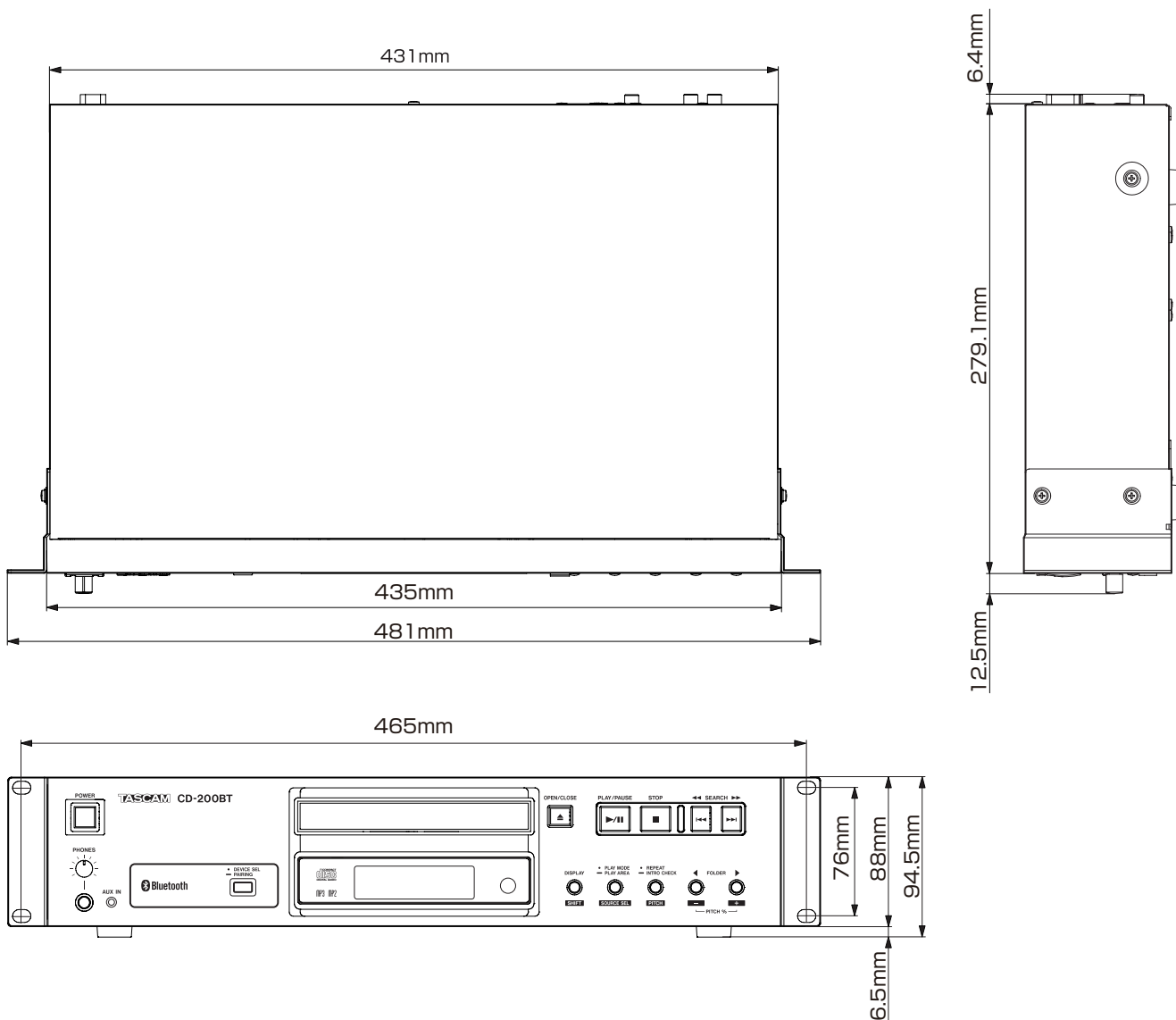

- Illustrations and other depictions may differ in part from the actual product.
- Specifications and external appearance may be changed without notification to improve the product.

CD-200BT

TEAC CORPORATION

1-47 Ochiai, Tama-shi, Tokyo 206-8530 Japan

<https://tascam.jp/jp/>

TEAC AMERICA, INC.

10410 Pioneer Blvd., Unit #3, Santa Fe Springs, CA 90670, U.S.A

<https://tascam.com/us/>

TEAC UK Ltd.

Luminous House, 300 South Row, Milton Keynes, Buckinghamshire, MK9 2FR, UK

<https://www.tascam.eu/en/>

TEAC EUROPE GmbH

Bahnstrasse 12, 65205 Wiesbaden-Erbenheim, Germany

<https://www.tascam.eu/de/>

TEAC SALES & TRADING(SHENZHEN) CO., LTD

Room 817, Xinian Center A, Tairan Nine Road West, Shennan Road, Futian District, Shenzhen, Guangdong Province 518040, China

<https://tascam.cn/cn/>