

D01175220A

TASCAM

DP-006

Digital Multitrack Recorder

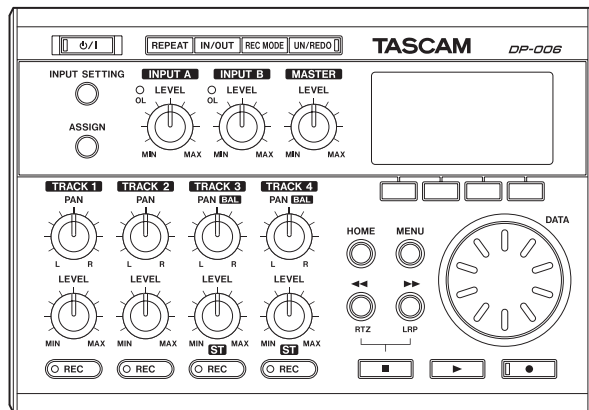

OWNER'S MANUAL

IMPORTANT SAFETY PRECAUTIONS

■ For U.S.A

TO THE USER

This equipment has been tested and found to comply with the limits for a Class B digital device, pursuant to Part 15 of the FCC Rules. These limits are designed to provide reasonable protection against harmful interference in a residential installation. This equipment generates, uses, and can radiate radio frequency energy and, if not installed and used in accordance with the instruction manual, may cause harmful interference to radio communications. However, there is no guarantee that interference will not occur in a particular installation. If this equipment does cause harmful interference to radio or television reception, which can be determined by turning the equipment off and on, the user is encouraged to try to correct the interference by one or more of the following measures.

- a) Reorient or relocate the receiving antenna.
- b) Increase the separation between the equipment and receiver.
- c) Connect the equipment into an outlet on a circuit different from that to which the receiver is connected.
- d) Consult the dealer or an experienced radio/TV technician for help.

CAUTION

Changes or modifications to this equipment not expressly approved by TEAC CORPORATION for compliance could void the user's authority to operate this equipment.

■ For Canada

THIS CLASS B DIGITAL APPARATUS COMPLIES WITH CANADIAN ICES-003.
CET APPAREIL NUMÉRIQUE DE LA CLASSE B EST CONFORME À LA NORME
NMB-003 DU CANADA.

Declaration of Conformity

Model Number : DP-006
Trade Name : TASCAM
Responsible party : TEAC AMERICA, INC.
Address : 7733 Telegraph Road, Montebello, California, U.S.A.
Telephone number : 1-323-726-0303

This device complies with Part 15 of the FCC Rules. Operation is subject to the following two conditions: (1) this device may not cause harmful interference, and (2) this device must accept any interference received, including interference that may cause undesired operation.

This appliance has a serial number located on the rear panel. Please record the model number and serial number and retain them for your records.

Model number _____

Serial number _____

IMPORTANT SAFETY INSTRUCTIONS

- 1 Read these instructions.
- 2 Keep these instructions.
- 3 Heed all warnings.
- 4 Follow all instructions.
- 5 Do not use this apparatus near water.
- 6 Clean only with dry cloth.
- 7 Do not block any ventilation openings. Install in accordance with the manufacturer's instructions.
- 8 Do not install near any heat sources such as radiators, heat registers, stoves, or other apparatus (including amplifiers) that produce heat.
- 9 Do not defeat the safety purpose of the polarized or grounding-type plug. A polarized plug has two blades with one wider than the other. A grounding type plug has two blades and a third grounding prong. The wide blade or the third prong are provided for your safety. If the provided plug does not fit into your outlet, consult an electrician for replacement of the obsolete outlet.
- 10 Protect the power cord from being walked on or pinched particularly at plugs, convenience receptacles, and the point where they exit from the apparatus.
- 11 Only use attachments/accessories specified by the manufacturer.
- 12 Use only with the cart, stand, tripod, bracket, or table specified by the manufacturer, or sold with the apparatus. When a cart is used, use caution when moving the cart/apparatus combination to avoid injury from tip-over.



- 13 Unplug this apparatus during lightning storms or when unused for long periods of time.
- 14 Refer all servicing to qualified service personnel. Servicing is required when the apparatus has been damaged in any way, such as power-supply

cord or plug is damaged, liquid has been spilled or objects have fallen into the apparatus, the apparatus has been exposed to rain or moisture, does not operate normally, or has been dropped.

- The apparatus draws nominal non-operating power from the AC outlet with its POWER or STANDBY/ON switch not in the ON position.
- The mains plug is used as the disconnect device, the disconnect device shall remain readily operable.
- Caution should be taken when using earphones or headphones with the product because excessive sound pressure (volume) from earphones or headphones can cause hearing loss.
- If you are experiencing problems with this product, contact TEAC for a service referral. Do not use the product until it has been repaired.

CAUTION

- Do not expose this apparatus to drips or splashes.
- Do not place any objects filled with liquids, such as vases, on the apparatus.
- Do not install this apparatus in a confined space such as a book case or similar unit.
- The apparatus should be located close enough to the AC outlet so that you can easily grasp the power cord plug at any time.
- If the product uses batteries (including a battery pack or installed batteries), they should not be exposed to sunshine, fire or excessive heat.

WARNING

Products with Class I construction are equipped with a power supply cord that has a grounding plug. The cord of such a product must be plugged into an AC outlet that has a protective grounding connection.

Safety Information

■ For European Customers

Disposal of electrical and electronic equipment

- (a) All electrical and electronic equipment should be disposed of separately from the municipal waste stream via designated collection facilities appointed by the government or the local authorities.
- (b) By disposing of the electrical and electronic equipment correctly, you will help save valuable resources and prevent any potential negative effects on human health and the environment.
- (c) Improper disposal of waste equipment can have serious effects on the environment and human health as a result of the presence of hazardous substances in electrical and electronic equipment.
- (d) The crossed out wheeled dust bin symbol indicates that electrical and electronic equipment must be collected and disposed of separately from household waste.



- (e) The return and collection systems are available to the end users. For more detailed information about disposal of old electrical and electronic equipment, please contact your city office, waste disposal service or the shop where you purchased the equipment.

Disposal of batteries and/or accumulators

- (a) Waste batteries and/or accumulators should be disposed of separately from the municipal waste stream via designated collection facilities appointed by the government or the local authorities.
- (b) By disposing of waste batteries and/or accumulators correctly, you will help save valuable resources and prevent any potential negative effects on human health and the environment.
- (c) Improper disposal of waste batteries and/or accumulators can have serious effects on the environment and human health as a result of the presence of hazardous substances in batteries and/or accumulators.
- (d) The crossed out wheeled dust bin symbol indicates that batteries and/or accumulators must be collected and disposed of separately from household waste.

If the battery or accumulator contains more than the specified values of lead (Pb), mercury (Hg), and/or cadmium (Cd) defined in the Battery Directive (2006/66/EC), then the chemical symbols for lead (Pb), mercury (Hg) and/or cadmium (Cd) will be indicated beneath the crossed out wheeled dust bin symbol.



Pb, Hg, Cd

- (e) The return and collection systems are available to the end users. For more detailed information about disposal of waste batteries and/or accumulators, please contact your city office, waste disposal service or the shop where you purchased them.

CAUTIONS ABOUT BATTERIES

This product uses batteries. Misuse of batteries could cause a leak, rupture or other trouble. Always abide by the following precautions when using batteries.

- Never recharge non-rechargeable batteries. The batteries could rupture or leak, causing fire or injury.
- When installing batteries, pay attention to the polarity indications (plus/minus (⊕/⊖) orientation), and install them correctly in the battery compartment as indicated. Putting them in backward could make the batteries rupture or leak, causing fire, injury or stains around them.
- When you store or dispose batteries, isolate their terminals with insulation tape or something like that to prevent them from contacting other batteries or metallic objects.
- When throwing used batteries away, follow the disposal instructions indicated on the batteries and the local disposal laws.
- Do not use batteries other than those specified. Do not mix and use new and old batteries or different types of batteries together. The batteries could rupture or leak, causing fire, injury or stains around them.

- Do not carry or store batteries together with small metal objects. The batteries could short, causing leak, rupture or other trouble.
- Do not heat or disassemble batteries. Do not put them in fire or water. Batteries could rupture or leak, causing fire, injury or stains around them.
- If the battery fluid leaks, wipe away any fluid on the battery case before inserting new batteries. If the battery fluid gets in an eye, it could cause loss of eyesight. If fluid does enter an eye, wash it out thoroughly with clean water without rubbing the eye and then consult a doctor immediately. If the fluid gets on a person's body or clothing, it could cause skin injuries or burns. If this should happen, wash it off with clean water and then consult a doctor immediately.
- The unit power should be off when you install and replace batteries.
- Remove the batteries if you do not plan to use the unit for a long time. Batteries could rupture or leak, causing fire, injury or stains around them. If the battery fluid leaks, wipe away any fluid on the battery compartment before inserting new batteries.
- Do not disassemble a battery. The acid inside the battery could harm skin or clothing.

■ For China

产品有毒有害物质或元素的名称及含量

机种：DP-006		有毒有害物质或元素					
	品名	铅 (Pb)	汞 (Hg)	镉 (Cd)	六价铬 (Cr6+)	多溴联苯 (PBB)	多溴二苯醚 (PBDE)
1	CHASSIS 部份	○	○	○	○	○	○
2	PCB Assy 部份	×	○	○	○	○	○
3	线材部份	○	○	○	○	○	○
4	附属品部份	×	○	○	○	○	○
5	SEAL 部份	○	○	○	○	○	○
6	包装部份	○	○	○	○	○	○

○：表示该有毒有害物质在该部件所有均质材料中的含量均在 SJ/T11363-2006 标准规定的限量要求以下。

×：表示该有毒有害物质至少在该部件的某一均质材料中的含量超出 SJ/T11363-2006 标准规定的限量要求。
(针对现在代替技术困难的电子部品及合金中的铅)

Contents

1 – Introduction.....	9		
Features	9		
Included items	9		
Conventions used in this manual	10		
Trademarks.....	10		
About SD cards	11		
Precautions for use.....	11		
Precautions for installation.....	11		
Beware of condensation	11		
Cleaning the unit	11		
2–Quick Start Guides	12		
Playback and mixing	12		
Preparing.....	12		
Playing and mixing the demo song.....	13		
Recording and mastering	15		
Creating a new song	15		
Setting the internal mics as input sources.....	16		
Setting the internal mics as the recording sources for TRACK 3...	17		
Adjusting the input level and monitoring	18		
Using internal mics to record rhythm guitar to TRACK 3	19		
Listening to the recording.....	20		
Connecting an electric guitar.....	20		
Setting the guitar as an input source.....	21		
Recording lead guitar to TRACK 2.....	21		
Recording vocals on TRACK 1	23		
Creating a stereo master track.....	25		
Checking the stereo master track	27		
Transferring the stereo master track to a computer	28		
Shutting down.....	28		
3 – Names and functions of parts	29		
Top Panel.....	29		
Front panel.....	31		
		Rear panel.....	32
		Left side panel.....	32
		Right side panel.....	33
		Bottom panel.....	33
		Home Screen	34
		Menu structure	36
		Screen operations	37
4 – Preparations	39		
Preparing the power and SD card.....	39		
Inserting an SD card.....	39		
Removing an SD card	39		
SD card write-protection switches	39		
Preparing the power.....	40		
Start-up & shutdown	41		
Starting up the unit.....	41		
Shutting down	41		
Preparing SD cards for use	42		
Recorder modes	42		
Connecting with other equipment	43		
Rear panel connections.....	43		
Left side panel connections	43		
Right side panel connections.....	44		
Adjusting the contrast.....	44		
5 – Song Management	45		
Partitions and songs	45		
Selecting the active partition	45		
Editing names.....	46		
Loading a saved song	46		
Creating a new song.....	47		
Saving a song	47		
Viewing song information	48		
Copying songs	48		

Erasing songs.....	49	Repeat playback.....	65
Protecting songs.....	50	Setting IN and OUT points.....	65
6 – Basic Recording	51	Using repeat playback	66
Selecting the input source.....	51	Setting the time between repetitions (repeat interval).....	66
Monitoring the input signal	52	8 – Editing Tracks	67
Setting the monitoring mode.....	52	Overview of track editing.....	67
OL indicators and level meters.....	53	Editing points	67
Assigning inputs	54	Basic editing procedures	67
Setting the track type (Tracks 3 and 4 only).....	54	Track editing function setting items	68
Assigning inputs to stereo tracks (Tracks 3 and 4 only)	55	CLONE TRACK (track duplication).....	69
Assigning inputs to mono tracks.....	56	CLEAN OUT (track erase).....	70
Making the first recording	56	SILENCE (part erase).....	70
Multitrack recording.....	57	CUT (remove part)	71
Setting the recording tracks.....	57	OPEN (insert silence).....	71
Setting TRACK PAN/BAL and LEVEL values.....	57	9 – Mixdown and mastering.....	72
Input selection and assignment	57	Mixdown.....	72
Setting input levels	58	Level and balance	72
Recording additional tracks.....	58	Stereo position (panning).....	72
Undoing operations (undo).....	58	Creating stereo master tracks.....	72
Undoing the last operation (single undo).....	58	Setting the starting and ending points	72
Undoing a previous operation (multi-undo)	59	Creating a stereo master track.....	72
Erasing the operation history	60	Checking stereo master tracks.....	74
7 – Recorder Functions	61	10 – Miscellaneous Functions	75
Punching in and out	61	Metronome	75
Bouncing tracks.....	61	Tuner	76
Using the bounce function	62	Automatic power saving function.....	77
Confirming the result	63	Restoring preferences to default values	77
Locate and search functions	64	Viewing information.....	78
Direct locate function	64	11 – SD Card Management	79
Returning to the song beginning (RTZ function) or		Overview of partitions.....	79
the point where recording was last started (LRP function)	64	Formatting SD cards.....	79
Search backward/forward.....	64		

Contents

Reformatting MTR partitions	81
Reformatting FAT partitions	82
Initializing SD cards	82
12 – Exchanging Data with a Computer	83
Supported operating systems	83
Connecting with a computer	84
Disconnecting	85
Song backup and restoration	86
Backing-up songs	86
Restoring songs	87
Track import and export	88
Importing to tracks	88
Exporting tracks	90
Exporting stereo master tracks	92
13 – Troubleshooting	93
14 – Message Lists	94
15 – Specifications	98
Media and file systems	98
Inputs and outputs	98
Analog audio input and output	98
Data input and output	98
Audio performance	98
Operating requirements	99
General	99
Backup memory	100
Dimensions	100
Block diagram	101
16 – Commonly-used Functions	102

1 – Introduction

Thank you for your purchase of the TASCAM DP-006 Digital Multitrack Recorder.

Before connecting and using the unit, please take time to read this manual thoroughly to ensure you understand how to properly set up and connect the unit, as well as the operation of its many useful and convenient functions. After you have finished reading this manual, please keep it in a safe place for future reference.

You can also download the Owner's Manual from the TASCAM web site (<http://tascam.com>).

Features

Using this unit with an SD card, you can record two tracks simultaneously and work with up to six tracks in a multitrack project. Moreover, using its mixer functions, you can mix down a multitrack to create a stereo master track.

This stereo master track can then be transferred to a computer connected by USB. In addition to copying individual and stereo master tracks from this unit to a computer, song files can also be backed up to a computer.

- Portable six-track multitrack recorder capable of two tracks of simultaneous recording and six tracks of simultaneous playback
- **TRACK 3** and **TRACK 4** can be set individually for use as either stereo or mono tracks
- CD-quality recording (16-bit, 44.1kHz)
- Built-in omnidirectional stereo condenser mic suppresses pickup of background noise (3 input gain level settings—Low, Mid, High)
- 2 mic/line inputs (**INPUT A/B**) with standard 6.3mm TS jacks
- Guitars and basses can be connected directly to the **INPUT A** jack (switchable mic/line input)
- Independent **LEVEL** and **PAN** knobs allow direct control
- Wheel allows rapid location to specific points (direct location function)
- Set and use IN and OUT points as you like for repeat playback and editing
- Separate stereo master track in addition to six independent tracks
- Bounce function allows recording of more than six tracks
- Punch in/out function allows parts to be re-recorded as necessary

- Track editing functions include duplicating and deleting recorded tracks, partial clearing and deletion and silence insertion
- Recording and editing operations can be undone and redone
- Chromatic tuner with meters provides visual feedback during tuning
- Metronome
- Transfer files to computers connected by USB 2.0
- Backup and restore songs
- Import and export stereo WAV files to stereo tracks
- Export stereo masters as stereo WAV files
- Operates on four AA batteries or a TASCAM PS-P520 AC adaptor (sold separately)
- 2GB SD card included
- Unit has built-in threads for tripod mounting

Included items

This product includes the following items.

Take care when opening the package not to damage the items. Keep the packing materials for transportation in the future.

Please contact TASCAM if any of these items are missing or have been damaged during transportation.

- Main unit..... 1
- SD Card (inside unit) 1
- AA alkaline batteries..... 4
- USB cable (80cm) 1
- Warranty card..... 1
- Owner's Manual (this manual) 1

1 – Introduction

Conventions used in this manual

In this manual, we use the following conventions:

- When we refer to buttons, connectors and other parts of this unit and other equipment, we use a bold font like this: **MENU** button.
- The ► button is indicated as the Play (►) button, the ■ button as the Stop (■) button and the ● button as the Record (●) button.
- Selectable items and messages shown on the display are indicated like this: MENU
- The four buttons beneath the LCD display are called function buttons and are referred to as **F1**, **F2**, **F3** and **F4** from left to right. Their functions are shown above them at the bottom of the display and after the button name in brackets in this manual.
Examples: **F2** [EXEC] button, **F4** [►] button
- SD memory cards are called “SD cards”.
- Words that appear on the computer display are shown in quotation marks like this: “DP-006”
- The currently selected MTR partition is called the “active partition”.
- Additional information is provided as necessary as tips, notes and cautions.

TIP

These are tips about how to use the unit.

NOTE

These provide additional explanations and describe special cases.

CAUTION

Failure to follow these instructions could result in injury, damage to equipment or lost recording data, for example.

Trademarks

- TASCAM is a registered trademark of TEAC Corporation.
- Microsoft, Windows, Windows Vista, and Windows 7 are either registered trademarks or trademarks of Microsoft Corporation in the United States and/or other countries.
- Apple, Macintosh, iMac, Mac OS and Mac OS X are trademarks of Apple Inc.
- Other company names, product names and logos in this document are the trademarks or registered trademarks of their respective owners.

Any data, including, but not limited to information, described herein are intended only as illustrations of such data and/or information and not as the specifications for such data and/or information. TEAC Corporation disclaims any warranty that any use of such data and/or information shall be free from infringement of any third party's intellectual property rights or other proprietary rights, and further, assumes no liability of whatsoever nature in the event of any such infringement, or arising from or connected with or related to the use of such data and/or information.

This product is designed to help you record and reproduce sound works to which you own the copyright, or where you have obtained permission from the copyright holder or the rightful licensor. Unless you own the copyright, or have obtained the appropriate permission from the copyright holder or the rightful licensor, your unauthorized recording, reproduction or distribution thereof may result in severe criminal penalties under copyright laws and international copyright treaties. If you are uncertain about your rights, contact your legal advisor. Under no circumstances will TEAC Corporation be responsible for the consequences of any illegal copying performed using the recorder.

About SD cards

This unit uses SD cards for recording and playback.

SD cards that meet SD/SDHC standards and are at least 512 MB can be used with this unit.

A list of SD cards that have been confirmed for use with this unit can be found on the TASCAM website (<http://tascam.com/>). Please check this site or contact TASCAM customer support.

Precautions for use

SD cards are delicate media. In order to avoid damaging a card or the card slot, please take the following precautions when handling them.

- Do not leave them in extremely hot or cold places.
- Do not leave them in extremely humid places.
- Do not let them get wet.
- Do not put things on top of them or twist them.
- Do not hit them.

Precautions for installation

- The unit's nominal operating temperature is from 5° to 35° C (41°–95° F).
- Do not install in the following types of places. Doing so could degrade the sound quality or cause malfunctions.
 - Places with significant vibrations
 - Near windows or other places exposed to direct sunlight
 - Near heaters or other extremely hot places
 - Extremely cold places
 - Places with high humidity or bad ventilation
 - Dusty places
 - Places directly exposed to rain or other water
- Do not place this unit on top of a power amplifier or other device that generates heat.

Beware of condensation

If the unit is moved from a cold to a warm place, or used immediately after a cold room has been heated or otherwise exposed to a sudden temperature change, condensation could occur. Should this happen, leave the unit for one or two hours before turning the unit on.

Cleaning the unit

To clean the unit, wipe it gently with a soft dry cloth. Do not wipe with chemical cleaning cloths, paint thinner, ethyl alcohol or other chemical agents to clean the unit as they could damage the surface.

2-Quick Start Guides

Playback and mixing

First, we will play the demo song on the included SD card. When the unit is purchased new, the SD card with the demo song is shipped already installed, but we will start by explaining how to insert an SD card.

Preparing

1. Open the battery compartment cover on the bottom of the unit and insert the included SD card into the slot at the back.

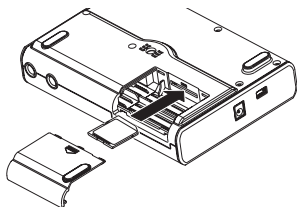

CAUTION

Do not insert the card backwards or apply unnecessary force. This could damage the slot or card.

2. Insert four AA batteries into the compartment, paying attention to their \oplus/\ominus orientations as shown below. This unit can use alkaline or NiMH batteries.

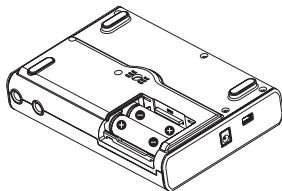

3. Close the battery compartment cover after installing the SD card and batteries.
4. Connect headphones to the Ω /LINE OUT jack on the left side of the unit.

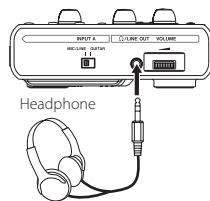

5. Press and hold the Power/Play button on the top panel until "TASCAM" appears on the display (or the Power/Play button indicator lights green). After the unit starts up, the Home Screen appears as shown below

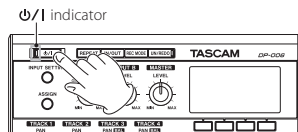

Startup Screen



Home Screen

CAUTION

- Do not remove or insert an SD card when the unit's power is ON. Make sure the unit power is OFF (in standby) before you remove or insert an SD card.
- If you remove or insert an SD card when the unit's power is ON, all data and settings that have been changed since the last shutdown or song saving operation will be lost. These data and settings cannot be recovered.
- When the unit power is ON, do not remove the batteries, disconnect the power cable or otherwise cut the power to the unit.
- The included alkaline batteries are for confirming operation of the unit and might only be usable for a short amount of time.
- The volume dial on the left side panel does not have any indications. Before turning the power ON or OFF (putting it into standby), minimize the volume on any connected external monitoring system (powered monitor speakers or an amplifier and speakers).
- Do not wear headphones when turning the power ON or OFF (putting it into standby) because noise at such times could harm your hearing.

TIPS

- This unit can also be powered by a TASCAM PS-P520 power adaptor (sold separately). (See "Using an AC adaptor (sold separately)" on page 40.)
- By connecting an external monitoring system (powered monitor speakers or an amplifier and speakers) to the Ω /LINE OUT jack on the left side of the unit, you can monitor recordings using speakers.

Playing and mixing the demo song

Before the unit is shipped, a demo song is stored on its SD card. We are now going to use basic playback and mixing features with this demo song.

1. Press the **HOME** button to open the Home Screen.

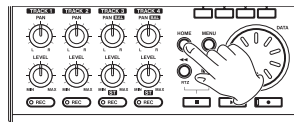

2. When the recorder is stopped, press the **MENU** button to open the MENU screen.

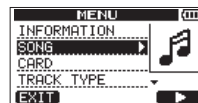
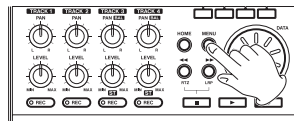

2 – Quick Start Guides

3. Use the **DATA** wheel to select (highlight) the **SONG** item, and press the **F4 [▶]** button to open the **SONG** menu.

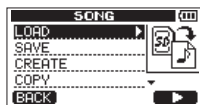
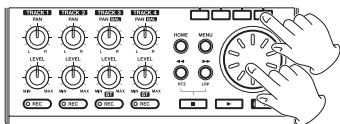

4. Use the **DATA** wheel to select (highlight) the **LOAD** item, and press the **F4 [▶]** button to open the **SONG LOAD** screen, which shows a list of songs.

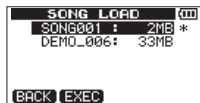

5. Use the **DATA** wheel to select (highlight) **DEMO_006** and press the **F2 [EXEC]** button.

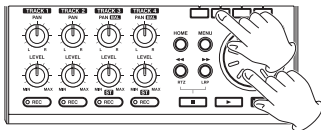

The demo song loads and the **SONG** menu reopens.

6. Press the **HOME** button to reopen the Home Screen.

7. Press the play (**▶**) button and turn up the **TRACK 1–4 LEVEL** knobs, the **MASTER LEVEL** knob and the **VOLUME** dial on the left side of the unit so you can hear the demo song.

The **MASTER LEVEL** knob adjusts the volume of tracks 1 to 4 at the same time. The standard position of the **MASTER LEVEL** knob is around 2 or 3 o'clock.

Use the **TRACK 1–4 LEVEL** knobs to adjust the balance between the tracks.

Use the **VOLUME** dial on the left side of the unit to adjust the final monitoring level.

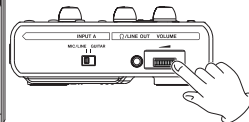
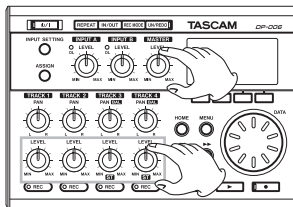

8. Use the **TRACK 1–2 PAN** knobs and **TRACK 3–4 PAN (BAL)** knobs to adjust the stereo positions of each track.

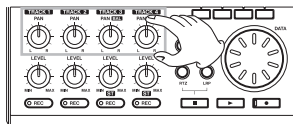

TIPS

- Press the **◀◀ [RTZ]** button while pressing and holding the Stop (**■**) button to return to the beginning (00h00m00s00f) of the song. (Return To Zero function)
- If you push the wrong button when using a menu, press the **HOME** button to return to the Home Screen.

Recording and mastering

Here, we will try multitrack recording.

In the following example, we will first explain how to use the built-in mics to record an acoustic guitar rhythm part on track 3 (by using the built-in stereo microphone pair to record the acoustic guitar to a stereo track, we can capture reverberations, including from the sound of the guitar body, that add a sense of depth).

Next, we will use an electric guitar to record a lead guitar part on track 2. Then, we will use the built-in mics to record singing on track 1. Finally, we will show how to mix these tracks down to stereo.

We assume that you have followed the instructions in the previous section "Playback and mixing" and already connected headphones to this unit, turned it on and loaded an SD card.

TIP

This example uses the built-in mic for recording vocals, but you could also connect an external mic to the INPUT A or INPUT B connector on the rear panel and record it.

Creating a new song

1. When the recorder is stopped, press the **MENU** button to open the MENU screen.

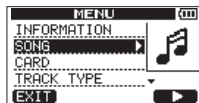
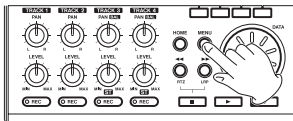

2. Use the **DATA** wheel to select (highlight) the **SONG** item, and press the **F4 [▶]** button to open the **SONG** screen.

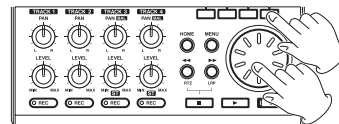

3. Use the **DATA** wheel to select (highlight) the **CREATE** item, and press the **F4 [▶]** button to open the **SONG CREATE** screen.

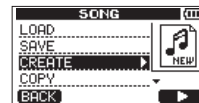

When a song is created, it is given the name (title) "SONG****" (where *** is a number).

4. Change the song name as necessary. (See "Editing names" on page 46.)

2 – Quick Start Guides

5. Press the **F2 [EXEC]** button to save the currently loaded song and create the new song.

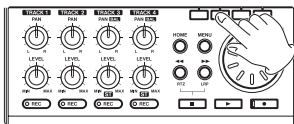

6. Press the **HOME** button to reopen the Home Screen.

Setting the internal mics as input sources

1. Press the **INPUT SETTING** button to open the **INPUT SETTING** screen. On this screen, you can set the input source for both **IN A (INPUT A)** and **IN B (INPUT B)**.

At first, the current input source for **IN A (INPUT A)** is selected (highlighted).

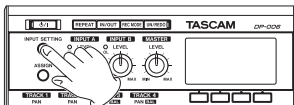

2. In order to use the built-in **MIC A** to record the guitar to stereo **TRACK 3**, use the **DATA** wheel to set the input source for **IN A (INPUT A)** to **INT MIC A-Low**, **INT MIC A-Mid** or **INT MIC A-High**. (See "Selecting the input source" on page 51.)

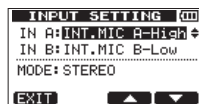
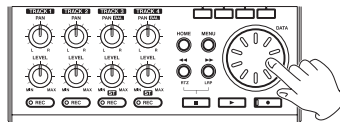

3. Press the **F4 [▼]** button to select (highlight) the current input source for **IN B (INPUT B)**.

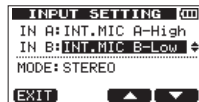
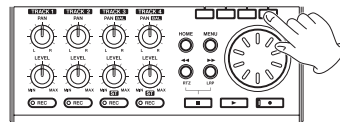

4. In order to use the built-in **MIC B** to record the guitar to stereo **TRACK 3**, use the **DATA** wheel to set the input source for **IN B (INPUT B)** to **INT MIC B-Low**, **INT MIC B-Mid** or **INT MIC B-High**. (See “Selecting the input source” on page 51.)

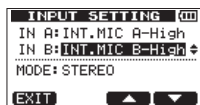
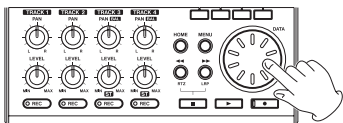

5. After completing the setting, press the **HOME** button to return to the Home Screen.

NOTE

- **INT.MIC X-Low**, **INT.MIC X-Mid** and **INT.MIC X-High** (X is A or B) settings change the sensitivity of the built-in mics. Set according to the loudness of the subject being recorded. If you are not sure which setting to use, choose **INT.MIC X-Low**. If the input level is still too low after adjusting it, return to **INPUT SETTING** screen and change the setting to **INT.MIC X-Mid**. If the input level is still not high enough, change the setting to **INT.MIC X-High**.
- Set the **MODE** item on the **INPUT SETTING** to monitor the input signals. (See “Setting the monitoring mode” on page 52.)

Setting the internal mics as the recording sources for TRACK 3

When the recorder is stopped, press the **ASSIGN** button to open the **INPUT ASSIGN** screen. By default the recording sources are assigned to the tracks as shown below.

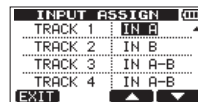

Recording track	Recording source	Default value
TRACK 1	INPUT A	IN A
TRACK 2	INPUT B	IN B
TRACK 3	INPUT A/B	IN A-B
TRACK 4	INPUT A/B	IN A-B

Since you set internal MIC A as the input source for **INPUT A** and internal MIC B as the input source for **INPUT B** on the **INPUT SETTING** screen in the previous “Setting the internal mics as input sources” section, signals from MIC A and MIC B will be recorded to **TRACK 3**.

So, in this example, you do not need to change the input source assignment settings to use the internal mics to record the rhythm guitar to **TRACK 3**.

2 – Quick Start Guides

Adjusting the input level and monitoring

1. Press the **HOME** button to reopen the Home Screen.

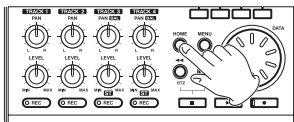

2. Press the **TRACK 3 REC** button to put the track into recording standby. The **REC** indicator blinks when in standby.

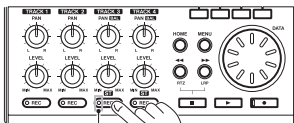

TRACK 3 REC indicator

3. Use the **INPUT A** and **B LEVEL** knobs to adjust the input levels of the internal mics.
Set the **LEVEL** knobs so that the loudest sounds do not cause the **INPUT A** and **B OL** indicators to light.

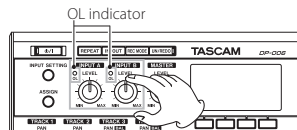

When you play the guitar, the **A** (**INPUT A**), **B** (**INPUT B**) and **C** (**TRACK 3**), **L** (left channel) and **R** (right channel) level meters on the display move.



Turn up the **MASTER LEVEL** knob and the **VOLUME** dial on the left side of the unit to hear the guitar sound through the headphones.

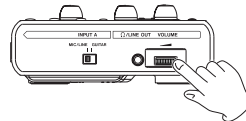
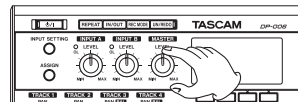

NOTE

- If an **OL** indicator continues to light even when the **LEVEL** knob is turned down, the mic signal itself is too loud. In this case, if the input source setting is **INT.MIC X-High**, change it to **INT.MIC X-Mid** or **INT.MIC X-Low** (X is A or B). If the **OL** indicator continues to light even when set to **INT.MIC X-Low**, move the sound source away from the mic or lower the volume at the sound source.
- When an internal mic is an input source if the **REC** indicator is unlit for the track with that mic as its recording source, you will not be able to hear that input signal.

CAUTION

Always monitor through headphones when using a mic. If you monitor through speakers, feedback could occur.

Using internal mics to record rhythm guitar to TRACK 3

1. Press the Play (▶) button while pressing and holding the Record (●) button to start recording and play the rhythm guitar part. The Record (●) indicator lights, and the **TRACK 3 REC** indicator stops blinking and stays lit.

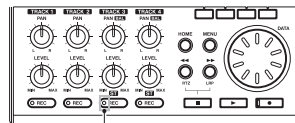

TRACK 3 REC indicator

2. When you are done playing, press the Stop (■) button to stop recording.
3. Press the **TRACK 3 REC** button to end recording standby. The **REC** indicator becomes unlit.

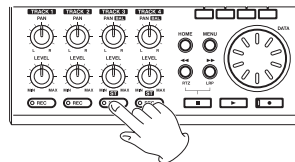

2 – Quick Start Guides

Listening to the recording

1. To go to the beginning of the song (00h00m00s00f) using the Return To Zero (RTZ) function, press the ◀ [RTZ] button while pressing and holding the Stop (■) button.
2. Press the Play (▶) button to play the recorded **TRACK 3**.
3. Use the **TRACK 3 LEVEL** knob and **MASTER LEVEL** knob to adjust the monitoring level.

Use the **VOLUME** dial on the left side of the unit to adjust the final monitoring volume.

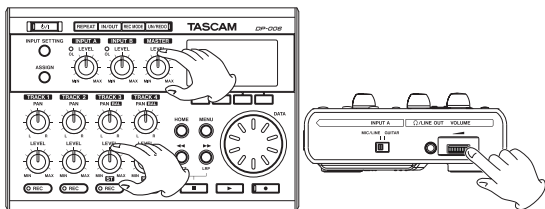

TIP

Use the **TRACK 3 PAN (BAL)** knob to set the stereo position of the track signal.

4. When you are done listening to the recording, press the Stop (■) button to stop playback.

Connecting an electric guitar

1. Connect an electric guitar to the **INPUT A** connector on the rear panel.

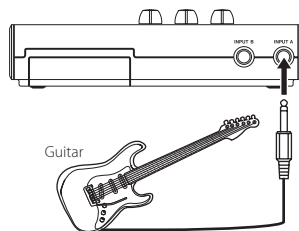

2. Set the **MIC/LINE-GUITAR** switch on the left side of the unit to **GUITAR**.

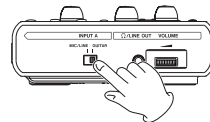

TIP

When connecting an electric-acoustic guitar with a built-in preamp or an active electric guitar, as well as when connecting an electric guitar with effect boxes between it and this unit, set the **MIC/LINE-GUITAR** switch to **MIC/LINE**.

Setting the guitar as an input source

1. Press the **INPUT SETTING** button to open the **INPUT SETTING** screen.

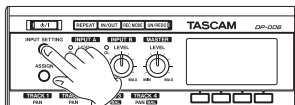

2. In order to use the guitar/line input to record guitar to **TRACK 2**, use the **DATA** wheel to set the input source for **IN A (INPUT A)** to **GUITAR/LINE**, **GUITAR/LINE M** or **GUITAR/LINE H**.

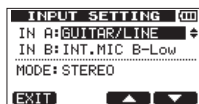
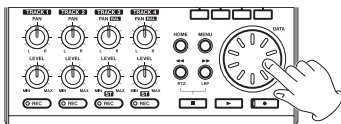

3. Press the **HOME** button to reopen the Home Screen.

NOTE

GUITAR/LINE, **GUITAR/LINE M** and **GUITAR/LINE H** settings change the input gain. Set according to the level of the input. If you are not sure which setting to use, choose **GUITAR/LINE**. If the input level is still too low after adjusting it, return to **INPUT SETTING** screen and change the setting to **GUITAR/LINE M**. If the input level is still not high enough, change the setting to **GUITAR/LINE H**.

Recording lead guitar to TRACK 2

Now, you will record lead guitar on **TRACK 2** while listening to the rhythm guitar on **TRACK 3**.

Follow these steps to change the recording source for **TRACK 2**.

1. When the recorder is stopped, press the **ASSIGN** button to open the **INPUT ASSIGN** screen.

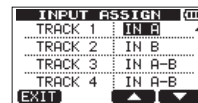
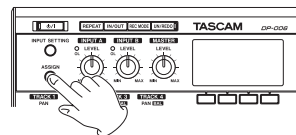

2 – Quick Start Guides

- Use the **F4** [▼] button to select (highlight) current recording source for **TRACK 2** (default value: IN B).

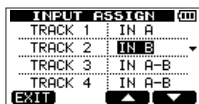

- Use the **DATA** wheel to select **IN A**.

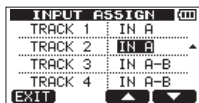

- Press the **HOME** button to reopen the Home Screen.



- Press the **TRACK 2 REC** button to put the track into recording standby. The **REC** indicator blinks when in standby. When you play the guitar, the input level is shown by the **(A)** (INPUT A), **(B)** (TRACK 2) and **(L)** (left channel) level meters.

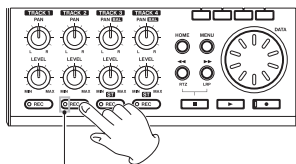

TRACK 2 REC indicator

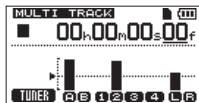

- After returning to the beginning of the song (00h00m00s00f), press the Play (▶) button to play back the recorded **TRACK 3**. Play the lead guitar part along with the already recorded rhythm guitar. You can hear the sound of the guitar being input along with the **TRACK 3** playback sound through the headphones.

7. As necessary, use the **INPUT A LEVEL**, **TRACK 3 LEVEL** and **PAN [BAL]** knobs and **MASTER LEVEL** knob, along with the **VOLUME** dial on the left side of the unit to adjust the monitoring levels and balance.

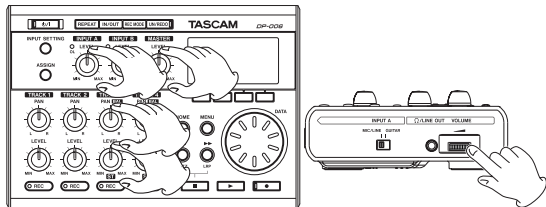

8. When you are done listening to the recording, press the Stop (■) button to stop playback.
9. After returning to the start of the song (00h00m00s00f), press the Play (▶) button while pressing and holding the Record (●) button to start recording, and play the lead guitar part. The Record (●) indicator lights and the **TRACK 2 REC** indicator stops blinking and stays lit.
10. When you are done playing, press the Stop (■) button to stop recording.
11. Press the **TRACK 2 REC** button to end recording standby. The **REC** indicator becomes unlit.

NOTE

If the OL indicator continues to light even when the LEVEL knob is turned down, the guitar signal itself is too loud. In this case, if the input setting is GUITAR/LINE H, change it to GUITAR/LINE M or GUITAR/LINE. If the input setting is GUITAR/LINE M, change it to GUITAR/LINE. If the OL indicator continues to light even when set to GUITAR/LINE, lower the guitar's output volume.

Recording vocals on TRACK 1

1. Press the **HOME** button to reopen the Home Screen.



2. Press the **TRACK 1 REC** button to put the track into recording standby. The **REC** indicator blinks when in standby.

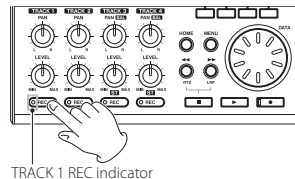

TRACK 1 REC indicator

3. Use the **INPUT A LEVEL** knob to adjust the input level of the internal mic. Set the **LEVEL** knob so that the loudest sounds do not cause the **INPUT A OL** indicator to light.

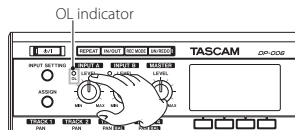

2 – Quick Start Guides

When you sing into internal MIC A, the input level is shown by the **INPUT A**, **TRACK 1** and **L** (left channel) level meters on the display.

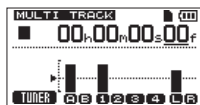

Turn up the **MASTER LEVEL** knob and the **VOLUME** dial on the left side of the unit to hear the mic signal through the headphones.

NOTE

- If the **OL** indicator continues to light even when the **LEVEL** knob is turned down, the mic signal itself is too loud. In this case, if the input source setting is **INT.MIC A-High**, change it to **INT.MIC A-Mid** or **INT.MIC A-Low**. If the input setting is **INT.MIC A-Mid**, change it to **INT.MIC A-Low**. If the **OL** indicator continues to light even when set to **INT.MIC A-Low**, move the sound source away from the mic or lower the volume at the sound source.
- When the input source is a built-in mic, the signal from the built-in mic cannot be monitored if the **REC** indicator of the track that it is assigned to is not lit.

CAUTION

When using a microphone, always use headphones to monitor. Using speakers to monitor could result in feedback.

4. After returning to the start of the song (00h00m00s00f), press the Play (▶) button while pressing and holding the Record (●) button to start recording, and sing along with the already recorded lead and rhythm guitar parts.
You can hear singing and the recorded guitars playing back on **TRACK 2** and **TRACK 3**.

5. As necessary, use the **TRACK 2** and **3 LEVEL** and **PAN (PAN [BAL])** knobs, the **MASTER LEVEL** knob and the **VOLUME** dial on the left side of the unit to adjust the monitoring levels and balance.

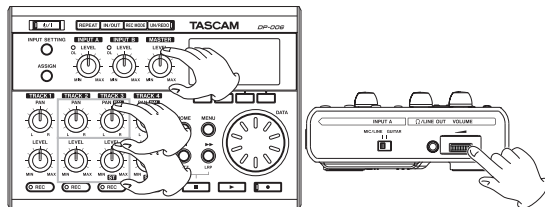

6. When you are done listening to the recording, press the Stop (■) button to stop playback.
7. After returning to the start of the song (00h00m00s00f), press the Play (▶) button while pressing and holding the Record (●) button to start recording, and sing the vocal part.
The Record (●) indicator lights red and the **TRACK 1 REC** indicator stops blinking and stays lit.
8. When you are done singing, press the Stop (■) button to stop recording.
9. Press the **TRACK 1 REC** button to turn off the **REC** indicator (ending recording standby).

Creating a stereo master track

After you finish recording, the next step is to mix down the tracks and make a stereo master track.

1. Use the **TRACK 1–3 LEVEL** knobs to adjust the levels of the tracks and the balance between them. Use the **MASTER LEVEL** knob to adjust the overall level.

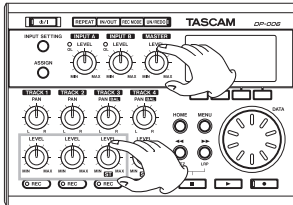

2. Use the **TRACK 1–2 PAN** knobs and **TRACK 3 PAN (BAL)** knob to adjust the stereo positioning of the tracks. Watch the **L** (left channel) and **R** (right channel) meters on the display as you make these adjustments.

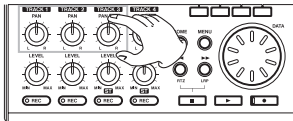

3. Press the **IN/OUT** button to open the **I/O SETTING** screen.

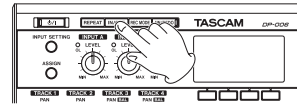

4. Set the IN point.

The time between the IN and OUT points will be included in the stereo master track.

Press the Play (▶) button to start playback, and press the **F3 [IN]** button at the point where you want to start the stereo master track.

A **SET IN!** pop-up message appears.

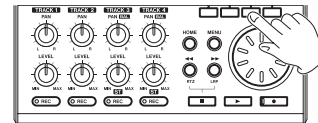

The point when you pressed the **F3 [IN]** button will be set as the IN point and used as the starting point for making the stereo master track.

2 – Quick Start Guides

- Set the OUT point.
Press the **F4 [OUT]** button at the point where you want to end the stereo master track.
A **SET OUT!** pop-up message appears.

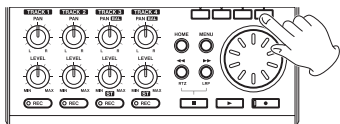

The point when you pressed the **F4 [OUT]** button will be set as the OUT point and used as the ending point for making the stereo master track.

TIP

*You can also use the **F3 [IN]** and **F4 [OUT]** buttons to set the IN and OUT points when playback is stopped.*

- When you have completed setting the IN and OUT points, press the Stop (■) button to stop playback of the song.

- When the recorder is stopped, press the **REC MODE** button to open the **RECORDER MODE** screen.

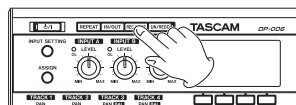

- Use the **DATA** wheel to select (highlight) **MASTER REC**.

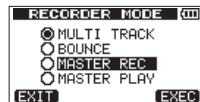
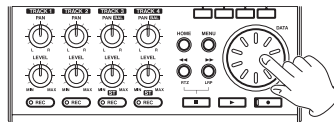

9. Press the **F4 [EXEC]** button.
After a **Master Rec!** pop-up message appears, the unit enters master recording mode and the Home Screen reopens.

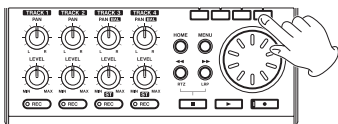

NOTE

When in master recording mode, **MASTER REC** appears highlighted at the top left of the Home Screen.

10. Press the Play (▶) button while pressing and holding the Record (●) button to start recording the stereo master track from the IN point. Recording automatically stops when the OUT point is reached.

NOTE

- Set the **IN** and **OUT** points at least four seconds apart. If they are less than four seconds apart, a **Trk Too Short** pop-up message will appear and you will not be able to change the unit to master recording mode.
- You can use the **LEVEL** knobs to adjust the track and overall levels as you record the master track.

Checking the stereo master track

You can play back the stereo master track that you created to check it.

1. When the recorder is stopped, press the **REC MODE** button to open the **RECORDER MODE** screen.

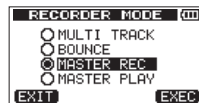
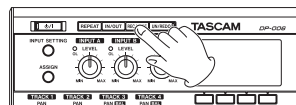

2. Use the **DATA** wheel to select (highlight) **MASTER PLAY**.

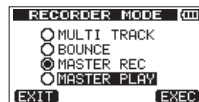
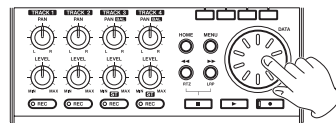

2 – Quick Start Guides

- Press the **F4 [EXEC]** button.
After a **Master Play!** pop-up message appears, the unit enters master play mode and the Home Screen reopens.

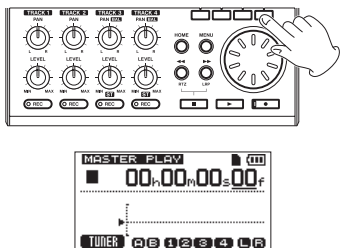

NOTE

- When in master play mode, **MASTER PLAY** appears highlighted at the top left of the Home Screen.
 - If you have not made a stereo master track, you will not be able to put the unit into **MASTER PLAY** mode.
- In this state, you can press the Play (▶) button to play back the stereo master track.

Transferring the stereo master track to a computer

After creating a stereo master track following the procedures in “Creating stereo master tracks” on page 72, you can transfer it to a computer connected using the included USB cable. For instructions about how to transfer the stereo master track to a computer, see “12 – Exchanging Data with a Computer” on page 83.

Shutting down

When you are done using the unit, shut it down.

- Press the **HOME** button to show the Home Screen.
- Press and hold the **POWER** button until **POCKETSTUDIO** appears on the display.

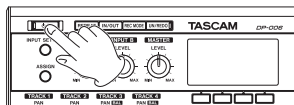

The power turns OFF automatically after the unit completes its shutdown process, including saving various information from your session.

Always follow the above procedures to shut down the unit properly.

CAUTION

Do not remove the batteries or disconnect the power cord, for example, to turn the power OFF. If you do so, the unit cannot shut down properly and all recording data and settings that had been made since the last shutdown or song saving operation will be lost. Lost data and settings cannot be restored.

3 – Names and functions of parts

Top Panel

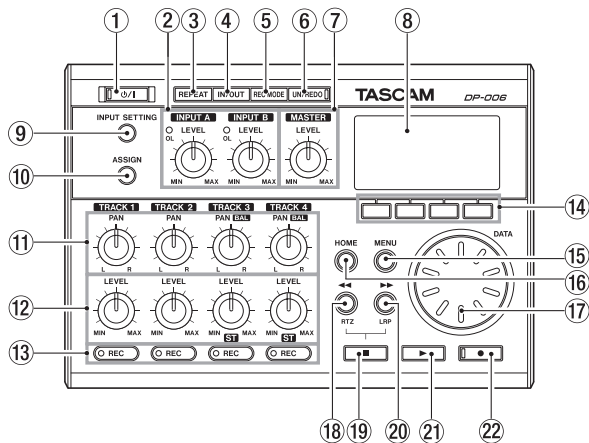

① **⏻/I button / indicator**

Press and hold this button to turn the unit ON and OFF. (See “Start-up & shutdown” on page 41.)

The indicator lights when the power is on.

② **INPUT A/B LEVEL knobs and OL indicators**

Use the **LEVEL** knobs to adjust the input levels for **INPUT A/B**. (See “Making the first recording” on page 56.)

If an input source level is too high its **OL** (overload) indicator lights. If a **LEVEL** knob is set too high (higher than 2–3 o'clock), the **OL** indicator could light even if the volume of the input source signal is suitable.

③ **REPEAT button**

Turns the repeat playback mode ON and OFF. (See “Repeat playback” on page 65.)

④ **IN/OUT button**

Press this button to open the **I/O SETTING** screen, and to set IN (starting) and OUT (ending) points for repeat playback and track editing. (See “Setting IN and OUT points” on page 65.)

The IN and OUT points are also used as the starting and ending points when creating stereo master tracks.

⑤ **REC MODE button**

Press this button to open the **RECORDER MODE** screen where you can set the recorder mode. (See “Recorder modes” on page 42.)

⑥ **UN/REDO button / indicator**

Press this button to undo the previous action or to redo the last undone action. (See “Undoing operations (undo)” on page 58.)

Press this button while pressing and holding the Stop (■) button to open the **HISTORY** screen. Using this screen, you can undo multiple operations at once.

This indicator lights when one or more operations that have been undone can still be redone.

⑦ **MASTER LEVEL knob**

This adjusts the stereo signal level output from the **Ω/LINE OUT** jack

This knob also adjusts the recording level when bouncing tracks, mixing down and mastering.

⑧ **Display**

This shows various information.

⑨ **INPUT SETTING button**

Press this button to open the **INPUT SETTING** screen where you can set input sources. (See “Selecting the input source” on page 51.)

3 – Names and functions of parts

10 **ASSIGN button**

Use this to assign (set) the TRACK inputs (**INPUT A/B**). Press this button to open the **INPUT ASSIGN** screen on the display. Signals from assigned inputs become the recording sources. (See “Assigning inputs” on page 54.)

11 **PAN knobs (TRACK 1–TRACK 4) TRACK 1 and TRACK 2**

Use to adjust the stereo position of the track playback signal. (See “Stereo position (panning)” on page 72.)

TRACK 3 and TRACK 4

If the track is stereo, use to adjust the left-right balance.

If the track is mono, use to adjust the stereo position of the track playback signal in the same way as for **TRACK 1** and **TRACK 2**. (See “Stereo position (panning)” on page 72.)

12 **LEVEL knob (TRACK 1–TRACK 4)**

Use to adjust the level of the track. (See “Level and balance” on page 72.)

13 **REC buttons/indicators (TRACK 1–TRACK 4)**

Use to turn the track record function ON (arm for recording) and OFF. To monitor the input signals of the internal mics using headphones or an external monitoring system (powered monitor speakers or an amplifier and speakers), press the corresponding **TRACK REC** button. When a **REC** button is ON, its **REC** indicator blinks when the recorder is stopped, and lights when it is recording.

14 **Function buttons**

The functions of these buttons depend on the current screen. The functions currently assigned to these buttons are shown at the bottom of the display screen.

NOTE

*In this manual, the four function buttons are referred to as **F1**, **F2**, **F3** and **F4** in order from the left.*

15 **MENU button**

Press to open the **MENU** screen. (See “Menu structure” on page 36.)

16 **HOME button**

Press to open the the Home Screen. (See “Home Screen” on page 34.)

When the unit is stopped and the Home Screen is open, use this button to move the cursor between time counter divisions. (See “Direct locate function” on page 64.)

17 **DATA wheel**

Use this to select items and change values on the setting screens.. When the unit is stopped and the Home Screen is open, turn to change the record/playback position. (See “Direct locate function” on page 64.)

18 **◀◀ [RTZ] button**

Press when stopped or playing back to search backward. Press it again to change the speed from 10x to 50x, again for 100x and 1000x.

Press while pressing and holding the Stop (■) button to locate to the beginning of the song (00:00:00:00) using the Return To Zero function (RTZ). (See “Returning to the song beginning (RTZ function)” or the point where recording was last started (LRP function)” on page 64.)

19 **Stop (■) button**

Press to stop playback, recording and searching backward/forward. Press together with the ◀◀ [RTZ] button or the ▶▶ [LRP] button to locate to the beginning of the song (00h00m00s00f) or the last recording point (LRP). (See “Returning to the song beginning (RTZ function)” or the point where recording was last started (LRP function)” on page 64.)

20 **▶▶ [LRP] button**

Press when stopped or playing back to search forward. Press it again to change the speed from 10x to 50x, again for 100x and 1000x.

Press while pressing and holding the Stop (■) button to locate to the point when recording last started using the Last Recording Position (LRP) function. (See “Returning to the song beginning (RTZ function)” or the point where recording was last started (LRP function)” on page 64.)

21 **Play (▶) button**

Press this button to start playback. While pressing the Record (●) button, press this button to start recording. Press this button again when recording to stop recording and start playback (punch out).

3 – Names and functions of parts

22 Record (●) button / indicator

Press the PLAY (▶) button while pressing this button to start recording. The indicator lights when recording. If you press this button when any of the track **REC** indicators is lit, or during playback, recording will begin (punch in). (See “Punching in and out” on page 61.)

Front panel

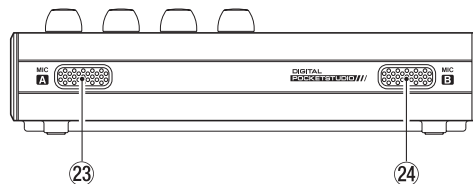

23 MIC A

This built-in microphone is omnidirectional.

This internal mic can be set as the input source for **INPUT A** (INT.MIC A-Low, INT.MIC A-Mid or INT.MIC A-High).

24 MIC B

This built-in microphone is omnidirectional.

This internal mic can be set as the input source for **INPUT B** (INT.MIC A-Low, INT.MIC A-Mid or INT.MIC A-High).

3 – Names and functions of parts

Rear panel

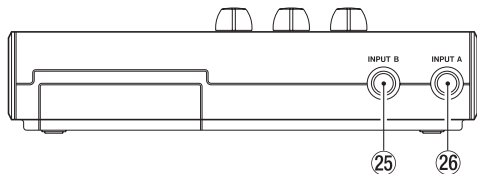

25 INPUT B (standard jack)

Use this jack for a line level or mic signal (unbalanced connection). Use this as an input source by setting IN-B (INPUT B) on the INPUT SETTING screen for a line level input (LINE, LINE Mid or LINE High) or an external mic (MIC).

26 INPUT A (standard jack)

Use this jack for a guitar, line level or mic signal (unbalanced connection). Use this as an input source by setting IN-A (INPUT A) on the INPUT SETTING screen for a guitar or line level input (GUITAR/LINE, GUITAR/LINE M or GUITAR/LINE H) or an external mic (MIC). Set the MIC/LINE-GUITAR switch on the left side of the unit according to the input source.

Left side panel

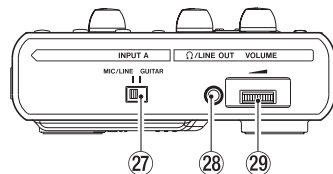

27 MIC/LINE-GUITAR switch

Set this switch to match the input signal to the INPUT A jack on the rear panel. For mic or line signals, set it to MIC/LINE. For electric guitars and basses that are connected directly, set it to GUITAR.

TIP

When connecting an electric-acoustic guitar with a built-in preamp or an active electric guitar, as well as when connecting an electric guitar with effect boxes between it and this unit, set the MIC/LINE-GUITAR switch to MIC/LINE.

28 Ω /LINE OUT jack (stereo mini jack)

Connect headphones or an external monitoring system (powered monitor speakers or an amplifier and speakers) here.

29 The VOLUME dial

Use to adjust the volume output from the Ω /LINE OUT jack.

CAUTION

The VOLUME dial does not have any indications. Before turning the power ON, always turn it in the direction of the arrow until it stops to minimize the volume. Sudden bursts of loud sounds can cause hearing damage and speaker damage, for example.

3 – Names and functions of parts

Right side panel

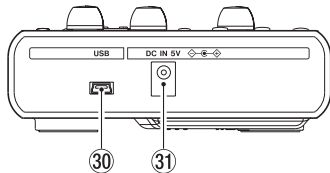

30 USB connector

Connect the unit to a computer using the included USB cable. This allows for sharing, importing and exporting files between the unit and the computer, including backup of the song files. (See “Connecting with a computer” on page 84.)

31 DC IN 5V connector

Connect a dedicated power adaptor (PS-P520, sold separately).

Bottom panel

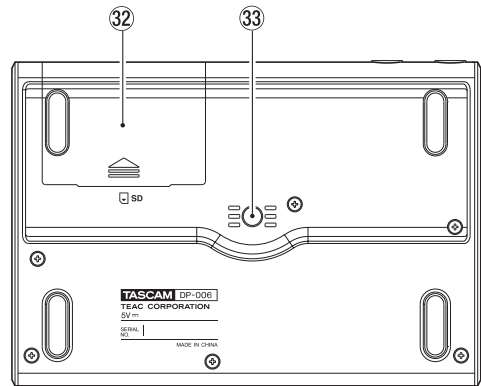

32 Battery compartment cover

33 Tripod screw thread (1/4-inch)

Use this to mount the unit on a tripod.

CAUTION

- To prevent this unit from falling, thoroughly tighten the mounting and adjustment screws of the tripod or mic stand.
- When using this unit mounted on a tripod or mic stand, place the tripod or mic stand on a level surface.
- Depending on the tripod, the size of the screw might be different and directly mounting the unit on it might not be possible. In such cases, use a commercially-available adapter.

3 – Names and functions of parts

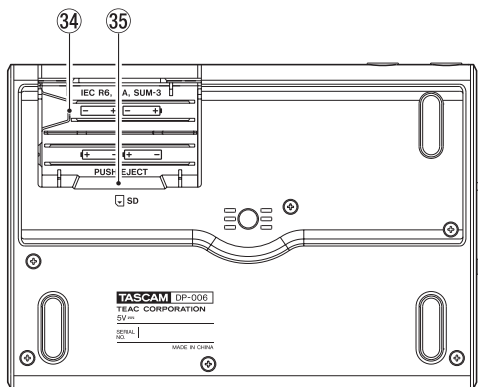

34 Battery compartment

The batteries (four AA) that power the unit are inserted here. The SD card slot is in the back of the compartment.

35 SD card slot

Insert SD cards into this slot.

Home Screen

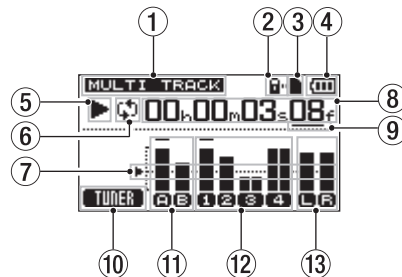

1 Recorder mode



Shows the current recorder mode.

Indication	Recorder mode
MULTI TRACK	Multitrack recording mode
BOUNCE	Bounce mode
MASTER REC	Master recording mode
MASTER PLAY	Master playback mode

2 SD card write-protection indicator

If the SD card write-protection switch is set to "Lock", the  icon appears here.



3 SD card insertion status

When an SD card is loaded in the unit, the  icon appears here. (The  icon appears when no card is loaded in the unit.)

4 Battery status

A battery icon appears when the unit is being powered by batteries.

3 – Names and functions of parts





When a battery is being used, a battery icon shows the amount of power remaining in bars ( ,  , ).

When the batteries are almost dead and the power will soon turn off, an  icon with no bars appears blinking.

When using the AC adapter (sold separately)  appears.

⑤ Recorder transport state

One of the following icons appears depending on the status of the recorder.

Indicator	Meaning
	Stopped
	Playing back
	Recording
	Searching backward
	Searching forward

⑥ Repeat playback mode indicator

When repeat playback is active  appears.

⑦ Level meter guide

This guideline for adjusting input and output levels indicates -12 dB.

⑧ Recorder time counter

Shows the elapsed time from the start of the song.

⑨ Cursor that shows time increment being edited

When the unit is stopped press the **HOME** button to move the cursor between time counter divisions.

Turn the **DATA** wheel to change the value of the underlined time increment.

⑩ Shows the F1 button function



When that Home Screen is open, press the **F1** [TUNER] button to open the TUNER screen.



⑪ INPUT A and B Level meters

These show this input source signal levels of **INPUT A** () and **INPUT B** ().

⑫ TRACK 1-4 level meters

Shows the input level when recording and the playback signal level when playing back.

Depending on the track type setting, the size of the level meter icons and width of the level meters for **TRACK 3** () and **TRACK 4** () changes.

Track type	Level meter icons
STEREO	
MONO	

⑬ Level meter for stereo outputs (L, R)

Shows the output signal level from the  **LINE OUT** connector.

3 – Names and functions of parts

Menu structure

Press the **MENU** button to open the **MENU** screen.

The menu items are as follows.

Menu item	Function	Reference
INFORMATION	View information about files, SD cards and the system.	page 78
SONG	Manage songs, including loading and saving them and creating new ones.	page 45
CARD	Format SD cards, etc.	page 79
TRACK TYPE	Set the track type for TRACK 3 and TRACK 4.	page 54
TRACK EDIT	Edit tracks.	page 67
DATA BACKUP	Back up and restore songs.	page 86
IMPORT/EXPORT	Import and export tracks and export master tracks.	page 88
METRONOME	Make metronome settings.	page 75
PREFERENCE	Adjust the contrast, repeat playback interval, and auto power save settings and initialize the backup memory, for example.	page 44 page 66 page 77

Dedicated buttons can be used to directly access some setting screens as follows.

Button	Function	Reference
INPUT SETTING	Select the input source.	page 51
ASSIGN	Assign INPUT A or B to a track as its recording source.	page 54
REPEAT	Repeat playback between the set IN and OUT points.	page 65
IN/OUT	Set the IN and OUT points.	page 65
REC MODE	Create and adjust stereo master tracks.	page 42
UN/REDO	Undo the last action and redo the last undo.	page 58
STOP (■) + UN/REDO	Show the undo/redo history and select operations.	page 58

3 – Names and functions of parts

Screen operations

After using the **MENU** button or a dedicated button to open a screen, use the screen in the following manner.

This section describes the basic operation procedures. Depending on the screen that is open the assignments of the function buttons might differ.

NOTE

During playback or recording, you cannot open screens that might access the SD card. If you try to open one of these screens, a Not Stopped (the recorder is not stopped) pop-up message will appear.

Function buttons

The currently assigned function of each button is shown above it at the bottom of the screen. In this manual, for convenience, we refer to the function buttons as **F1**, **F2**, **F3** and **F4** in order from the left.



BACK appears above the **F1** button, showing that this is the function assigned to this button on the screen. In this manual, we write this as “**F1** [BACK] button”.

In a similar manner the assignments for the **F2**, **F3** and **F4** buttons are **EXEC**, **INS** and **DEL** in that order.

- Use the **DATA** wheel to select (highlight) items you want to access.

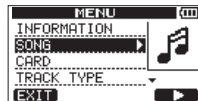

This example shows the **MENU** screen.

On the screen, the **SONG** item is selected (highlighted).

- If there are more items above the top item in the list currently shown, an ▲ icon appears. If there are more below the bottom item, a ▼ icon appears. (In the **MENU** screen shown above, the ▼ shows that there is at least one more item below **TRACK TYPE**.)
- If an item has a submenu (as on the **MENU** screen, for example), an ► appears to its right, and pressing the **F4** [►] button will open it.
- In a submenu, you can press the **F1** [BACK] button to return to the previous screen.

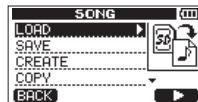

3 – Names and functions of parts

- To execute an operation, press the function button that has EXEC assigned to it.

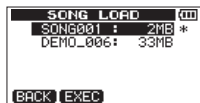

This example shows the **SONG LOAD** screen.

Press the **F2 [EXEC]** button to load the selected (highlighted) song.

- When a setting value is selected (highlighted), use the **DATA** wheel to change the value.

To select (highlight) different item press the function button that has **▲** or **▼** assigned to it.

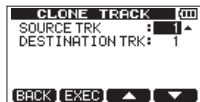

This example shows the **CLONE TRACK** screen.

Use the **DATA** wheel to change the **SOURCE TRK** (the track that is being copied) value.

Use the **F3 [▲]** and **F4 [▼]** buttons to move up and down to change the selected (highlighted) item.

Press the **F2 [EXEC]** button to clone the track using the settings that you made.

- When moving left or right is possible, use the **◀ [RTZ]** and **▶ [LRP]** buttons. When this operation is possible, an illustration on the screen shows the assignment of the **◀** and **▶** buttons to cursor movement.



- To continue to the next operation, press the **F4 [NEXT]** button.

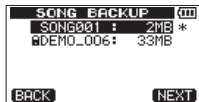

- To leave a screen that was accessed using a dedicated button, press the **F1 [EXIT]** button.



- To return to the Home Screen, press the **HOME** button.

4 – Preparations

Preparing the power and SD card

Inserting an SD card

Insert the SD card into the SD card slot inside the battery compartment on the bottom of the unit.

1. Open the cover of the battery compartment on the bottom of the unit. If batteries are inside the compartment, confirm that the power is OFF (standby mode) and remove the batteries.
2. Insert the SD Card into the SD card slot inside the battery case in the direction shown in the following illustration until it clicks into place.

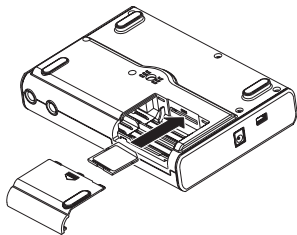

3. Close the cover after inserting the SD card. Replace the batteries if you are using them and close the cover.

Removing an SD card

Push a loaded SD card in further to eject it.

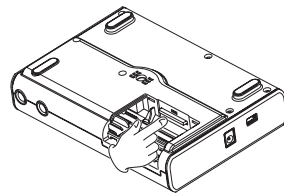

CAUTION

- Always turn the power OFF (standby) before removing or inserting an SD card. Failure to power off properly first will cause recordings and settings made since the last power off and song save to be lost. This data cannot be recovered.
- SD cards that meet SD/SDHC standards and are at least 512 MB can be used with this unit.
- A list of SD cards that have been confirmed for use with this unit can be found on the TASCAM website (<http://tascam.com/>).

SD card write-protection switches

SD cards have write-protection switches.

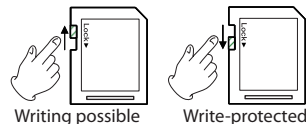

When a write-protection switch is set to the "LOCK" position, you will not be able to write files to the card or edit files on it. To record on a card or erase files on it, for example, disable its write-protection.

4 – Preparations

Preparing the power

This unit can be powered either by 4 AA batteries or using a TASCAM PS-P520 AC adaptor (sold separately).

Alkaline or NiMH AA batteries can be used with this unit.

■ Using batteries

Open the cover of the battery case on the bottom of the unit as described in "Inserting an SD card" on the previous page. Insert 4 AA batteries in the box according to the ⊕ and ⊖ indications.

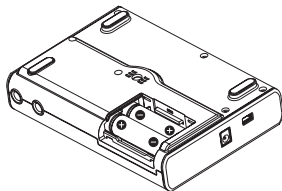

CAUTION

- *Manganese AA batteries cannot be used with this unit.*
- *This unit cannot charge nickel-metal hydride batteries. Use a commercially-available recharger.*
- *The included alkaline batteries are for confirming the operation of the unit and might not last very long.*
- *Remove the batteries if you do not plan to use the unit for some time. Leaving the batteries in could cause them to be used gradually and lose their charge or even to leak.*

■ Using an AC adaptor (sold separately)

Connect a TASCAM PS-P520 AC adaptor (sold separately) to the **DC IN 5V** connector as shown in the illustration.

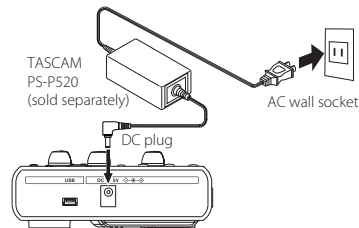

CAUTION



- *Use only the PS-P520 AC adaptor (sold separately). Using any other AC adaptor could cause malfunction, fire or electric shock.*
- *This unit can be powered by batteries or an AC adaptor. Power cannot be supplied to this unit over USB.*

NOTE

The adapter powers the unit if the adapter is connected even if batteries are installed.

Start-up & shutdown

Starting up the unit

Press and hold the  button on the top panel until "TASCAM" appears (or the  button indicator lights green).

After the start-up screen, the Home Screen appears.



Start-up screen



Home Screen

This unit always starts up in MULTI TRACK recorder mode regardless of the mode used last before shutting down.



CAUTION

- Before turning the power ON or OFF (putting it into standby), minimize the volume on any connected external monitoring system (powered monitor speakers or an amplifier and speakers).
- Do not wear headphones when turning the power ON or OFF (putting it into standby) because noise at such times could harm your hearing.

Shutting down

Make the following preparations before shutting down the unit.

- Stop the recorder. (The unit cannot be shut down during recording, playback, search forward, etc.)
- Return to the Home Screen.
- If the unit is connected to computer, disconnect the USB cable after conducting the necessary procedures on the computer to unmount the unit.

After making these preparations, press and hold the  button until the following screen appears (or the  button indicator light begins to blink).



The power turns off after the unit completes its shutdown process, including saving various information from your session.

CAUTION

- Do not remove the batteries or disconnect the power cable accidentally while the unit is operating. If you do so, the unit cannot shut down properly and all unsaved data will be lost. Lost data cannot be restored. We recommend that you also save the data manually often.
- When the power is turned OFF (put in standby mode), the operation history of the currently loaded song will be completely erased. You will not be able to undo or redo past song operations when you turn the power back ON.

4 – Preparations

Preparing SD cards for use

To use a new SD card with this unit, it is necessary to format it first. SD cards formatted by the unit are divided into MTR partitions and FAT partitions. SD cards with high capacities can be formatted with multiple partitions.

For more information about partitions see “9 – Mixdown and mastering” on page 72.

NOTE

The included SD card is already formatted so formatting is not necessary. If you format this card the demo song on it will be erased.

1. The first time you insert a new SD card in this unit, the following pop-up message prompting you to format it appears.



NOTE

The pop-up message prompting you to format it also appears if you insert an SD card that has been formatted by any device other than this unit.

CAUTION

If you format it, all data saved by the other device will be erased and you will not be able to recover it.

2. Press the **F3** [YES] button to format the SD card with the standard number of partitions for the card capacity.
The Home Screen appears after the format completes correctly.

NOTE

- To cancel formatting press the **F4** [NO] button.
- Depending on the SD card capacity, the partition setting can be changed in some cases. To do so, set the partition size using the **FORMAT** item in the **CARD** menu before formatting. (See “9 – Mixdown and mastering” on page 72.)

Recorder modes

This unit has four recorder modes.

MULTI TRACK

Use the unit as a multitrack recorder.

BOUNCE

Use to bounce tracks. (See “Bouncing tracks” on page 61.)

MASTER REC

Use to create mixed stereo master tracks. (See “Mixdown” on page 72.), (See “Creating stereo master tracks” on page 72.)

MASTER PLAY

Use to play created stereo master tracks. (See “Checking stereo master tracks” on page 74.)

When the power is turned ON, the unit always starts in **MULTI TRACK** mode.

When in recorder modes other than **MULTI TRACK** mode, many screen operations are disabled.

In this Owner's Manual, unless otherwise noted, the recorder mode explained is assumed to be the **MULTI TRACK** mode.

Connecting with other equipment

This section shows examples of connections that can be made with this unit.

■ Precautions before making connections

- Turn the power OFF (or put in standby) for this unit and all other equipment that you will connect to it.
- Set up all the equipment so that all units are powered from the same line. When using a power strip, for example, use a thick cable with a high current capacity to reduce fluctuation of the power voltage.

Rear panel connections

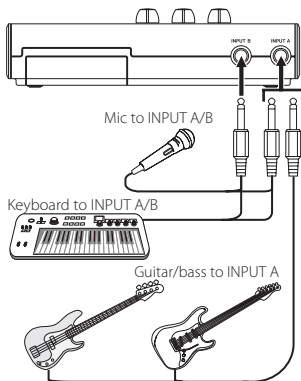

Left side panel connections

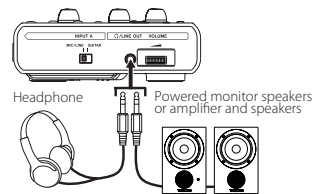

NOTE

*Before outputting sound, use the **VOLUME** dial of any external monitoring system (powered monitor speakers or an amplifier and speakers) connected to the unit. Failure to do so could cause loud noises that might harm your hearing.*

4 – Preparations

Right side panel connections

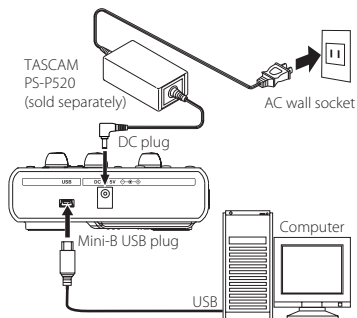

NOTE

- Recorder functions cannot be used when connected to a computer by USB.
- This unit can only be connected to a computer by USB when the recorder mode is set to MULTI TRACK.

Adjusting the contrast

You can adjust the contrast of the display.
Follow these steps to adjust the contrast.

1. When the recorder is stopped, press the **MENU** button to open the MENU screen.
2. Use the **DATA** wheel to select (highlight) the PREFERENCE item, and press the **F4** [▶] button to open the PREFERENCE screen.

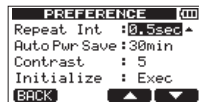

3. Use the **F3** [▲] and **F4** [▼] buttons to select the Contrast item, and use the **DATA** wheel to adjust the display contrast.

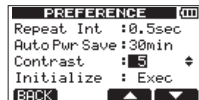

The setting values are 1–10 (default value: 5).

Lower values make the display lighter while higher values make it darker. The display appears different depending on the angle from which you view it, so adjust it while the unit is in the actual position that you plan to use it in. Adjusting the contrast might make it easier to read.

4. After completing the setting, press the **HOME** button to return to the Home Screen.

5 – Song Management

This unit manages data in units called “songs”. Ordinarily, each real song is one “song” unit. The first step when using this recorder is to load the song that you want. (You can load an existing song or create a new song.)

The recorded multitrack (**TRACK 1–4**) and stereo master track are saved in each song.

This chapter, starts with an explanation of the two types of SD card partitions, and then covers basic operations, including song loading and creation, as well as various song management functions.

Partitions and songs

This unit uses SD cards to record songs. SD cards formatted by the unit are divided into two (or more) partitions.

This unit uses an “MTR partition” to store song data and a “FAT partition” that can be read by computers. SD cards with high capacities might be formatted with multiple MTR partitions.

When you want to record, playback or edit a song, select an MTR partition to make it the active partition and load a song on it or create a new song.

Selecting the active partition

If you want to use a file that is on a partition other than the currently active partition in order to load an existing song or create a new song on it, you must change the partition.

Follow these steps to select a partition on an SD card that has multiple MTR partitions.

1. When the recorder is stopped, press the **MENU** button to open the **MENU** screen.
2. Use the **DATA** wheel to select (highlight) the **CARD** item, and press the **F4** [▶] button to open the **CARD** menu screen.

3. Use the **DATA** wheel to select (highlight) the **PARTITION** item, and press the **F4** [▶] button to open the **PARTITION** screen.

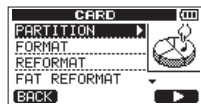

This screen shows a list of the MTR partitions.

The active partition is shown with an asterisk (*) on the right side. The sizes of the MTR partitions are shown (not available space).

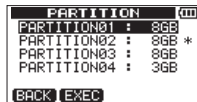
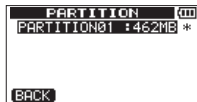

SD card with one MTR partition SD card with multiple MTR partitions

4. Use the **DATA** wheel to select the desired partition, and press the **F2** [EXEC] button.

Are you sure? appears as a confirmation pop-up message.



5. Press the **F3** [YES] button.

The unit saves the current song before changing partitions. It then loads the last used song on that partition.

5 – Song Management

Editing names

You can edit names (titles) on the following screens.

When saving, creating or editing the name of a song

SONG SAVE, SONG CREATE and NAME EDIT screens

When backing up a song

SONG BACKUP screen

When exporting WAV files

EXPORT MASTER screen



NAME EDIT screen

You can edit the name as follows.

- Use the ◀◀ [RTZ] button and ▶▶ [LRP] button to move the cursor (underline) position. The cursor position is where editing occurs.
- Use the **DATA** wheel to change the underlined character. On the SONG SAVE, SONG CREATE and NAME EDIT screens, ordinary symbols, numerals and upper and lower case English letters can be input. On the SONG BACKUP, EXPORT TRACK and EXPORT MASTER screens, lower case English letters can be input.
- On the SONG SAVE, SONG CREATE and NAME EDIT screens, press the **F3** [INS] button to insert a blank at the cursor position. On the SONG BACKUP, EXPORT TRACK and EXPORT MASTER screens, press the **F3** [INS] button to insert the letter A at the cursor position.
- Press the **F4** [DEL] button to delete the character at the cursor position.

- When finished inputting or editing a name (title), press the **F2** [EXEC] button to save it.

Loading a saved song

Follow these steps to load the song that you want from the active partition.

1. When the recorder is stopped, press the **MENU** button to open the MENU screen.
2. Use the **DATA** wheel to select (highlight) the SONG item, and press the **F4** [▶] button to open the SONG menu screen.
3. Use the **DATA** wheel to select (highlight) the LOAD item, and press the **F4** [▶] button to open the SONG LOAD screen.

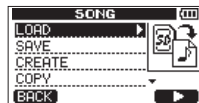

A list of the songs on the active MTR partition is shown.



The currently loaded song is shown with an asterisk (*) to the right of the song size. An SD icon appears on the left side of a protected song.

4. Use the **DATA** wheel to select (highlight) the desired song, and press the **F2** [EXEC] button. The current song is saved, and the selected song is loaded.
5. Press the **HOME** button to open the Home Screen.

Creating a new song

Follow these steps to create a new song in the active partition.

1. When the recorder is stopped, press the **MENU** button to open the MENU screen.
2. Use the **DATA** wheel to select (highlight) the **SONG** item, and press the **F4** [▶] button to open the **SONG** menu screen.

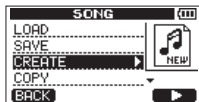

3. Use the **DATA** wheel to select (highlight) the **CREATE** item, and press the **F4** [▶] button to open the **SONG CREATE** screen.



The default song name (title) given to new songs is "SONG****". (The asterisks indicate a number. In the example above the name is "SONG002".)

4. Change the song name as necessary. (See "Editing names" on page 46.)

TIP

You can rename a song later by selecting NAME EDIT item from the SONG menu screen. You can also edit the song name when saving it.

5. Press the **F2** [EXEC] button to save the currently loaded song and create a new song.
6. Press the **HOME** button to open the Home Screen.

Saving a song

This unit automatically saves the current song when loading another song and during shutdown (when it stores various information about operations conducted to that point). You can also save a song at any time using the following procedures.

1. When the recorder is stopped, press the **MENU** button to open the MENU screen.
2. Use the **DATA** wheel to select (highlight) the **SONG** item, and press the **F4** [▶] button to open the **SONG** menu screen.

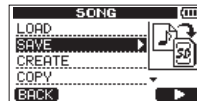

3. Use the **DATA** wheel to select (highlight) the **SAVE** item, and press the **F4** [▶] button to open the **SONG SAVE** screen.



4. Change the song name as necessary. (See "Editing names" on page 46.) To save it as is, press the **F2** [EXEC] button.

A **Storing Song** pop-up message appears while the song is being saved. A **SONG Save Complete** pop-up message appears when it is done, and the **SONG** menu screen reopens.

5. Press the **HOME** button to open the Home Screen.

5 – Song Management

Viewing song information

You can check the name (title), MTR partition and remaining recording time of the currently loaded song on the SONG (1/4) page of the INFORMATION screen. (See “Viewing information” on page 78.)

1. When the recorder is stopped, press the **MENU** button to open the MENU screen.
2. Use the **DATA** wheel to select (highlight) the **INFORMATION** item, and press the **F4 [▶]** button.

This opens the SONG (1/4) page of the INFORMATION screen, which shows the name and remaining recording time of the current song.

NOTE

The INFORMATION screen has four pages, including SONG (1/4), CARD (2/4), SYSTEM (3/4) and F/W (4/4). Use the **F3 [PREV]** and **F4 [NEXT]** buttons to change the page. (See “Viewing information” on page 78.)

Copying songs

Songs in the currently active partition can be copied to the same and different MTR partitions. Multiple songs can also be copied at once.

1. When the recorder is stopped, press the **MENU** button to open the MENU screen.
2. Use the **DATA** wheel to select (highlight) the **SONG** item, and press the **F4 [▶]** button to open the SONG menu screen.
3. Use the **DATA** wheel to select (highlight) the **COPY** item, and press the **F4 [▶]** button to open the SONG COPY screen.



A list of songs on the active partition is shown.

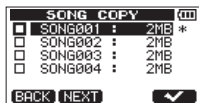

4. Use the **DATA** wheel to select (highlight) the song you want copy, and press the **F4 [✓]** button.

The song is selected as a copy source and a check appears in the checkbox.

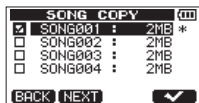

NOTE

To remove a ✓ from the checkbox, press the **F4** [✓] button while the song is selected.

- To copy multiple songs, repeat step 4.
- After selecting all the songs to copy (by putting ✓ marks in their checkboxes), press the **F2** [NEXT] button.

The copy destination partition is shown.



In addition, the amount of open space on the selected MTR partition (Free) and the size of the song data (Total) are shown.

If the open space (Free) is less than the song data, copying is not possible. (If you try to execute it, a No Disk Space pop-up message appears to warn you that there is not enough free space in the partition.)

- Use the **DATA** wheel to select the copy destination MTR partition, and press the **F4** [EXEC] button.

When copying completes, the SONG menu screen reopens.

NOTE

To cancel song copying, press the **F1** [BACK] button.

- Press the **HOME** button to open the Home Screen.

Erasing songs

Songs can be erased. You can also erase multiple songs at once. You might want to erase unneeded songs if the SD card starts to run out of open space.

- When the recorder is stopped, press the **MENU** button to open the MENU screen.
- Use the **DATA** wheel to select (highlight) the SONG item, and press the **F4** [▶] button to open the SONG menu screen.
- Use the **DATA** wheel to select (highlight) the ERASE item, and press the **F4** [▶] button to open the SONG ERASE screen.



A list of songs on the active partition is shown.

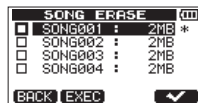

- Use the **DATA** wheel to select (highlight) the song you want to delete, and press the **F4** [✓] button.

A check appears in the checkbox.



NOTE

To remove a ✓ from the checkbox, press the **F4** [✓] button while the song is selected.

5 – Song Management

- To erase multiple songs, repeat step 4.
- After selecting all songs that you want to erase (adding ✓ to their check-boxes), press the **F2** [EXEC] button.
A confirmation pop-up message appears.



- Press the **F3** [YES] button.
After the songs are erased, the **SONG** menu screen reopens.

NOTE

To cancel song erasing, press the **F4** [NO] button.

- Press the **HOME** button to open the Home Screen.

NOTE

Every MTR partition must always have at least one song, so if you erase all the songs on a partition, a new song is created automatically.

Protecting songs

If you protect a song, editing, recording, and erasing of that song is prohibited.

- When the recorder is stopped, press the **MENU** button to open the **MENU** screen.
- Use the **DATA** wheel to select (highlight) the **SONG** item, and press the **F4** [▶] button to open the **SONG** menu screen.



- Use the **DATA** wheel to select (highlight) the **PROTECT** item, and press the **F4** [▶] button to open the **SONG PROTECT** screen where you can turn song protection ON and OFF.

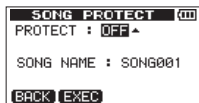

- Use the **DATA** wheel to set the **PROTECT** item to ON, and press the **F2** [EXEC] button.
After song protection is turned ON, the **SONG** menu screen reopens.

NOTE

- When the song list is used to, for example, copy or erase, a padlock icon appears next to protected songs.
- If you try to execute a prohibited operation (edit, record, erase) on a protected song, pop-up message Song Protected appears and the operation is prevented.
- To remove protection from a song, follow the above procedures but set **PROTECT** item to OFF in step 4.

Selecting the input source

This unit has two inputs (**INPUT A/B**) that can be selected separately as input sources.

The built-in microphones (front panel MIC A/B) and external input signals (input through the rear panel **INPUT A/B** jacks) can be selected as input sources.

Mic, line and guitar signals can be input through the **INPUT A** standard jack.

Set the **MIC/LINE-GUITAR** switch on the left side of the unit to **GUITAR**.

1. When the recorder is stopped, press the **INPUT SETTING** button to open the **INPUT SETTING** screen.



Use the **IN A** and **IN B** items to set the input sources for **INPUT A** and **INPUT B**.

2. Use the **F3** [**▲**] and **F4** [**▼**] buttons to select (highlight) the **IN A** or **IN B** setting value, and use the **DATA** wheel to set the input source.

IN A options

Option	Description
OFF	Input off
INT.MIC A-Low (default value)	Built-in mic A (low input gain)
INT.MIC A-Mid	Built-in mic A (medium input gain)
INT.MIC A-High	Built-in mic A (high input gain)
GUITAR/LINE	Guitar or line through INPUT A jack (low input gain)
GUITAR/LINE M	Guitar or line through INPUT A jack (medium input gain)
GUITAR/LINE H	Guitar or line through INPUT A jack (high input gain)
MIC	Mic through INPUT A jack

IN B options

Option	Description
OFF	Input off
INT.MIC B-Low (default value)	Built-in mic B (low input gain)
INT.MIC B-Mid	Built-in mic B (medium input gain)
INT.MIC B-High	Built-in mic B (high input gain)
LINE	Line through INPUT B jack (low input gain)
LINE Mid	Line through INPUT B jack (medium input gain)
LINE High	Line through INPUT B jack (high input gain)
MIC	Mic through INPUT B jack

3. After making the setting, press the **HOME** button to return to the Home Screen.

6 – Basic Recording

- If a source that uses the **INPUT A** connector is selected as the **INPUT A** input source in step 2 above, set the **MIC/LINE-GUITAR** switch on the left side panel appropriately. Set it to **GUITAR** when connecting an electric guitar or electric bass directly. Set it to **MIC/LINE** when inputting a mic or line signal.

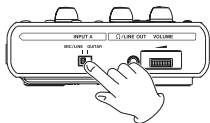

TIP

*When connecting an electric-acoustic guitar with a built-in preamp or an active electric guitar, as well as when connecting an electric guitar with effect boxes between it and this unit, set the **MIC/LINE-GUITAR** switch to **MIC/LINE**.*

Monitoring the input signal

When an input source is set as the **INPUT A** or **INPUT B** connector on the rear panel, regardless of the **REC** button setting, the input signal is always sent to the stereo bus, so you can always monitor the input signal.

When an input source is set to a front panel built-in mic, the input signal is sent to the stereo bus and can be monitored only when the **REC** indicator light for the track that is set to record the built-in mic is blinking (during record standby) or lit (while recording). You cannot monitor the built-in mic input when the **REC** indicator is not lit.

NOTE

*When an input source is set as the **INPUT A** or **INPUT B** connector, during playback, the sounds of the playback signal and the input source are mixed and can be heard through headphones or a monitoring system connected to the **LINE OUT** connector.*

Setting the monitoring mode

The monitoring mode can be set for the **INPUT A/B** signals.

- When the recorder is stopped, press the **INPUT SETTING** button to open the **INPUT SETTING** screen.



- Use the **F3** [**▲**] and **F4** [**▼**] buttons to select the **MODE** item value, and use the **DATA** wheel to select (highlight) the input signal monitor mode.
MONOx2: **INPUT A/B** signals are output as mono signals from left and right channels.
STEREO: **INPUT A/B** signals are output as left and right channels.
- After completing the setting, press the **HOME** button to return to the Home Screen.

OL indicators and level meters

The audio levels of this unit can be checked using the **INPUT A/B OL** indicators and the level meters on the display.

The level meters allow the signal levels to be checked, and they can also be used to confirm whether signals are being input into the unit. For example, if the **A** and **B** level meters are moving a signal is being input into the unit even if you cannot hear anything when you are monitoring with headphones or an external monitoring system (powered monitor speakers or an amplifier and speakers). In this case, something other than this unit is probably the reason that sound is not being output.

As shown below, if a “-” appears at the top of a level meter, the input is overloading (these “-” indicators will automatically disappear after a while). In this case, the sound might be distorted, so lower the level until the “-” stops appearing.

If an **OL** indicator lights, the input source signal could be too loud or the **LEVEL** knob set too high.

If the **OL** indicator lights even if the **LEVEL** knob is set to **MIN**, the input source signal is too high, so lower the volume on the input source.

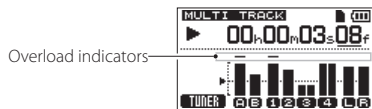

Input level meters (A/B)

The **A** and **B** level meters on the display show the input levels of this unit's **INPUT A** and **INPUT B**.

Use the **INPUT A/B LEVEL** knobs, **INPUT SETTING** screen settings and the output volume controls of the input sound source to adjust the levels.

NOTE

*If an **INPUT A/B OL** indicator lights even though the **INPUT A/B** level meters shows a suitable level, the input signal is too strong and the sound is distorted. Lower the output volume of the input sound source.*

TRACK level meters (1–4)

These meters show either playback signal levels or the track input signal levels, depending on the operation status, as shown below.

REC indicator	Transport status	Signals shown by level meters
Unlit	Playing back	Track playback
Blinking (recording standby)	Playing back	Track playback
	Stopped	Track input
Lit (recording)	Recording	Track input

NOTE

*When the playback signal is shown, the level of the recorded signal of the track is shown, so the level shown by the meters cannot be changed. When the input signal is being shown, the **INPUT A/B LEVEL** knobs can change the levels shown by the level meters.*

Stereo level meters (L/R)

These show the stereo bus output level of this unit. Adjust the output level with the **MASTER LEVEL** knob.

NOTE

*When an input source is a built-in mic, if the **REC** indicator is not lit on a track that has the built-in mic as its recording source, the input sound cannot be heard.*

6 – Basic Recording

Assigning inputs

When using this unit, “assigning inputs” means setting the recording source for each track using the **INPUT ASSIGN** screen.

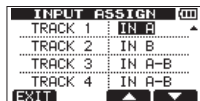

NOTE

- The illustration above shows the default values.
- Assignment settings are saved when songs are saved and when the power is turned OFF (put into standby). Moreover, assignment settings are loaded when songs are loaded.

This unit can simultaneously record a maximum of two tracks. You can also record one input channel to two tracks simultaneously (in this case, you cannot use the other input channel).

You cannot assign two inputs to the same track.

Setting the track type (Tracks 3 and 4 only)

Tracks 3 and 4 can each be used separately as stereo or mono tracks. Make this setting on the **TRACK TYPE** screen.

1. When the recorder is stopped, press the **MENU** button to open the **MENU** screen.

2. Use the **DATA** wheel to select (highlight) the **TRACK TYPE** item, and press the **F4** [▶] button to open the **TRACK TYPE** screen.

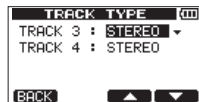

3. Use the **F3** [▲] and **F4** [▼] buttons to select (highlight) the track type value of the track that you want to change, and use the **DATA** wheel to change the value.

STEREO (default value): Use as a stereo track.

MONO: Use as a mono track.

4. Press the **F2** [EXEC] button.

A confirmation pop-up message appears.

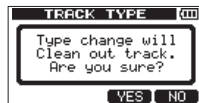

5. Press the **F3** [YES] button to confirm the track type change.
6. After completing the setting, the **MENU** screen reopens.
7. After completing the setting, press the **HOME** button to return to the Home Screen.

CAUTION

Changing the track type will clear all recordings on it, leaving silence. However, undoing will restore the track type and the original recordings on it. (See “Undoing operations (undo)” on page 58.)

Assigning inputs to stereo tracks (Tracks 3 and 4 only)

1. On the TRACK TYPE screen, set TRACK 3 and/or TRACK 4 to STEREO. (See “Setting the track type (Tracks 3 and 4 only)” on page 54.)
2. When the recorder is stopped, press the **ASSIGN** button to open the INPUT ASSIGN screen.

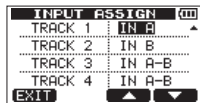

3. Use the **F3** [▲] button and **F4** [▼] buttons to select (highlight) the setting value for TRACK 3 or TRACK 4.
4. Use the **DATA** wheel to set the input source of the TRACK 3 or TRACK 4 stereo track.

Setting values: IN A-A, IN A-B (default value), IN B-A, IN B-B

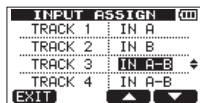

5. After making the setting, press the **HOME** button to return to the Home Screen.

NOTE

Both left and right channels of stereo tracks (TRACK 3 and/or TRACK 4) will be recorded to at the same time. Recording to just the left or just the right channel is not possible.

TIP

You can record to track 1 and track 2 separately and then clone (copy) them together as a stereo pair to the left and right channels of track 3 or 4. In this way, you can record their left and right channels separately. (See “CLONE TRACK (track duplication)” on page 69.)

6 – Basic Recording

Assigning inputs to mono tracks

1. On the **TRACK TYPE** screen, set **TRACK 3** and/or **TRACK 4** to **MONO**. (See “Setting the track type (Tracks 3 and 4 only)” on page 54.)
2. When the recorder is stopped, press the **ASSIGN** button to open the **INPUT ASSIGN** screen.

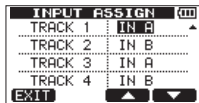

3. Use the **F3** [**▲**] and **F4** [**▼**] buttons to select (highlight) the setting value for the track you want to set.
4. Use the **DATA** wheel to set the input source of the mono track.
Setting values: **IN A** (default value for **TRACK 1** and **TRACK 3**), **IN B** (default value for **TRACK 2** and **TRACK 4**)

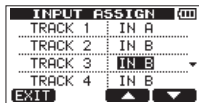

5. After making the setting, press the **HOME** button to return to the Home Screen.

Making the first recording

Before beginning the following recording procedures, connect a recording source (guitar, keyboard, etc.) to an input, assign that input as the recording source for a track and connect headphones or an external monitoring system (powered monitor speakers or an amplifier and speakers).

1. Press the **REC** button of a track to put it into recording standby. Its **REC** indicator blinks.

A maximum of two tracks can be recorded simultaneously.

If you press a different **REC** button when the **REC** indicators of two tracks are already blinking, the track that was put into record standby first will become inactive and the **REC** indicator will turn off.

For example, if you press the **REC** buttons for **TRACK 1**, **TRACK 2** and **TRACK 3** (stereo track) in that order, **TRACK 1** and **TRACK 2** will no longer be in record standby, but stereo **TRACK 3**, which was pressed last, will be in record standby. If **TRACK 3** is set to mono, however, **TRACK 1**, which was pressed first, will no longer be in record standby, but **TRACK 2** and **TRACK 3**, which were pressed after, will be in record standby.

2. Set the recording level.

Use the **INPUT A/B LEVEL** knobs to adjust the input levels.

Watch the display **(A)** and **(B)** level meters and the **OL** indicators above and to the left of the **LEVEL** knobs while setting their levels suitably.

At the same time, confirm that the sound you hear from the headphones or an external monitoring system (powered monitor speakers or an amplifier and speakers) is not distorted.

NOTE

*The level meters of tracks with assigned input sources move in the same way as the **INPUT A/B LEVEL** meters **(A)** and **(B)**. The **OL** indicator lights if the input is too loud. If the **OL** indicator stays lit even when you lower the **LEVEL** knob, lower the output level on the signal source connected to the input.*

- While pressing and holding the Record (●) button, press the Play (▶) button.
The Record (●) button indicator lights red when recording starts, and the **TRACK REC** indicators stop blinking and stay lit.
- Press the Stop (■) button to end recording.
- Use ◀◀ [RTZ] button, for example, to locate to a point that you want to check.

TIP

Use the RTZ and LRP Functions to easily locate to the beginning of the song (00h00m00s00f) or the last point where recording started. For more information about searching backward/forward and locating, see “Locate and search functions” on page 64.

- Press the Play (▶) button to play the recorded track.
Use the track **LEVEL** knob and the **MASTER LEVEL** knob to adjust the playback level.
Use the **TRACK 1/2 PAN** knobs and **TRACK 3/4 PAN (BAL)** knobs to set the left and right stereo position (or balance) of each track.
Use the **VOLUME** dial on the left side of the unit or the volume control of the external monitoring system (powered monitor speakers or an amplifier and speakers) to set the final monitoring volume.

NOTE

- The **TRACK 1/2 PAN** knobs, the **TRACK 3/4 PAN [BAL]** knobs and the track **LEVEL** knobs control the playback output signal levels and stereo positions of recorded tracks.*
- If you are not satisfied with the recorded sound, follow the procedures above again from the beginning.*

Multitrack recording

You can record new audio to different tracks while playing back already recorded tracks.

Setting the recording tracks

- Press the **TRACK REC** buttons of already recorded tracks so that their **REC** indicators become unlit.
- Press the **TRACK REC** buttons of tracks to be recorded to put them into recording standby (**REC** indicators blink).

Setting TRACK PAN/BAL and LEVEL values

Use the **LEVEL** knobs and **TRACK 1/2 PAN** knobs and **TRACK 3/4 PAN (BAL)** knobs to adjust their level and stereo positions for monitoring during overdubbing.

NOTE

*When the track type of track 3 or 4 is set to STEREO, that track's **PAN (BAL)** knob functions as a balance knob.*

Input selection and assignment

Use the procedures described earlier in this chapter to assign input sources to tracks for recording.

6 – Basic Recording

Setting input levels

Just as though you were recording, you can monitor the sound of already recorded tracks playing back and the input sources of the tracks for recording, allowing you to check the monitoring balance and volume.

Recording additional tracks

While pressing and holding the Record (●) button, press the Play (▶) button.

While listening to the playback tracks, make new recordings on other tracks.

Undoing operations (undo)

This unit allows you to undo, for example, unwanted operations and recordings that were unsuccessful. Undo can be used on many ordinary operations, including editing and recording operations. This unit has two types of undo functions. Single undo can be used with a simple button press, while multi-undo allows you to return to and undo a specific past operation.

NOTE

The UN/REDO indicator lights when a single undo or multi-undo has been conducted and there is an undone operation that can be redone.

Undoing the last operation (single undo)

Press the **UN/REDO** button to return to the state before the last operation was conducted. After doing this, the **UN/REDO** indicator lights, showing that redo (see below) is possible.

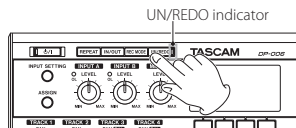

■ Cancelling an undo operation (redo)

Press the **UN/REDO** button when it is lit to return to the state of the last operation. The **UN/REDO** indicator turns OFF.

NOTE

If single undo is used when multi-undo (described below) has already been used to return the unit to a previous state, it will go one more step backward. If you press the UN/REDO button again to redo the step, the single undo operation is cancelled, and the previous multi-undo state is restored. In this case, the unit is not restored to the most recently conducted operation, so the UN/REDO indicator remains lit because further redo operations are possible.

Undoing a previous operation (multi-undo)

1. Press the **UN/REDO** button while pressing and holding the Stop (■) button to open the **HISTORY** screen.

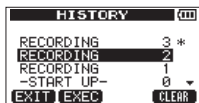

The **HISTORY** screen shows the operation history as a list.

Each operation in the list is called an “event”.

The event list starts at the bottom with event number 0 (–START UP–).

The most recent event has an asterisk (*) to its right.

All events that occurred after a selected event can be undone at once.

This operation is called “multi-undo” because it allows you to undo multiple events and return to an earlier state.

2. Use the **DATA** wheel to select the event that you want to return to (all events after the selected event will be undone).
3. Press the **F2** (**EXEC**) button to execute the multi-undo and restore the state just after the selected event was conducted.

In this state, the **UN/REDO** indicator lights.

The unit has been returned to a previous state, but the event information undone through the above operation is not erased. On the **HISTORY** screen, a * appears to the right of current event after undoing.

If you make a new recording or new edits after using multi-undo (**UN/REDO** indicator lit), the event history after the current event is cleared and the last operation conducted becomes the most recent event.

NOTE

When the **HISTORY** screen is open, the **UN/REDO** button does not function, so single undo and redo cannot be used.

CAUTION

- When undo has been used and there are one or more undone operations, the **UN/REDO** indicator lights.

The **UN/REDO** indicator does not light if there are no undone operations (the current state is that of the last operation).

When the **UN/REDO** indicator is lit (because there are undone operations), if you make a new recording or edit, the last operation conducted becomes the most recent event, and you will no longer be able to redo previously undone operations.

- When saving a song, a maximum of 500 items can be saved in the operation history as song files. If the operation history exceeds 500 items, the oldest events in the history are erased when the song is saved. Erased events cannot be restored.
- When the power is turned OFF (in standby) the operation history is completely erased. The operation history is not restored when the power is turned ON again.

6 – Basic Recording

Erasing the operation history

When the power is turned OFF (in standby), the operation history of the currently loaded song is erased (cleared). The operation history is not restored, so past operations cannot be undone or redone when the power is turned ON again.

You can also erase the operation history of the currently loaded song without turning the power OFF by using the following procedures.

NOTE

Turning the power OFF (putting it in standby) does not erase the operation history of songs that are not loaded.

1. While pressing and holding the Stop (■) button, press the UN/REDO button to open the HISTORY screen.

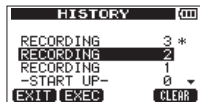

2. Press the F4 [CLEAR] button.
A confirmation pop-up message appears.



3. Press the F3 [YES] button.
Another confirmation pop-up message appears.



4. Press the F3 [YES] button to erase the operation history and delete unused data.

The Home Screen reopens when this operation completes.

NOTE

To cancel erasing the operation history, press the F4 [NO] button.

TIP

- If you open the HISTORY screen immediately after erasing the operation history, the event (operation) that appears is 0 (-START UP-), showing that the operation history has been cleared.
- If you want to keep the operation history even when you power OFF (in standby), turn song protect ON before turning the power OFF (in standby). (See "Protecting songs" on page 50.)

CAUTION

You cannot undo erasing the operation history! Only do it if you are certain about it.

7 – Recorder Functions

Punching in and out

Punching in/out is a technique to replace a part of an already recorded track. Start playback and when you reach the part that you want to replace, switch to record (punch in), then switch back to the Play (or stop) when you finish the part that you want to replace (punch out).

1. Decide what part of the track you plan to replace and choose a point to begin where the new recording can sit well with the existing recording.
2. Press the **REC** button of the TRACK that you plan to replace part of to start record standby (**REC** indicator blinks).
3. Start playback before the part of the track that you want to replace.
4. Press the Record (●) button to start recording (punch in) when you reach the part. Play or sing what you want to record.
5. Press the Play (▶) button to switch to playback (punch out) when you finish the replacement recording.

TIP

You can also press the Stop (■) button to punch out at the end of the replacement recording.

Bouncing tracks

Use this unit's bounce function to mix already recorded tracks (1–4) down to one or two tracks.

Multitrack tape recorders can only bounce to an open track (in other words, they can not record to a track that is also a source of the mix). For example, tracks 1–3 could be bounced to track 4, but tracks 1–4 could not be bounced to track 1. This unit, however, does not have this limitation.

You can mix down tracks 1–4 as a stereo mix to tracks 1 and 2 (stereo bounce), or bounce tracks 1–4 as a mono mix to track 1 (mono bounce).

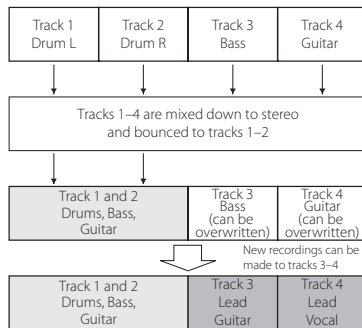

Source tracks are erased when they are bounce destinations. (In the illustration above the drum parts are overwritten by the stereo mix). However, you can use the unit's (undo) function to return to the previous state if you make a mistake. (See "Undoing operations (undo)" on page 58.)

NOTE

Inside this unit, a mixdown is made to create a stereo master track that is recorded to the designated tracks.

7 – Recorder Functions

Using the bounce function

1. When the recorder is stopped, press the **REC MODE** button to open the **RECORDER MODE** screen.

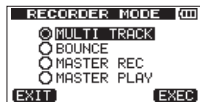

2. Use the **DATA** wheel to select (highlight) the **BOUNCE** item.

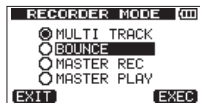

3. Press the **F4 [EXEC]** button.
After a **Bounce!** pop-up message appears, the recorder enters **BOUNCE** mode, and the Home Screen reopens.



NOTE

When the recorder is in **BOUNCE** mode, **BOUNCE** appears highlighted at the upper left of the Home Screen.

4. Press the **TRACK REC** buttons for the bounce destination tracks to light their indicators.

For a stereo bounce, press two mono track **REC** buttons or one stereo track **REC** button. (See "Setting the track type (Tracks 3 and 4 only)" on page 54.)

Examples: Press the **TRACK 1** and **TRACK 2 REC** buttons.
If the track type of **TRACK 3** and **TRACK 4** is set to **MONO**, press the **TRACK 3** and **TRACK 4 REC** buttons.
If the track type of **TRACK 3** or **TRACK 4** is set to **STEREO**, press either the **TRACK 3** or **TRACK 4 REC** button.

For a mono bounce (to a single track), press one mono track **REC** button

Examples: Press either the **TRACK 1** or **TRACK 2 REC** button.
If the track type of **TRACK 3** and **TRACK 4** is set to **MONO**, press either the **TRACK 3** or **TRACK 4 REC** button.

NOTE

When the bounce destination track is mono, **IN A (INPUT A)** is recorded regardless of the assignment settings.

TIP

You can record an additional performance to the bounce destination track(s) while monitoring the mix that is being bounced to them. In other words, you can overdub as you bounce.

5. Adjust the **LEVEL** and **TRACK 1/2 PAN** knobs and **TRACK 3/4 PAN (BAL)** knobs for the bounce source tracks.

For a stereo bounce, adjust the bounce source tracks according to their types as follows to maintain left and right channel separation.

Bounce source	How to adjust
TRACK 1 and TRACK 2	Turn the TRACK 1 PAN knob all the way to the left (L) and the TRACK 2 PAN knob all the way to the right (R).
TRACK 3 and TRACK 4 with track type set to MONO	Turn the TRACK 3 PAN (BAL) knob all the way to the left (L) and the TRACK 4 PAN (BAL) knob all the way to the right (R).
TRACK 3 or TRACK 4 with track type set to STEREO	Set the TRACK 3 or TRACK 4 PAN (BAL) knob to the center.

If a bounce source track type is set to **MONO**, set the **TRACK 1/3 PAN (PAN (BAL))** knob all the way to the left (L) and the **TRACK 2/4 PAN (PAN (BAL))** knob all the way to the right (R).

Use the **MASTER LEVEL** knob to adjust the overall level.

NOTE

*A mono bounce is not possible if a bounce source track type is set to **STEREO**. A stereo track cannot be converted to left and right mono tracks to create a mono bounce.*

6. After locating to the point where the bounce will start, while pressing and holding the Record (●) button, press the Play (▶) button, press the Play (▶) button to bounce the track.

Press the Stop (■) button at the point where you want to stop the bounce.

Confirming the result

Raise the bounce destination **TRACK LEVEL** knob (turn other **TRACK LEVEL** knobs all the way down) and the **MASTER LEVEL** knob, and start playback from the beginning of the song. If you are not satisfied with the result because, for example, the balance between instruments is poor, or the pan settings are wrong, use the undo function. (See “Undoing operations (undo)” on page 58.)

If you are satisfied with the result, when the recorder is stopped press the **REC MODE** button to open the **RECORDER MODE** screen and select **MULTI TRACK**.

After bouncing tracks, you can record again on (overwrite) tracks other than the bounce tracks.

TIP

If it is possible that you might need the original tracks at some later time, back-up the track data to a computer or copy the song before bouncing (See “Copying songs” on page 48.) (See “Connecting with a computer” on page 84.)

7 – Recorder Functions

Locate and search functions

Direct locate function

The current recorder position is shown at the top of the Home Screen in “hours: minutes: seconds: frames” (30 frames per second).

You can move the current recorder position to a specific time by inputting it here.

1. On the Home Screen, use the **HOME** button to move the cursor (underline) between time counter divisions.

You can edit the value at the cursor positions.

The seconds are selected in the following figure.



2. Use the **DATA** wheel to change the value above the cursor (underlined). When adjusting a value, it will carry over automatically when it reaches the highest or lowest value in a field. For example, when using the **DATA** wheel to increase the seconds value, if the number changes from 59 to 0, the minutes value will increase by one.

NOTE

When the **DATA** wheel is being turned, the following pop-up message appears.



3. Press the **HOME** button to move to a different time division and use the **DATA** wheel to change the value.
4. After setting the desired time value, press the Play (▶) button to start playback from that position.

Returning to the song beginning (RTZ function) or the point where recording was last started (LRP function)

Use simple button operations to return to the beginning of a song (00:00:00:00) or to locate to the position where recording last started.

RTZ is short for “Return To Zero,” and LRP is short for “Last Recording Position.”

Return To Zero (song beginning at 00:00:00:00)

Press the ◀◀ [RTZ] button while pressing and holding the Stop (■) button.

Last Recording Position (the position recording last started)

Press the [LRP] button while pressing and holding the Stop (■) button.

This function is useful when you want to record the same passage again.

Search backward/forward

When stopped, press the ◀◀ [RTZ] button/▶▶ [LRP] button to search backward/forward.

Each time you press one of these keys, the speed increases from 10x to 50x, 100x and 1000x.

During playback, press and hold the ◀◀ [RTZ] button/▶▶ [LRP] button to search backward/forward. During playback, the search backward/forward speed is fixed at 10x.

Repeat playback

Use the repeat playback function to play the same part again and again. The repeated passage is time between the IN and OUT points.

Setting IN and OUT points

In addition to using them for setting the repeat playback passage, the IN and OUT points are also used for interval setting for track editing. Moreover, the IN and OUT points are used as the start and end points when making stereo master tracks.

You can set these points when recording, playing back and stopped.

NOTE

In the following cases, IN and OUT points cannot be captured or edited.

- During repeat playback
- When the recording mode is set to MASTER REC or MASTER PLAY

■ Capturing IN and OUT points

1. Press the **IN/OUT** button to open the I/O SETTING screen.



2. Press the **F3 [IN]** button or **F4 [OUT]** button at the desired position (whether the unit is stopped, playing or recording) to set the IN/OUT point. SET IN! or SET OUT! and the captured time appear in a pop-up message.



SET IN



SET OUT

NOTE

When the Home Screen is open, you can also use the **F3** and **F4** buttons to set IN and OUT points even though these **F3/F4** button assignments do not appear.

The set times will be shown with a SET IN! or SET OUT! message as above.

■ Editing IN/OUT points

1. When the I/O SETTING screen is open, press the **F2 [EDIT]** button to enable editing.



2. Edit the values of IN and OUT points using the following guidelines.
 - Use the **F3 [▲]** and **F4 [▼]** buttons to move the cursor (underlined) between the IN and OUT items.
 - Use the **◀◀ [RTZ]** and **[LRP]** buttons to move the cursor (underlined) between time fields.
 - Use the **DATA** wheel to change the value at the cursor position (underlined).

7 – Recorder Functions

- When finished editing, press the **HOME** button to return to the Home Screen.

Using repeat playback

- Set the starting (IN) and ending (OUT) points for the time that you want to repeat, and then return to the Home Screen.
- Press the **REPEAT** button to start repeat playback.

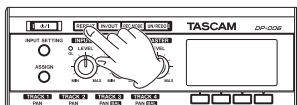

The  icon appears on the Home Screen during repeat playback.

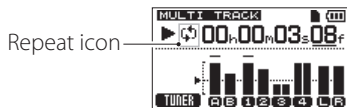

Playback starts from the IN point. When the OUT point is reached, after the set repeat interval elapses, playback starts again from the IN point. Playback continues to repeat between the IN and OUT points.

- Press the **REPEAT** button again to stop repeat playback. The  icon on the Home Screen disappears. The next section explains how to set the repeat interval that determines the amount of time until playback starts again after the OUT point is reached.

NOTE

If the time between the IN and OUT points is less than 2 frames, an  Too Short pop-up message appears when you press the REPEAT button and repeat playback will not occur.

Setting the time between repetitions (repeat interval)

The time between repetitions (repeat interval) can be set from 0.5 to 9.9 seconds.

- Press the **MENU** button to open the MENU screen.
- Use the **DATA** wheel to select (highlight) the PREFERENCE menu item, and press the **F4** [▶] button to open the PREFERENCE screen.



- Use the **F3** [▲] and **F4** [▼] buttons to select (highlight) the Repeat Int item setting value, and use the **DATA** wheel to set the value between 0.5sec (default value) and 9.9sec (in 0.1-second increments). Use the **F3** [▲] and **F4** [▼] buttons to select (highlight) the Repeat Int item setting value, and use the **DATA** wheel to set the value between 0.5sec and 9.9sec (in 0.1-second increments).
- After making the setting, press the **HOME** button to return to the Home Screen.

Editing on a conventional tape recorder in the past required advanced techniques, but with this unit editing tracks is easy and accurate. Moreover, with a tape recorder, an editing error could not be undone, but this unit uses nondestructive editing, allowing you to edit without altering the original data. This means that the undo function can be used to correct an edit easily. (See “Undoing operations (undo)” on page 58.)

Overview of track editing

This unit has the following track editing functions.

- CLONE TRACK (duplicate a track)
- CLEAN OUT (erase a track)
- SILENCE (erase part of a track)
- CUT (remove part of a track)
- OPEN (insert a silent section)

Editing points

Among track editing functions, SILENCE, CUT and OPEN use the IN and OUT points for editing. These are the same as the IN and OUT points used for repeat playback.

For instructions about how to set IN and OUT points, see “Setting IN and OUT points” on page 65.

Use the I/O SETTING screen to edit IN and OUT points. (See “Setting IN and OUT points” on page 65.)

IN point

The IN point is the beginning of the part of the track that will be edited. Press the **IN/OUT** button to open the I/O SETTING screen, and press the **F3 [IN]** button at the time where you want to set the IN point.

OUT point

The OUT point is the end of the part of the track that will be edited. Press the **IN/OUT** button to open the I/O SETTING screen, and press the **F4 [OUT]** button at the time where you want to set the OUT point.

Basic editing procedures

1. When the recorder is stopped, press the **MENU** button to open the MENU screen.
2. Use the **DATA** wheel to select (highlight) the **TRACK EDIT** item, and press the **F4 [▶]** button to open the **TRACK EDIT** screen.



8 – Editing Tracks

3. Use the **DATA** wheel to select (highlight) the desired track editing function, and press the **F4** [▶] button to open that editing function's screen.



4. Select the setting item value.

When there are multiple setting items, use the **F3** [▲] and **F4** [▼] buttons to select the items, and use the **DATA** wheel to set the values. For details about the settings, see the explanations of the functions on the following pages.

5. Press the **F2** [EXEC] button to execute the function.

NOTE

Press the **F1** [BACK] button to return to the TRACK EDIT screen.

Track editing function setting items

In this section, we explain the setting items that appear on the various track editing function screens.

SOURCE TRK (copy source track)

CLEAN OUT TRK (track to be deleted)

SILENCE TRK (track partially silenced)

CUT TRK (track partially deleted)

OPEN TRK (track to have silence inserted)

These items are used to select the tracks to be edited.

The options depend on the editing function.

- 1, 2, 3, 4: Individual tracks
- 1/2: Track pair
- 3/4: Tracks 3 and 4 selected
- 1-4: All tracks
- MST: Stereo master track
- ALL: Tracks 1-4 and stereo master track

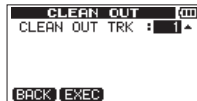
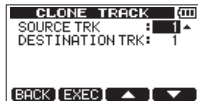

Example of SOURCE TRK item Example of CLEAN OUT TRK item

IN/OUT

These show the starting/ending points when it is necessary to define a part of a recording for editing.

However, you cannot change the IN and OUT points when using a track editing function. Set these points on the I/O SETTING screen, which you can open by pressing the **IN/OUT** button. (“Setting IN and OUT points” on page 65.)

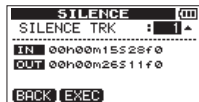

Example of IN and OUT items

DESTINATION TRK (copy destination track)

Use this to set the track that will be the destination of a copy, insert or clone edit.

If a mono track was set as the **SOURCE TRK**, the **DESTINATION TRK** item options will also be mono tracks.

If a stereo track was set as the **SOURCE TRK**, the **DESTINATION TRK** item options will be stereo tracks and 1/2 (track pair).

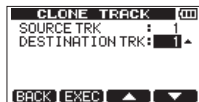

Example of DESTINATION TRK item

CLONE TRACK (track duplication)

Using **CLONE TRACK** you can create a copy of a single track, a track pair or a master track on a different track (or tracks).

This copies the entire track, so the IN and OUT points have no effect.

The parameters that can be set are as follows.

- SOURCE TRK (1, 2, 3, 4, 1/2, MST)
- DESTINATION TRK

NOTE

*If you choose the same track for both the **SOURCE TRK** item and the **DESTINATION TRK** item and press the **F2 [EXEC]** button, a Same Track pop-up message appears and the operation is cancelled.*

8 – Editing Tracks

CLEAN OUT (track erase)

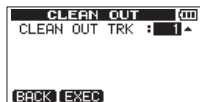

This completely erases the selected track. This erases the entire track, so the IN and OUT points have no effect.

The parameters that can be set are as follows.

- CLEAN OUT TRK (1, 2, 3, 4, 1/2, 3/4, 1-4)

SILENCE (part erase)

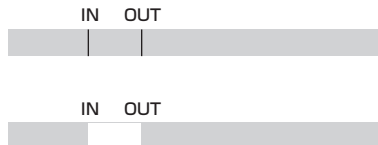

This erases the selected track between the IN and OUT points. This has the same effect as recording a silent signal between the IN and OUT points. This operation does not change the track length.

The parameters that can be set are as follows.

- SILENCE TRK (1, 2, 3, 4, 1/2, 3/4, 1-4)

TIP

This function can be used to remove short noises, for example.

CUT (remove part)

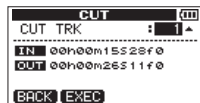
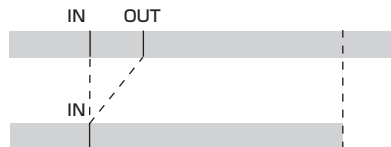

The part of the track between the IN and OUT points on the selected track is CUT (deleted), and the rest of the track after the OUT point is moved forward to the IN point. As a result, the length of the track becomes shorter.

The parameters that can be set are as follows.

- CUT TRK (1, 2, 3, 4, 1/2, 3/4, 1-4, ALL)

OPEN (insert silence)

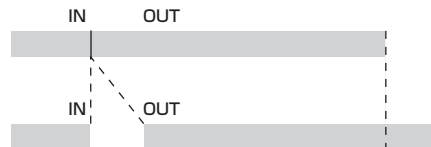

A silent passage is inserted between the IN and OUT points on the selected track. This operation splits a track at the IN point and the beginning of the part after the IN point is shifted to the OUT point. As a result, the length of the track becomes longer.

The parameters that can be set are as follows.

- OPEN TRK (1, 2, 3, 4, 1/2, 3/4, 1-4, ALL)

9 – Mixdown and mastering

Mixdown

Adjusting the volumes and stereo positions of the recorded tracks to create a well-balance stereo mix is called mixdown.

Level and balance

Use the **TRACK 1–4 LEVEL** knobs to adjust the relative balance between tracks. Then, use the **MASTER LEVEL** knob to adjust the overall level.

Watching the **L** and **R** level meters on the display, adjust the levels until they are suitable. If the volume is too loud, the sound will be distorted.

NOTE

*The track level meters on the display show the recorded signal levels on the tracks. Therefore, these meters do not change even when the **TRACK LEVEL** knobs are adjusted.*

TIP

You do not need to keep the entire song at the same volume. For example, you could gradually increase the volume during a guitar solo.

Stereo position (panning)

Use the **PAN** knob of **TRACK 1** or **2** to adjust the left-right stereo position of the track.

If **TRACK 3** or **TRACK 4** is a stereo track, use its **PAN (BAL)** knob to adjust the balance of its left and right channels.

If **TRACK 3** or **TRACK 4** is a mono track, use its **PAN (BAL)** knob to adjust the left-right stereo position of the track as with **TRACK 1** and **2**.

Creating stereo master tracks

When you are satisfied with the mix of your tracks, you can mix them down to a stereo master track.

A stereo master recorded by this unit is saved as part of the song, and can be recorded by an external stereo recorder. It can also be converted by the unit into a WAV file and exported to a computer where the sound can be processed further or combined with other recordings. (See “Exporting stereo master tracks” on page 92.)

NOTE

Only one stereo master can be made in a song at a time.

Setting the starting and ending points

Before you start creating a stereo master track, you must set the starting and ending points. The part of the song between the IN and OUT points will be recorded as the stereo master track. Ordinarily, the beginning of the song is set as the IN point and the end of the song is set as the OUT point.

Press the **F3 [IN]** button at the point where you want to start the stereo master track to set the IN (starting) point and press the **F4 [OUT]** button at the point where you want to end it to set the OUT (ending) point.

For details about adjusting IN and OUT points, see “Setting IN and OUT points” on page 65.

Creating a stereo master track

After setting the IN and OUT points, you can make the stereo master track.

1. When the recorder is stopped, press the **REC MODE** button to open the **RECORDER MODE** screen.



- Use the DATA wheel to select (highlight) the **MASTER REC** item.

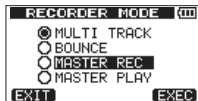

- Press the **F4 [EXEC]** button.

After a **Master Rec!** pop-up message appears, the recorder switches to master recording mode and the Home Screen reopens.

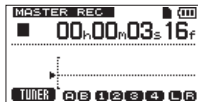

At this point, if you start playback or recording, you will be able to hear the mixed track signals (including signals that will be recorded) through headphones or an external monitoring system (powered monitor speakers or an amplifier and speakers).

NOTE

- When in master recording mode, **MASTER REC** appears highlighted at the top left of the Home Screen.
- If you try to switch to master recording mode when the length of the interval between **IN** and **OUT** points is less than four seconds, a **Trk Too Short** (track is too short) pop-up message appears and master recording mode will not be activated.
- You cannot change the **IN** and **OUT** points when in master recording mode.
- Playback and some other functions do not work when the unit is in master recording mode. If you try to use one of these functions, an **In Master Mode** pop-up message appears.

- While pressing and holding the Record (●) button, press the Play (▶) button to start creating a stereo master track. The Record (●) indicator lights.

Regardless of the recorder position, the part of the song between the **IN** and **OUT** points will be recorded as the stereo master track.

As necessary, use the **LEVEL** and **TRACK 1/2 PAN** and **TRACK 3/4 PAN (BAL)** knobs to adjust the mix. These adjustments will affect the recorded stereo master track.

Creating a stereo master track automatically ends when the recorder reaches the **OUT** point.

- If you want to redo creation of the stereo master track, press the Play (▶) button again while pressing and holding the Record (●) button. This will create a new stereo master track, overwriting and deleting the previous one.

NOTE

- After recording a stereo master track, you can play it back to check it. (See “Checking stereo master tracks” on page 74.)
 - You can undo the creation of a stereo master track. So, after re-recording the stereo master track several times, you can go back and choose one that was previously recorded.
- Press the **REC MODE** button to open the **RECORDER MODE** screen, and use the DATA wheel to return the recorder to **MULTI TRACK** mode.

9 – Mixdown and mastering

Checking stereo master tracks

After creating a stereo master track, you can listen to it by following these procedures.

1. When the recorder is stopped, press the **REC MODE** button to open the **RECORDER MODE** screen.

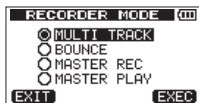

2. Use the **DATA** wheel to select (highlight) the **MASTER PLAY** item.

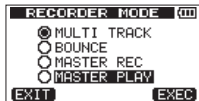

3. Press the **F4 [EXEC]** button.

After a **Master Play!** pop-up message appears, the recorder switches to **MASTER PLAY** mode, and the Home Screen reopens.



NOTE

- When the recorder is in **MASTER PLAY** mode, **MASTER PLAY** appears highlighted at the top left of the Home Screen.
- If there is no stereo master track, a **No Master Trk pop-up message** will appear and the recorder mode will not change to **MASTER PLAY**.

4. In this mode, press the Play (▶) button to play the stereo master track. The stereo master track signal is output from the Ω / **LINE OUT** jack, so it can also be dubbed to an external stereo recorder.
5. After you have created a stereo master track that you are satisfied with, press the **REC MODE** button to open the **RECORDER MODE** screen, and use the **DATA** wheel to return the recorder to **MULTI TRACK** mode.

If you are not satisfied with the stereo master track, you can create a new one. A new stereo master track will overwrite the previous one.

NOTE

To listen to the recorded stereo master track of a saved song, load that song, set the recorder mode to **MASTER PLAY** and then press the Play (▶) button to start playback.

TIP

- When creating a stereo master track, you can play along with the mixdown signal and record that sound through **INPUT A/B** to mix it with prerecorded tracks.
- When this recorder is in **MULTI TRACK** mode, you can transfer a stereo master mix created on this unit as a file that can be played back on a computer. (See “Exporting stereo master tracks” on page 92.)
- When this recorder is in **MULTI TRACK** mode, you can copy a stereo master track to **TRACK 1** and **TRACK 2** or stereo **TRACK 3** or **TRACK 4** by cloning the track. (See “CLONE TRACK (track duplication)” on page 69.)

10 – Miscellaneous Functions

Metronome

This unit has a built-in metronome function that can be used when the recorder is operating. You can set it to function during both playback and recording or only during recording.

1. When the recorder is stopped, press the **MENU** button to open the MENU screen.
2. Use the **DATA** wheel to select (highlight) the **METRONOME** item, and press the **F4 [▶]** button to open the **METRONOME** screen.

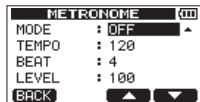

3. Set the following items.
Use the **F3 [▲]** and **F4 [▼]** buttons to select (highlight) items, and use the **DATA** wheel to set their values.

MODE

Select one of the following modes.

Mode	Meaning
OFF (default value)	metronome OFF, default value
REC&PLAY	Metronome functions during both recording and playback
REC ONLY	Metronome functions only during recording

TEMPO

Set the speed between 20 and 250 BPM (default value: 120).

BEAT

Set the number of beats between 1 and 12 (default value: 4).
The accent falls on the first beat.

LEVEL

4. After completing the setting, press the **HOME** button to return to the Home Screen.
The metronome will now function according to the MODE setting made in step three.
Even if the metronome is active during recording, the its sound will not be recorded directly.

NOTE

- *If you record using a mic while monitoring the metronome sound through connected speakers, the metronome sound could be recorded.*
- *When the metronome is operating, you can adjust the LEVEL item, but other items on the METRONOME screen cannot be changed.*
- *You can use the metronome to provide a click when making the first recording of, for example, a rhythm guitar or bass part.*
- *If you want to use the metronome when practicing, you can either play a song that does not have any recordings or turn the TRACK LEVEL knobs all the way down during playback.*

10 – Miscellaneous Functions

Tuner

Use the built-in chromatic tuner to tune guitars or wind instruments, for example.

1. Connect a guitar or bass to **INPUT A**.
INPUT B cannot be used for tuning.
Use built-in MIC A to tune other instruments such as wind instruments.
2. On the **INPUT SETTING** screen, set the **IN A** input source to **GUITAR/ LINE**, **GUITAR/LINE M** or **GUITAR/LINE H**. (See “Selecting the input source” on page 51.)

NOTE

When using the built-in mic, select INT.MIC A-Low INT.MIC A-Mid or INT.MIC A-High on the INPUT SETTING screen.

3. Press the **HOME** button to show the Home Screen.
4. When the recorder is stopped, press the **F1 [TUNER]** button to open the **TUNER** screen.
The **Calibration** (standard frequency) item is selected (highlighted).

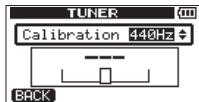

5. Use the **DATA** wheel to set the standard frequency of the A note between 435 and 445 Hz. (default value: “440Hz”)

6. Play the instrument and tune it.

The pitch name closest to the string appears above the meters. Tune the string roughly until the sound name that you want appears. Then, fine tune the string until the rectangle at the middle of the meter darkens, showing that the string is in tune. If the pitch is too low, a bar extends to the left of the middle and if it is too high it extends to the right. The longer the bar is the more out of tune the string is.

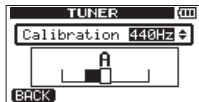

The rectangle at the middle of the meter darkens when the string is in tune.

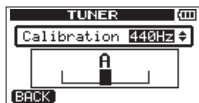

7. When you are finished tuning, press the **HOME** button to open the Home Screen.

NOTE

*If you want to monitor the input signal, press the **REC** button of the track that has **IN A (INPUT A)** assigned to it. (See “Assigning inputs” on page 54.)*

Automatic power saving function

You can set the amount of time until the unit automatically turns OFF (enters standby) after its last activity or operation.

1. When the recorder is stopped, press the **MENU** button to open the MENU screen.
2. Use the **DATA** wheel to select (highlight) the PREFERENCE item and press the **F4 [▶]** button to open the PREFERENCE screen.
3. Use the **F3 [▲]** and **F4 [▼]** buttons to select (highlight) the Auto Pwr Save item setting value, and use the **DATA** wheel to set it to one of the following values.

Options: OFF (does not turn off automatically), 3min, 5min, 10min, 30min (default value)

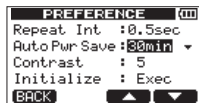

4. After completing the setting, press the **HOME** button to return to the Home Screen.

Restoring preferences to default values

You can restore PREFERENCE screen settings and backup memory items (See page 100.) to their initial values (values set when the unit was shipped from the factory). This operation is called initialization.

1. When the recorder is stopped, press the **MENU** button to open the MENU screen.
2. Use the **DATA** wheel to select (highlight) the PREFERENCE item and press the **F4 [▶]** button to open the PREFERENCE screen.
3. Use the **F3 [▲]** and **F4 [▼]** buttons to select (highlight) Exec next to Initialize, and press the **F2 [EXEC]** button.



4. When a confirmation pop-up message appears, press the **F3 [YES]** button.

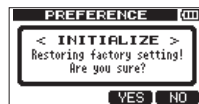

After initialization completes, the PREFERENCE screen reopens.

NOTE

Press the **F4 [NO]** button to cancel initialization.

5. After completing initialization, press the **HOME** button to return to the Home Screen.

10 – Miscellaneous Functions

Viewing information

You can view information about the current song (currently loaded song), the SD card, the system and the firmware.

1. When the recorder is stopped, press the **MENU** button to open the MENU screen.
2. Use the **DATA** wheel to select (highlight) the **INFORMATION** item, and press the **F4** [▶] button to open the **SONG (1/4)** page of the **INFORMATION** screen.

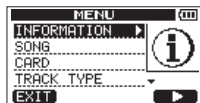

The **INFORMATION** screen has four pages including this one.

3. Use the **F3** [PREV] and **F4** [NEXT] buttons to change the page.

The pages contain the following information.

SONG (1/4) page

For the MTR partition that holds the currently loaded song, the partition number, the name (title) of that song and the remaining recording time are shown



CARD (2/4) page

MTR partitions and capacities, FAT partition capacity

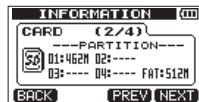

SYSTEM (3/4) page

Repeat playback interval, automatic power saving time and contrast settings



F/W (4/4) page

system firmware version



11 – SD Card Management

Overview of partitions

As described in “Partitions and songs” (page 45), SD cards formatted by this unit are divided into partitions. MTR partitions are for recording data while the FAT partition can be accessed with a personal computer. High-capacity cards can have multiple MTR partitions. In this case, you can use the MTR partitions for different songs, for example, or copy songs to a different MTR partitions to save their information. The FAT partition is FAT32 format and can be accessed by a computer connected to this unit by USB. This FAT partition is used to save songs and export stereo masters to computers, as well as to allow this unit to import audio files into songs, for example. For this reason, two steps are necessary to copy from a MTR partition and a computer. You can also format an entire card or individual partition as well as change the divisions between partitions (repartition) as necessary.

CAUTION

Formatting and repartition operations cannot be undone!

NOTE

- The FAT (File Allocation Table) format is a disk format that can be read by a computer.
- SD cards that meet SD/SDHC standards and are at least 512 MB can be used with this unit. A list of SD cards that have been confirmed for use with this unit can be found on the TASCAM website (<http://tascam.com/>).
- See “Selecting the active partition” on page 45 for how to change the active partition.

Formatting SD cards

This operation formats the entire card and allows you set MTR partition sizes for high-capacity cards.

CAUTION

This operation erases all the data on the card and cannot be undone! Confirm that you will not lose important data before formatting a card.

1. When the recorder is stopped, press the **MENU** button to open the MENU screen.
2. Use the **DATA** wheel to select (highlight) the **CARD** item, and press the **F4 [▶]** button to open the **CARD** screen.
3. Use the **DATA** wheel to select the **FORMAT** item, and press the **F4 [▶]** button to open the **FORMAT** screen.

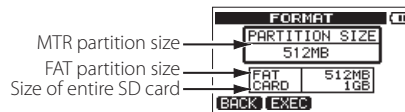

The following table shows the FAT and MTR partition sizes for different SD card capacities. The FAT partition size is set automatically according to card capacity. The size of the MTR partition on cards 4 GB or smaller is also fixed, but cards that are 8 GB or larger have multiple MTR partitions and their sizes can be chosen. However, the last MTR partition is set to fill the remaining space on the card automatically, so its size cannot be chosen.

11 – SD Card Management

SD card capacity and partition size

SD card capacity	FAT partition size	MTR partition size
32GB	4GB	2GB, 4GB, 8GB or 16GB
16GB	4GB	2GB, 4GB or 8GB
8GB	2GB	2GB or 4GB
4GB	2GB	2GB fixed
2GB	1GB	1GB fixed
1GB	512MB	512MB fixed
512MB	256MB	256MB fixed

NOTE

- The unit can handle a maximum of 4 MTR partitions, no matter how small you make them.
 - When you insert an unformatted SD card, the unit will ask you to format it. At this time, however, you cannot choose the size of the MTR partitions. If you want to change the sizes, follow the procedures above to format the card.
4. If the capacity of the SD card is 8 GB or less, press the **F2** [EXEC] button. If the capacity of the SD card is more than 8 GB, use the **DATA** wheel to set the size of the MTR partition, and press the **F2** [EXEC] button. A pop-up message warning that all songs will be erased appears.



5. Press the **F3** [YES] button to format the SD card. For example, if you format a 16 GB SD card with 4GB MTR partitions, 12 GB are left for MTR partitions after 4 GB is used for the FAT partition. Three partitions are created. Two are 4 GB and the last one is 3 GB. (Since 1GB is actually 1024 MB, the total size of the partitions does not always match the SD card size.)

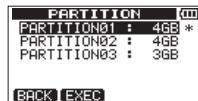

NOTE

- When formatting finishes the **CARD** menu screen reopens.
- After formatting, one song is automatically created in each MTR partition.
- To cancel formatting, press the **F4** [NO] button.

Reformatting MTR partitions

You can reformat any MTR partition if you want. Use this function when you just want to format a specific partition without changing its size.

CAUTION

You cannot undo this operation! All the data on the selected partition will be erased, so be certain that you will not lose anything important when reformatting.

1. When the recorder is stopped, press the **MENU** button to open the **MENU** screen.
2. Use the **DATA** wheel to select (highlight) the **CARD** item, and press the **F4 [▶]** button to open the **CARD** screen.
3. Use the **DATA** wheel to select (highlight) the **REFORMAT** item, and press the **F4 [▶]** button to open the **REFORMAT** screen.

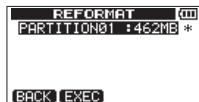

A list of the MTR partitions and their sizes (not open capacities) appear. The currently selected MTR partition has an asterisk (*) on its right.

4. Use the **DATA** wheel to select (highlight) the MTR partition that you want to reformat, and press the **F2 [EXEC]** button.

A pop-up message appears warning you that this will delete all the data on the MTR partition.

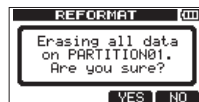

5. Press the **F3 [YES]** button to reformat the MTR partition.

NOTE

- *When reformatting finishes the **CARD** menu reopens.*
- *After reformatting, one song is automatically created in the MTR partition.*
- *To cancel reformatting, press the **F4 [NO]** button.*

11 – SD Card Management

Reformatting FAT partitions

You can also reformat just the FAT partition. The size of the FAT partition cannot be changed.

CAUTION

You cannot undo this operation! All data on the FAT partition will be erased, so be certain that you will not lose anything important when reformatting.

1. When the recorder is stopped, press the **MENU** button to open the MENU screen.
2. Use the **DATA** wheel to select (highlight) the **CARD** item, and press the **F4 [▶]** button to open the **CARD** screen.
3. Use the **DATA** wheel to select (highlight) the **FAT REFORMAT** item, and press the **F4 [▶]** button.

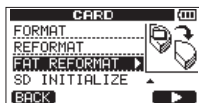

A pop-up message warning that all data on the FAT partition will be erased appears.



4. Press the **F3 [YES]** button to reformat the FAT partition.

NOTE

- When reformatting finishes the **CARD** menu screen reopens.
- To cancel reformatting, press the **F4 [NO]** button.

Initializing SD cards

If you want to use an SD card that was used with this unit, we recommend that you initialize it.

When you initialize an SD card, the entire card is formatted as FAT32.

1. When the recorder is stopped, press the **MENU** button to open the MENU screen.
2. Use the **DATA** wheel to select (highlight) the **CARD** item, and press the **F4 [▶]** button to open the **CARD** screen.
3. Use the **DATA** wheel to select (highlight) the **SD INITIALIZE** item, and press the **F4 [▶]** button.

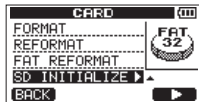

A pop-up message warning that all data on the card will be erased appears.



4. Press the **F3 [YES]** button to initialize the entire SD card and format it in FAT32 format.

NOTE

*To cancel initialization, press the **F4 [NO]** button.*

CAUTION

After initializing an SD card, it must be formatted again to be used with this unit. (See "Formatting SD cards" on page 79.)

12 – Exchanging Data with a Computer

By connecting this unit with a computer using the included USB cable you can backup song data on this unit's SD card to the computer and restore backed-up song data from the computer. Moreover, you can export track files and stereo master files from a song to a computer and import audio files on the computer to the unit.

Backed-up data can be restored to a different DP-006 unit than the one that created it. In this way, files can be freely exchanged between DP-006 units, making it easy to add additional recordings or mix existing recordings in a different location.

CAUTION

Instead of using the USB connection, if you want to remove an SD card from this unit and back-up its data by connecting it directly to a computer (or using a card reader), always turn the unit's power off (put in standby) before removing the card.

NOTE

- *The MTR partitions where song files are stored cannot be directly accessed from a computer.*
- *In this chapter, "computer" refers to a Windows or Macintosh computer connected to this unit. (See "Supported operating systems" on page 83.)*

The following types of data can be transferred from this unit to a computer.

■ Entire songs

You can transfer the data for an entire song from the unit's BACKUP directory on the FAT partition to a computer. This operation is called "backup." In addition, data backed-up on a computer can be transferred to the BACKUP directory on the FAT partition, and then restored as song data. This operation is called "restore."

■ WAV format tracks

You can convert tracks to WAV files and export them to a computer. You can also import WAV files from a computer.

These WAV files are stored on the WAVE directory of this unit's FAT partition.

■ Stereo master files

Stereo master files can be transferred as stereo WAV files from the WAVE directory on the FAT partition of this unit to a computer.

Only export is possible.

Supported operating systems

You can connect this unit to computers with the following operating systems.

■ Windows

Windows XP, Windows Vista, Windows 7

■ Mac OS X

Mac OS X 10.2 or later

When this unit is connected to a computer, the computer recognizes it as a removable disk. There is no need for a special driver.

NOTE

Data transfer between this unit and a computer occurs at USB 2.0 speed (maximum). Data can still be transferred if the computer connection is USB 1.1, but it will be slower. In addition, to assure USB 2.0 speed, use the included cable or a cable that meets USB 2.0 standards.

12 – Exchanging Data with a Computer

Connecting with a computer

To use the FAT partition of this unit, the unit must be connected to a computer by USB. When connected by USB, this unit's record, playback and other recorder operations cannot be used.

To connect with a computer, connect the USB port on the right side panel of the unit with a USB port on the computer using the included USB cable. It does not matter whether you turn the unit's power ON before or after the USB connection is made.

If the USB connection is made while the unit's power is ON, the currently loaded song is saved before the USB connection becomes effective.

If the USB connection is made while this unit's power is ON, the currently loaded song is saved before the USB connection becomes active and the following screen appears on the display.

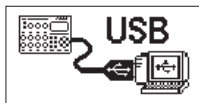

If you turn the unit's power ON after making the USB connection, the screen above appears right away.

The unit appears as an external drive named "DP-006" on the computer's display.

Click the "DP-006" drive on the computer to view the "BACKUP", "WAVE" and "UTILITY" folders in the FAT partition of the DP-006.

CAUTION

- *This unit receives power from batteries or a TASCAM PS-P520 AC adaptor. It cannot be powered over USB.*
- *Do not make a USB connection when the remaining battery level is low. If the power turns OFF during data transfer, all the data will be lost. This lost data cannot be restored.*
- *Do not change the names of the three folders in "DP-006".*
- *The total number of files and folders that this unit can recognize on a FAT partition is 100. If the number exceeds 100, transfer them to a computer hard drive, for example.*

NOTE

- *This unit can only be connected to a computer by USB when the recorder mode is set to MULTI TRACK.*
- *Before connecting the unit and the computer by USB, confirm that you have exported or backed up to the FAT partition all the files that you want to transfer to the computer.*
- *The "UTILITY" folder is used to update the unit's system software, for example.*

Disconnecting

Follow these steps to properly end the USB connection.

CAUTION

When transferring data, do not disconnect the unit or remove the USB cable. Doing so could cause data on the computer or this unit to be damaged.

NOTE

The procedure on the computer for disconnecting might be called “eject” or “unmount”.

Disconnecting from Windows XP/Windows Vista/Windows 7

Follow the procedures below to disconnect computers that use Windows XP, Windows Vista, or Windows 7 operating systems.

A PC card icon and arrow appear in the taskbar (usually at the bottom right of the screen).

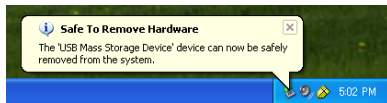

1. Left-click on this icon to open a pop-up bar. Click this pop-up bar to disconnect this unit from the computer.
2. After a pop-up message appears on the computer display saying that the unit can be disconnected, remove the USB cable.
The unit restarts automatically and the Home Screen opens on its display.

NOTE

Do not remove the USB cable if a pop-up message warning that the unit cannot be disconnected safely appears on the computer display. Close all the computer programs and windows that are accessing (reading or writing) files on the unit, and then try the operation again.

Disconnecting from Mac OS X

1. Drag the “DP-006” icon that represents this unit to the Trash, or type Command-E to disconnect the DP-006.
2. After the DP-006 icon disappears from the desktop, remove the USB cable.
This unit restarts and the Home Screen appears on the display.

TIP

Depending on the OS version or OS settings, you might also be able to disconnect the DP-006 by clicking an eject icon next to it in the Finder window or by using a control key.

12 – Exchanging Data with a Computer

Song backup and restoration

Song backup saves not only audio tracks, but also backs up editing data and other song data. Song restoration is the reverse of this process. In short, song files are transferred from the computer to the FAT partition of the unit and then used to restore the song.

Backing-up songs

Before starting a backup, check that the MTR partition that has the song that you want to backup is selected. (See “Selecting the active partition” on page 45.)

1. When the recorder is stopped, press the **MENU** button to open the MENU screen.
2. Use the **DATA** wheel to select (highlight) the **DATA BACKUP** item, and press the **F4 [▶]** button to open the **DATA BACKUP** screen.

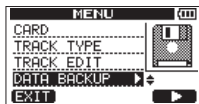

3. Use the **DATA** wheel to select (highlight) the **SONG BACKUP** item, and press the **F4 [▶]** button to open the **SONG BACKUP** screen.



A list of songs in the currently selected MTR partition appears.

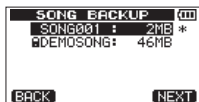

4. Use the **DATA** wheel to select (highlight) the song you want to back up, and press the **F4 [NEXT]** button.

A screen appears that allows you to edit the file name (title) of the song selected on the **SONG BACKUP** screen.



5. Edit the name (title) of the song being backed up as necessary. (See “Editing names” on page 46.)
6. After setting the name (title), press the **F2 [EXEC]** button.

A backup copy of the song on the active partition is made on the FAT partition (“001” is added as an extension).

A **Writing File** pop-up message appears on the display while backing up.



When the backup is complete, the **DATA BACKUP** screen reopens.

NOTE

*If the open space necessary to back up a song is not available on the FAT partition, a **It's too Large** (the file is larger than the available open space) pop-up message appears. In this case, connect this unit and a computer, and erase unnecessary files on the partition using the computer to make enough open space.*

12 – Exchanging Data with a Computer

7. Connect this unit to a computer using the USB cable. (See “Connecting with a computer” on page 84.)
8. Use the computer to copy backup files from the BACKUP directory on the FAT partition of the unit to the computer.
9. When done backing up, end the USB connection. (See “Disconnecting” on page 85.)

CAUTION

- *If you use a computer to change the name of a song file that has been backed up, use no more than eight ordinary English letters and numbers.*
- *Do not change the file extension.*

Restoring songs

Basically, restoring is the reverse of backing up. In short, transfer a backup file on a computer to this unit to restore a song.

1. Connect this unit to a computer using the USB cable. (See “Connecting with a computer” on page 84.)
2. Use the computer to copy backup files from the computer to the BACKUP directory on the FAT partition of the unit.
3. When done copying, remove the USB cable using the proper procedures and disconnect the unit from the computer. (See “Disconnecting” on page 85.)
4. After this unit restarts automatically, press the **MENU** button to open the MENU screen.
5. Use the **DATA** wheel to select (highlight) the **DATA BACKUP** item, and press the **F4** [**▶**] button to open the **DATA BACKUP** screen.



6. Use the **DATA** wheel to select (highlight) the **SONG RESTORE** item, and press the **F4** [**▶**] button to open the **SONG RESTORE** screen.



This screen shows the backup files on the FAT partition.



12 – Exchanging Data with a Computer

NOTE

A **File Not Found** (the file cannot be found) pop-up message appears if there are no files on the FAT partition.

- Use the **DATA** wheel to select (highlight) the file that you want to restore, and press the **F2** [EXEC] button.
The actual song name and an **Are you sure?** confirmation pop-up message appear.



NOTE

If the file name is short, spaces appear after the file name on the FAT partition, but those spaces are not included in the actual file name.

- Press the **F3** [YES] button.
After the currently loaded song is saved, the song selected in step 7 is restored and loaded.

NOTE

If there is not enough open space on the SD card, a **Card Full** pop-up message appears.

- Press the **HOME** button to reopen the Home Screen.

Track import and export

You can import and export individual tracks between a computer and this unit's FAT partition.

Files that can be imported/exported as tracks must be in the WAV format (with the ".WAV" extension).

You can import and export both mono and stereo files.

If you want to import an audio file that is of a different format, you must first convert it to a 16-bit, 44.1kHz mono/stereo WAV file.

Importing to tracks

Before importing a track, first select the partition with the song that you want to import it into as the active partition. Then, load the song that you want to import tracks into. (See "Selecting the active partition" on page 45.)

- Connect the unit to a computer using the included USB cable. (See "Connecting with a computer" on page 84.)
- Use the computer to copy WAV files on its drive to the WAVE directory in this unit's FAT partition.

NOTE

The files to be copied must have single-byte alphanumeric character names (8 characters or less). If you try to copy a file with double-byte characters, it cannot be imported because the file name will not appear on the display in step 6 below.

- After you have imported the track files from the computer, remove the USB cable using the proper procedures and disconnect the unit from the computer. (See "Disconnecting" on page 85.)
- After this unit restarts automatically, press the **MENU** button to open the MENU screen.

12 – Exchanging Data with a Computer

5. Use the **DATA** wheel to select (highlight) the **IMPORT/EXPORT** item, and press the **F4 [▶]** button to open the **IMPORT/EXPORT** screen.



IMPORT/EXPORT screen appears.

6. Use the **DATA** wheel to select (highlight) the **IMPORT TRACK** item, and press the **F4 [▶]** button.



Song files on the FAT partition are shown.



NOTE

- This unit does not support WAV files with sampling frequencies other than 44.1 kHz. Such files are not displayed even if they have been imported. If no files that can be imported are on the FAT partition, an **Import File Not Found** pop-up message appears.
- If the file name is short, spaces appear after the file name on the FAT partition, but those spaces are not included in the actual file name.

7. Use the **DATA** wheel to select the WAV file that you want to import, and press the **F2 [NEXT]** button.

The amount of open space on the MTR partition and the size of the selected WAV file appear on the display.

If the WAV file is stereo, this unit automatically selects two mono tracks (**TRACK 1** and **2**) or a stereo track (**TRACK 3** or **TRACK 4**).



8. Use the **DATA** wheel to select the track to which you want to import the WAV file, and press the **F4 [EXEC]** button to start importing.

NOTE

- If there is not enough open space, an **Import File Too Large (the file to be imported is too large) warning pop-up message** appears.
- The track that is the destination for the import must be empty. This unit reads the file from the FAT partition, and imports it to the designated track. The beginning of the file is set at the start of the song (00h00m00s00f). In the same way as other recording tracks, you can edit the track that has received the imported file. (See “8 – Editing Tracks” on page 67.)
- When importing stereo WAV files, it is necessary to have an open pair of tracks or a stereo track.

CAUTION

After importing a file to **TRACK 3** or **4**, if the track type has been changed from stereo to mono or mono to stereo, any file that has been imported to this track previously will be deleted. This operation can be undone.

9. When done importing, press the **HOME** button to return to the Home Screen.

12 – Exchanging Data with a Computer

Exporting tracks

You can export the tracks that you want as 16-bit, 44.1kHz mono and stereo WAV files.

1. When the recorder is stopped, press the **MENU** button to open the **MENU** screen.
2. Use the **DATA** wheel to select (highlight) the **IMPORT/EXPORT** item, and press the **F4 [▶]** button to open the **IMPORT/EXPORT** screen.



3. Use the **DATA** wheel to select (highlight) the **EXPORT TRACK** item, and press the **F4 [▶]** button to open the **EXPORT TRACK** screen.



On this screen, song tracks that have audio files are shown in a list.



You can tell the original track number by the file name.

TIP

Press the **F3 [NAME]** button to open the **NAME EDIT** screen where you can edit the file name. (See “Editing names” on page 46.)



NOTE

Song tracks that do not have audio files are not shown in the file list.

4. Use the **DATA** wheel to select (highlight) a track to export, and press the **F4 [✓]** button to put a ✓ in its checkbox.



By putting ✓ marks in multiple checkboxes, you can export multiple tracks at the same time.

NOTE

To remove a ✓ from a checkbox select (highlight) that track and press the **F4 [✓]** button.

12 – Exchanging Data with a Computer

5. When you finish selecting (putting a ✓ next to) the tracks that you want to export, press the **F2** [NEXT] button.

The amount of open space on the FAT partition (which is the destination for the exported tracks) and the total number of tracks to be exported is shown.



6. Press the **F4** [EXEC] button.

The selected track is exported to the FAT partition with the edited file name with the ".WAV" extension added as the track file name.

If you have previously exported a track file with the same name (title), a Duplicate name Are you sure? (A file with the same name already exists. Are you sure that you want to overwrite it?) confirmation pop-up message appears.



Press the **F3** [YES] button to overwrite the old file.

Press the **F4** [NO] button to cancel the export and return to the file list screen.

7. Press the **HOME** button to reopen the Home Screen.
8. Connect this unit to a computer. (See "Connecting with a computer" on page 84.)
9. Use the computer to copy track files from the WAVE folder on the FAT partition to the computer.

10. After exporting track files to the computer, remove the USB cable using the proper procedures and disconnect the unit from the computer. (See "Disconnecting" on page 85.)

NOTE

- You can change the name of an exported track file on the computer. If you do so, use no more than 8 English letters and numbers for the name and always follow them with the ".wav" extension. Furthermore, do not use special symbols, for example.
- Exported files are given names according to their source tracks in the following manner.

TRACK 1: "TEX001.WAV"

TRACK 2: "TEX002.WAV"

TRACK 3 (mono): "TEX003.WAV"

TRACK 3 (stereo): "TEX003S.WAV"

TRACK 4 (mono): "TEX004.WAV"

TRACK 4 (stereo): "TEX004S.WAV"

12 – Exchanging Data with a Computer

Exporting stereo master tracks

When you create a new stereo master track for a song, the existing stereo master track is overwritten, so if you want to keep multiple different stereo master tracks, you should save them to a computer.

Before starting the following export procedures, make sure that the song for which you want to export a stereo master track is currently loaded and that you have already created a stereo master track for it.

1. When the recorder is stopped, press the **MENU** button to open the MENU screen.
2. Use the **DATA** wheel to select (highlight) the **IMPORT/EXPORT** item, and press the **F4** [▶] button to open the **IMPORT/EXPORT** screen.



3. Use the **DATA** wheel to select (highlight) the **EXPORT MASTER** item, and press the **F4** [▶] button to open the **EXPORT MASTER** screen.



NOTE

A **Master Track Not Found** warning pop-up message appears if there is no stereo master track.

4. Edit the name (title) of the stereo master file as necessary. (See “Editing names” on page 46.)
5. When done editing the file name, press the **F2** [EXEC] button to export a stereo master track as a single 16-bit, 44.1kHz stereo WAV file to the FAT partition.

The file name of the exported file is the name set in step 4 above plus the “.WAV” extension.

If you have previously exported a stereo master track with the same name (title), a **Duplicate name Are you sure?** (A file with the same name already exists. Are you sure that you want to overwrite it?) confirmation pop-up message appears.



Press the **F3** [YES] button to overwrite the old file.

Press the **F4** [NO] button to cancel the export and return to the previous screen where you can edit the name (title).

NOTE

To cancel exporting, press the **F1** [BACK] button.

6. Press the **HOME** button to reopen the Home Screen.
7. Connect this unit to a computer using a USB cable. (See “Connecting with a computer” on page 84.)
8. Use the computer to copy the stereo master file from the WAVE directory on the FAT partition of the unit to the computer.
9. After copying finishes, remove the USB cable using the proper procedures and disconnect the unit from the computer. (See “Disconnecting” on page 85.)

13 – Troubleshooting

When working with any new piece of equipment like the unit, it's sometimes difficult to work out why something isn't happening the way you expect. The main thing is to take your time—after all, you're not paying hourly studio rates! Stop and think. Ask yourself questions, like the ones below, and you can usually find the answer.

Also, see the “Messages Lists” section on page 94 for the meaning of messages that may pop up on the display. Consult this table when a message appears when an operation cannot be completed by the unit.

Why can't I hear any sound when I play back?

- Are the **LEVEL** knobs of the tracks set to high enough?
- Is the **MASTER LEVEL** knob set to high enough?
- Have you properly connected the Ω /**LINE OUT** jack to headphones or an external monitoring system (powered monitor speakers or an amplifier and speakers)?
Is the external monitoring system set up correctly?
- Has the **VOLUME** dial on the left side of the unit been raised to a suitable level?

Why does the sound I'm recording sound distorted?

- Are the **LEVEL** knobs of the **INPUT A** or **INPUT B** on the top panel of the unit set too high? Is the input source too loud?
- Is the monitoring level too high, causing distortion from the external monitoring system (powered monitor speakers or an amplifier and speakers)?

Why can't I record?

- When you press the Play (▶) button while pressing and holding the Record (●) button to start recording, is at least one track in recording standby (**REC** indicator lit)?
- Are inputs assigned to tracks? (See “Assigning inputs” on page 54.)

Why can't my computer “see” the unit files?

- Is the unit connected to the computer via the USB terminal? (See “Connecting with a computer” on page 84.)
- Before making the USB connection, songs, tracks, or stereo masters are backed up or exported to the FAT partition?
Files on an MTR partition cannot be accessed directly from a computer.

When using the AC adaptor, noise occurs if I connect a passive guitar or bass directly.

- Connecting another device to the unit's Ω /**LINE OUT** jack might reduce the noise.
- This might be caused by interference noise from another device. If there is a power amplifier or other device that uses a large transformer, a fluorescent light or something similar nearby, you might be able to reduce the noise by changing the distance and orientation of this unit in relation to such equipment.

14 – Message Lists

The following popup messages alert you to conditions that may arise while you are using the unit. Consult this table if you see something you do not understand.

Messages	Meaning and remedy
Battery Empty	The batteries have no remaining charge. This appears when the batteries have no remaining charge. Replace the batteries with new ones or use a TASCAM PS-P520 AC adapter (sold separately).
Battery Low	The batteries have little remaining charge. This appears if you try to start recording when the batteries are low. Replace the batteries with new ones or use a TASCAM PS-P520 AC adapter (sold separately).
Card Full	The SD card is full during recording. Export or delete unneeded data to make room on the card or use a different SD card.
Empty Export Track	There is no recorded data for the export track. This appears if you tried to export a track from the song that does not have any recordings. (See “Track import and export” on page 88.) Export tracks from songs with recordings.
File Not Found	The file cannot be found. This appears if you try to restore a song when the FAT Partition does not have any backed up songs. (See “Song backup and restoration” on page 86.)
I/O Too Short	The IN and OUT points are too close together. This appears if you try to activate repeat playback mode when the IN and OUT points are too close together. Make sure the IN and OUT points are at least 2 frames apart. (See “Using repeat playback” on page 66.)
Import File Not Found	The file you are trying to import cannot be found. You are trying to import a WAV file from the FAT partition when there are no WAV files there. (See “Importing to tracks” on page 88.) Connect the unit to a PC and transfer some files to the FAT partition for import.
Import File Too Large	The file you are trying to import is too large. You are trying to import a WAV file from the MTR partition that is too large for the remaining space on the partition. Free up some space on the (native) partition and try again.
In Bounce Mode	The unit is in BOUNCE mode. You tried to perform an action that cannot be done while in BOUNCE mode.
In Master Mode	The unit is in MASTER REC or MASTER PLAY mode. You tried to perform an action that cannot be done while in MASTER REC or MASTER PLAY mode.

Messages	Meaning and remedy
In Repeat Mode	The unit is in repeat playback mode. You tried to perform an action that cannot be done while in Repeat mode.
Invalid Card	The SD card installed in the card slot is in a format that cannot be used by this unit. Insert another SD card after turning the unit OFF or format the card (put in standby) by opening the MENU, selecting CARD and then selecting FORMAT.
It's too Large	The song file is too large. You are trying to backup a song file that is larger than the open space available on the FAT partition. (See "Song backup and restoration" on page 86.) Format the FAT partition (see "Reformatting FAT partitions" on page 82) or connect the unit to a computer and make more space on the partition by deleting unneeded files, for example.
Master Track Not Found	The stereo master track cannot be found. This appears if you try to export a stereo master track from a song that does not have one recorded. (See "Exporting stereo master tracks" on page 92.) Create a stereo master track and then export it.
Master Track Too Large	The stereo master track is too large. You tried to export a stereo master track that is larger than the open space available on the FAT partition. (See "Exporting stereo master tracks" on page 92.) Reformat the FAT partition (See "Reformatting FAT partitions" on page 82.) or connect the unit to a computer and delete unneeded files, for example, to make more space available.
No Disk Space	There is not enough space. This appears if you try to create or copy a song when the MTR partition does not have enough space. Delete songs (See "Erasing songs" on page 49.) or format the SD card (See "Formatting SD cards" on page 79.), for example, to make more space available.
No Master Trk	There is no master track. This appears if you try to select a stereo master track that does not exist as the source track when cloning tracks. (See "CLONE TRACK (track duplication)" on page 69.) Create a stereo master track or select a different source track.
No Song	There is no song. You are trying to load a song from a partition that has no songs on it. (See "Loading a saved song" on page 46.) Change partitions. (See "Selecting the active partition" on page 45.)

14 – Message Lists

Messages	Meaning and remedy
No Undo History	There is no undo operation history. There are no actions to be undone. (See “Erasing the operation history” on page 60.)
No SD Card	No SD card has been loaded. Turn OFF the unit (put it in standby) and then insert an SD card.
Not Stopped	The recorder is not stopped. This appears when the recorder is not stopped and you push the UN/REDO button or any other button that only functions when the recorder is stopped.
Now Recording	The unit is currently recording. This appears when you try to perform a menu action while recording. There are also other operations that cannot be done while recording.
Protected Card	The SD card installed in the unit is write-protected. To record or edit, turn off (in standby) the unit and un-protect the SD card.
Same Track	You have set the same track. In the clone track settings you have set the same track for both SOURCE TRK and DESTINATION TRK.
SD Size Error	The capacity of the SD card installed in the unit is too small for this unit to use. Use an SD card larger than 512 MB.
Song Protected	The song is protected. This message appears when you try to record to, edit or otherwise change a protected song. Remove protection from the song before trying to change it. (See “Protecting songs” on page 50.)
Too Many songs	It is not possible to create any more songs. You have 250 songs on one partition. You must delete some before you can create another song.
Track Full	Tracks have already been recorded. This appears if you try to import when all the tracks have been recorded. (See “Importing to tracks” on page 88.)
Trk Edit Fail	Track editing failed. After saving the song, restart the unit’s power and conduct the edit again.
Trk Too Short	The track is too short. This appears if you try to change the recorder to master recording mode when the IN and OUT points are less than four seconds apart. Set the IN and OUT points at least four seconds apart. (See “Setting IN and OUT points” on page 65.)

Messages	Meaning and remedy
Work Memory Full	<p>The virtual memory created for work on the SD card has become full.</p> <p>Even if the SD card has enough remaining memory space, this error may occur when you record a long song or edit a lot. You may be able to continue the work if you clear the history which may increase the open work memory. (See “Erasing the operation history” on page 60.)</p> <p>You may also be able to continue work by turning the unit off and then on again, which may increase the open work memory.</p>
Audio Rst Fail	<p>If any of these errors occur, turn the the unit power OFF and restart it.</p> <p>If these error message continue to appear, please contact the nearest retailer or TASCAM representative.</p>
Device Error	
FileErr	
I/F Error	
Mount Error	
SaveParam Fail	
SD-Card Error!	
SD Not Found	
SD Read Busy	
SD Write Busy	

15 – Specifications

Media and file systems

Recording media

SD card (512 MB–2 GB)

SDHC card (4 GB–32 GB)

File system

MTR partition: TASCAM original

FAT partition: FAT32

Inputs and outputs

Analog audio input and output

INPUT A jack

Connector: 6.3mm (1/4") TS standard jack

Input impedance:

10 k Ω or greater (when **INPUT A** switch set to **MIC/LINE**)

1 M Ω (when **INPUT A** switch set to **GUITAR**)

Standard input level: –10dBV

Maximum input level: +6dBV

Headroom: 16dB

INPUT B jack

Connector: 6.3mm (1/4") TS standard jack

Input impedance: 10k Ω or greater

Standard input level: –10dBV

Maximum input level: +6dBV

Headroom: 16dB

Built-in microphones

Omnidirectional x2

LINE OUT jack

Connector: 3.5mm (1/8") stereo mini jack

- When line is connected
Standard output level: –16dBV
Maximum output level: 0dBV
 - When headphone is connected
Standard output level: 15mW+15mW (THD+N 0.1% or less, 32 Ω load)
-

Data input and output

USB jack

Connector: USB Mini-B 4-pin

Format: USB 2.0 HIGH SPEED mass storage class

Audio performance

Frequency response

INPUT(**MIC/LINE**) → LINE OUT: 20Hz–20kHz, +1dB/–3dB

Distortion

INPUT(**LINE**) → LINE OUT: Less than 0.05%

S/N ratio

INPUT(**MIC/LINE**) → LINE OUT: More than 81dB

Operating requirements

For the latest information on compatible operating systems, check the TASCAM website (<http://tascam.com/>).

Supported operating systems

Windows XP, Windows Vista and Windows 7
Mac OS X 10.4.6 and later

General

Power

Four AA batteries (alkaline or nickel-metal hydride) or TASCAM PS-P520 AC adaptor (sold separately)

Power consumption

1W (maximum)

Continuous battery operation time (continuous use)

- When using alkaline batteries (EVOLTA)

Continuous operation	Note
About 8.0 hours	Using line input and recording
About 8.5 hours	Using headphones and playing back

(JEITA standards used for recording and playback)

- When using nickel-metal hydride batteries (eneloop)

Continuous operation	Note
About 9.0 hours	Using line input and recording
About 9.5 hours	Using headphones and playing back

(JEITA standards used for recording and playback)

Dimensions (W x H x D) (including protrusions)

155 x 41.5 x 107mm
8.70 x 1.63 x 4.98in.

Weight (w/o batteries)

360g / 0.79lbs

Operating temperature range

5–35°C

15 – Specifications

Backup memory

This unit backs up the following settings and retains them even when OFF (in standby).

The following PREFERENCE screen items

- Repeat Int
- Auto Pwr Save
- Contrast

Dimensions

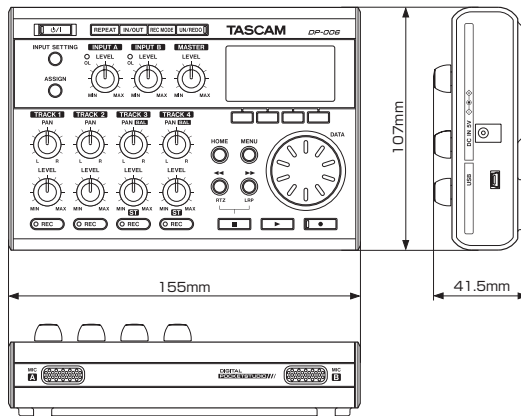

- Illustrations and other depictions may differ in part from the actual product.
- Specifications and external appearance may be changed without notification to improve the product.

Block diagram

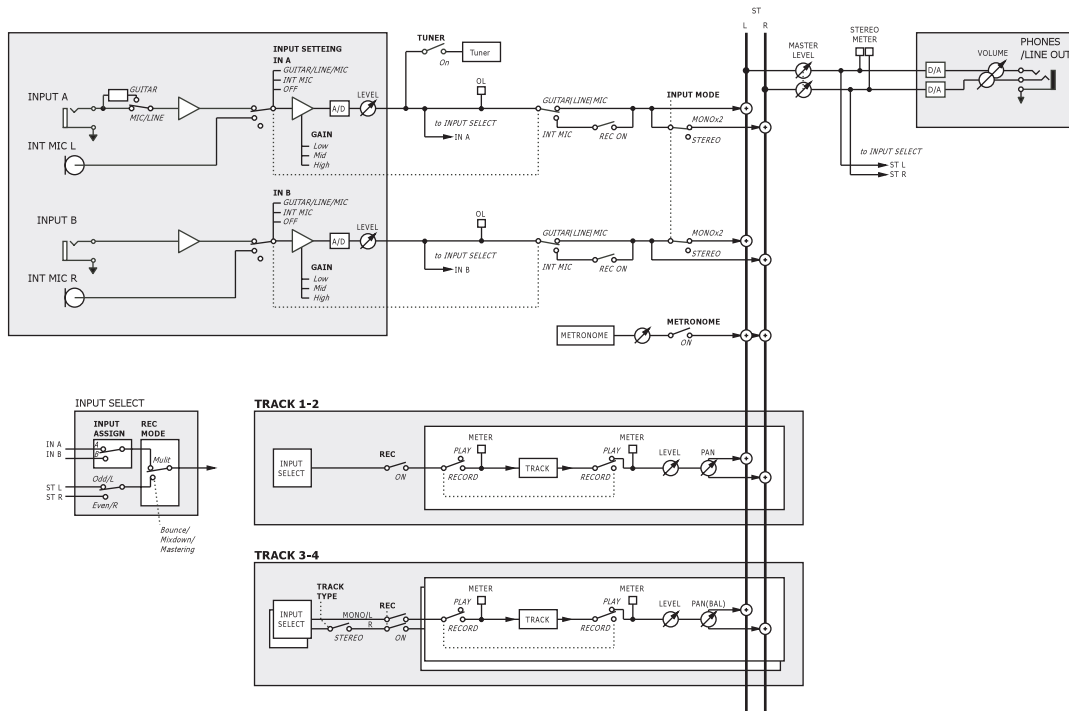

16 – Commonly-used Functions

This section is a brief guide to some operations on the DP-006 which may not be immediately obvious from looking at the panel controls.

- Button names are indicated like this: **REPEAT**.
- **MENU**→**CARD**→**FORMAT**, meaning “press the **MENU** button, select the **CARD** menu, and then the **FORMAT** action”.
- Complex operations are not shown completely in this table.

How to	Execution method (buttons used)	For details see
Format the FAT partition	MENU → CARD → FAT REFORMAT	“Reformatting FAT partitions” on page 82
Set the IN point /OUT point	IN/OUT , F3 , F4	“Setting IN and OUT points” on page 65
Edit the IN and OUT points	IN/OUT → F2	“Setting IN and OUT points” on page 65
Use the USB connection	Connect the unit and a PC with the USB cable.	“Connecting with a computer” on page 84
Remove the USB connection	Disconnect the unit from a PC	“Disconnecting” on page 85
Import a WAV file to a track	MENU → IMPORT/EXPORT → IMPORT TRACK	“Importing to tracks” on page 88
Choose another partition as the active partition	MENU → CARD → PARTITION	“Selecting the active partition” on page 45
Tune a guitar or bass	HOME → F1 [TUNER]	“Tuner” on page 76
Find out the current partition	MENU → INFORMATION	“Viewing song information” on page 48
Make all of an SD card usable by a PC	MENU → CARD → SD INITIALIZE	“Initializing SD cards” on page 82
Format an SD card	MENU → CARD → FORMAT	“Formatting SD cards” on page 79
Create a new song	MENU → SONG → CREATE	“Creating a new song” on page 47
Create a stereo master track	REC MODE → MASTER REC	“Creating stereo master tracks” on page 72
Export a stereo master track to a computer	MENU → IMPORT/EXPORT → EXPORT MASTER	“Exporting stereo master tracks” on page 92
Redo one operation	UN/REDO	“Undoing operations (undo)” on page 58
Undo one operation	UN/REDO	“Undoing operations (undo)” on page 58
Name a song	MENU → SONG → NAME EDIT	“Editing names” on page 46
Un-protect a song	MENU → SONG → PROTECT	“Protecting songs” on page 50
Display the song name (title)	MENU → INFORMATION	“Viewing song information” on page 48
Copy a song	MENU → SONG → COPY	“Copying songs” on page 48
Delete a song	MENU → SONG → ERASE	“Erasing songs” on page 49
Back up a song to a PC	MENU → DATA BACKUP → SONG BACKUP	“Song backup and restoration” on page 86
Protect a song	MENU → SONG → PROTECT	“Protecting songs” on page 50

16 – Commonly-used Functions

How to	Execution method (buttons used)	For details see
Save a song	MENU → SONG → SAVE	"Saving a song" on page 47
Load a song	MENU → SONG → LOAD	"Loading a saved song" on page 46
Delete the whole of a track	MENU → TRACK EDIT → CLEAN OUT	"CLEAN OUT (track erase)" on page 70
Insert silence at a point in a track	MENU → TRACK EDIT → OPEN	"OPEN (insert silence)" on page 71
Cut and close up part a track	MENU → TRACK EDIT → CUT	"CUT (remove part)" on page 71
Remove a section of a track and replace it with silence	MENU → TRACK EDIT → SILENCE	"SILENCE (part erase)" on page 70
Make a copy of a track	MENU → TRACK EDIT → CLONE TRACK	"CLONE TRACK (track duplication)" on page 69
Export a track's contents to PC	MENU → IMPORT/EXPORT → EXPORT TRACK	"Exporting tracks" on page 90
Bounce tracks	REC MODE → BOUNCE	"Bouncing tracks" on page 61
Format one partition	MENU → CARD → REFORMAT	"Reformatting MTR partitions" on page 81
Restore a song from a computer	MENU → DATA BACKUP → SONG RESTORE	"Song backup and restoration" on page 86
Ping-pong (bounce) to other tracks	REC MODE → BOUNCE	"Bouncing tracks" on page 61
Metronome settings	MENU → METRONOME	"Metronome" on page 75
Use the metronome	MENU → METRONOME	"Metronome" on page 75
Find out how much time is left for recording	MENU → INFORMATION	"Viewing song information" on page 48
Playback a created stereo master track	REC MODE → MASTER PLAY	"Checking stereo master tracks" on page 74
Use the built-in mic	INPUT SETTING	"Selecting the input source" on page 51
Record a guitar	INPUT SETTING	"Selecting the input source" on page 51
Monitor the input signal in mono (or stereo)	INPUT SETTING → MODE	"Setting the monitoring mode" on page 52
Change the track to which INPUT A/B is assigned	ASSIGN	"Assigning inputs" on page 54
Change the repeat interval used during repeat playback	MENU → PREFERENCE	"Setting the time between repetitions (repeat interval)" on page 66
Use the automatic power saving function	MENU → PREFERENCE	"Automatic power saving function" on page 77
Change the display contrast	MENU → PREFERENCE	"Adjusting the contrast" on page 44

TASCAM

DP-006

User registration

Customers in the USA, please visit the TASCAM website (<http://tascam.com/>) to register as a user online.

TEAC CORPORATION

Phone: +81-42-356-9143

1-47 Ochiai, Tama-shi, Tokyo 206-8530 Japan

<http://tascam.jp/>

TEAC AMERICA, INC.

Phone: +1-323-726-0303

7733 Telegraph Road, Montebello, California 90640 USA

<http://tascam.com/>

TEAC MEXICO, S.A. de C.V.

Phone: +52-55-5010-6000

Río Churubusco 364, Colonia Del Carmen, Delegación Coyoacán, CP 04100, México DF, México

<http://teacmexico.net/>

TEAC UK LIMITED

Phone: +44-8451-302511

Suites 19 & 20, Building 6, Croxley Green Business Park, Hatters Lane, Watford, Hertfordshire. WD18 8TE, U.K.

<http://tascam.eu/>

TEAC EUROPE GmbH

Phone: +49-611-71580

Bahnstrasse 12, 65205 Wiesbaden-Erbenheim, Germany

<http://tascam.eu/>

Printed in China